

PADERNO[®]

WORLD CUISINE

Partner of the Best Cuisine

2016 / 2017



LEGENDA KEY LEGEND



NUOVI PRODOTTI
NEW PRODUCTS



PRODOTTI CERTIFICATI NSF
NSF CERTIFIED PRODUCTS



PER COTTURA A INDUZIONE
SUITABLE FOR INDUCTION STOVE



PER COTTURA ELETTRICA
SUITABLE FOR ELECTRIC STOVE



PER COTTURA RADIANTE (VETROCERAMICA)
SUITABLE FOR RADIANT (CERAMIC-GLASS) STOVE



PER COTTURA A GAS
SUITABLE FOR GAS STOVE



IDONEO PER FORNO
FOR OVEN



NON IDONEO PER FORNO
DO NOT USE IN OVEN



IDONEO PER MICROONDE
FOR MICROWAVE OVEN



NON IDONEO PER MICROONDE
NOT USE IN MICROWAVE OVEN



NON METTERE A DIRETTO CONTATTO CON LA FIAMMA
DO NOT PLACE ON DIRECT FLAME



LAVABILE IN LAVASTOVIGLIE
DISHWASHER SAFE



NON IDONEO AL LAVAGGIO IN LAVASTOVIGLIE
NO DISHWASHER SAFE



REFRIGERABILE
WHIT COOLING UNIT



IMPILABILE
STACKABLE



RESISTENTE ALL'ACQUA
WATERPROOF



PER ALIMENTI
SUITABLE FOR FOOD CONTACT



SENZA BISFENOLO A
BPA FREE



PRIVO DI AGENTI TOSSICI
TOXIC AGENTS FREE



MATERIALE COMPOSITO (POLIAMMIDE E FIBRA DI VETRO)
COMPOSITE MATERIAL (POLYAMIDE AND FIBERGLASS)



PRODOTTO REALIZZATO IN RATTAN
PRODUCT MADE OF RATTAN



PRODOTTO REALIZZATO IN RATTAN SINTETICO
PRODUCT MADE OF SYNTHETIC RATTAN



MELAMINA
MELAMINE



COPOLIMERO STIRENE - ACRILONITRILE
COPOLYMER, STYRENE-ACRYLONITRILE



SUGGERITO ANCHE PER LA VENDITA AL DETTAGLIO
PRODUCT SUGGESTED ALSO FOR RETAIL



FACTORY

Fondata nel 1925 come "Alluminio Paderno" e specializzata nella produzione di pentole in alluminio per il settore casalingo, Paderno è attualmente un marchio leader a livello mondiale nella fabbricazione e commercializzazione di pentolame professionale e articoli da cucina per la ristorazione e per l'industria dell'ospitalità.

Nel 1997, in seguito all'acquisizione di Sambonet da parte di Paderno s.r.l. nasce Sambonet Paderno Industrie S.p.A.. Sambonet rappresenta dalla metà dell'ottocento l'eccellenza italiana, a livello internazionale, nella produzione di posateria e vasellame argentato e in acciaio inox dagli stili più classici fino alle sperimentazioni di design.

Paderno e Sambonet approdano nel 2001 a Orfengo (Novara), costituendo il quartier generale del Gruppo in un nuovo e moderno stabilimento firmato dall'Architetto Enrico Frigerio. Nell'azienda si concentrano non solo le attività produttive, il magazzino, un moderno laboratorio, ma anche gli uffici, lo showroom, l'outlet e un'area ricreativa dedicata ai dipendenti.

Nel 2009, con l'acquisto della prestigiosa società tedesca Rosenthal, Sambonet Paderno Industrie S.p.A. arricchisce il proprio portafoglio marchi (Sambonet, Paderno e Arthur Krupp) integrandolo con prestigiosi brand tedeschi del settore della porcellana come Rosenthal, Thomas e Hutschenreuther e, nel 2013, Arzberg. Il Gruppo italiano è ora leader nella produzione di articoli di design di alta qualità per la tavola e la cucina destinato a soddisfare tutte le esigenze dei canali Ho.Re.Ca. e dettaglio.

I prodotti Paderno sono distribuiti attraverso rivenditori specializzati in tutti i comparti della ristorazione Ho.Re.Ca. (come ristoranti, fastfood, alberghi e comunità, ospedali, navi da crociera ed enti militari). Forte di oltre 80 anni di storia con la sua presenza capillare in tutto il mondo, Paderno si propone internazionalmente come un punto di riferimento indispensabile per tutti i professionisti della ristorazione. Gli articoli di produzione sono inoltre affiancati da un'importante gamma di prodotti complementari e affini accuratamente selezionati e realizzati da ditte altamente qualificate.

Ho.Re.Ca.

Tel. 0321 879.601

Tel. 0321 19.16.822

Fax 0321 879.890

Fax 0321 19.16.845

horeca@paderno.it

horeca@sambonet.it

Retail

Tel. 0321 879.701

Tel. 0321 19.16.821

Fax 0321 879.830

Fax 0321 19.16.830

retail@paderno.it

retail@sambonet.it

Customer Service

Tel. 0321 879.630

Tel. 0321 19.16.824

Fax 0321 879.847

Fax 0321 19.16.847

resi@paderno.it

resi@sambonet.it

www.paderno.it

www.hotel.paderno.it

Founded in 1925 under the name of "Alluminio Paderno" and specialised in the production of aluminium pots and pans for the household, today Paderno is a leading international brand in the manufacture and sale of professional cookware and kitchen items for the restaurant and hospitality industry.

The 1997 saw the set-up of Sambonet Paderno Industrie S.p.A., following the acquisition of Sambonet by Paderno s.r.l.. Since the mid-nineteenth century, Sambonet has been a standard-bearer for Italian excellence throughout the world, producing flatware and holloware in silver-plated and stainless steel, from a classic to a modern and design-driven style.

In 2001, Paderno and Sambonet arrived in Orfengo (Novara), where the headquarters of the Group were set up in a new and modern plant designed by architect Enrico Frigerio. This facility houses not only the factory, the warehouse and a modern laboratory, but also the showroom, the outlet store and a recreation area for staff.

In 2009, the acquisition of the prestigious German company Rosenthal allowed Sambonet Paderno Industrie S.p.A. to enhance its brand portfolio (Sambonet, Paderno and Arthur Krupp) with the addition of leading names in the porcelain sector, including Rosenthal, Thomas and Hutschenreuther, in 2013, Arzberg. The Italian Group now plays a leading role in the production of top-quality items for the tabletop and the kitchen, aimed at covering all the needs required by the market.

Paderno products are distributed through specialised distributors in all segments of the hospitality industry (such as restaurants, fast food outlets, hotels and community facilities, hospitals, cruise ships and military bodies). The company's eighty-year history and the worldwide widespread presence makes Paderno an indispensable international benchmark for all professionals in the catering sector. A remarkable range of complementary articles, carefully selected and crafted by highly qualified companies, completes the Paderno produced collection.



GREEN & HUMAN

Il rispetto dell'ambiente e della persona sono temi rilevanti all'interno della responsabilità d'impresa di Sambonet Paderno Industrie S.p.A. Il Gruppo ha impostato e sviluppa tutt'oggi la propria evoluzione con un impegno di crescita sostenibile garantendo condizioni lavorative che possano soddisfare i bisogni delle persone nei differenti momenti della loro vita aziendale e applicando soluzioni volte a diminuire l'impronta ecologica. In quest'ottica, la gestione dei consumi energetici, elettrici e idrici è orientata a:

- impiegare energia elettrica pulita e rinnovabile;
- utilizzare il metano come unica fonte di combustibile;
- servirsi, per la produzione, di acqua di falda da restituire all'ambiente completamente depurata;
- usare tecnologia di risparmio energetico avanzata.

SUSTAINABILITY REPORT

Sambonet Paderno Industrie S.p.A. lavora per attuare forme di misurazione che siano in grado di documentare la puntualità, la trasparenza e l'impegno messo in atto per uno sviluppo sostenibile. Da qui la creazione della propria carta dei principi, 10 principi, 10 impegni su cui, attraverso un approccio preventivo e una gestione responsabile, l'Azienda costruisce il proprio futuro industriale.

Bilancio di Sostenibilità dell'Azienda
corporate.sambonet.it/csr.html

UNI EN ISO 14001:2004

La certificazione ambientale garantisce i risultati di una politica ambientale volta al continuo miglioramento delle proprie performance minimizzando ogni impatto negativo delle sue attività verso l'ambiente.

UNI EN ISO 50001:2011 - NEWS 2015

L'adesione volontaria alla norma UNI EN ISO 50001:2011 testimonia l'impegno e la visione dell'azienda verso l'ottimizzazione del consumo responsabile dell'energia, sia in termini economici auspicando a una riduzione dei consumi, e soprattutto verso una crescente attenzione ambientale diminuendo le emissioni di gas serra.

OHSAS 18001:2007

La certificazione ha l'obiettivo di tutelare la sicurezza e la salute dei propri lavoratori e dell'ambiente lavorativo. Sambonet Paderno Industrie S.p.A. è la prima Azienda appartenente al settore metalmeccanico ad ottenere l'attestazione.

The respect for the environment and for the people is a relevant issue for Sambonet Paderno Industrie S.p.A. Corporate Responsibility. The commitment to sustainable growth on which the Group was founded has been maintained and permits both to guarantee adequate working conditions in order to satisfy the changing needs of the staff and to apply solutions aimed at reducing the environmental impact. From this perspective, the management of energy, electricity and water consumption focuses on:

- *the use of electrical energy: clean, renewable and in harmony with the environment;*
- *the use of methane as the sole fuel source;*
- *the use of ground water for the manufacturing process, to be fully purified before being released into the environment;*
- *the use of an advanced energy-saving technology.*

Sambonet Paderno Industrie S.p.A. strives to implement forms of measurement to assess the punctuality, the transparency and the efforts made for sustainable development. This has led to the preparation of the corporate charter of principles, 10 principles, 10 commitments, on which the Company builds its industrial future from a perspective based on preventive approach and stewardship.

Corporate Sustainability Report
corporate.sambonet.it/csr.html

The UNI EN ISO 14001:2004 environmental certification is the recognition that the environmental policy results in a continuous improvement of environmental performance by minimising the negative impact of its operations on the environment.

The voluntary compliance with the standard UNI EN ISO 50001:2011 demonstrates the company's commitment and vision towards responsible energy consumption, factoring in both the economic hope of reducing consumption and, above all, the desire to increase environmental awareness about reducing greenhouse gas emissions.

The OHSAS 18001:2007 safety certification has the objective of protecting the safety of the workplace and the health of workers. Sambonet Paderno Industrie S.p.A. is the first Italian company in its sector that has obtained this certification.

PER LA CUCINA SENZA GLUTINE

Coerentemente all'ottica di servizio che contraddistingue il marchio, nasce e prende vita un nuovo progetto Paderno pensato per abbattere gli errori in cucina a salvaguardia del cliente celiaco, sviluppato e concretizzato in seguito alla collaborazione con l'Associazione Italiana Celiachia Lombardia ONLUS. Sambonet Paderno Industrie S.p.A. è stata la prima azienda del settore ad offrire al canale "fuori casa" una linea completa di articoli da destinare alla preparazione di pietanze senza glutine.

Attraverso alcuni elementi distintivi e differenzianti, come manici in PVD oro per pentole e padelle e personalizzazione con un logo specifico per utensili, tutti gli strumenti saranno facilmente identificabili in cucina. L'introduzione si pone come obiettivo:

- diminuire il rischio di accidentali contaminazioni crociate degli alimenti;
- facilitare il professionista nell'operare e nell'offrire un servizio a favore del cliente con intolleranza al glutine;
- sensibilizzare il settore sul tema "gluten free" di fronte alle nuove esigenze dei consumatori.

GLUTEN-FREE CUISINE

Consistently with the functional approach of the brand, a new Paderno project has been designed and implemented to reduce mistakes in the kitchen to the benefit of people with celiac disease. This project has been developed with the collaboration of Associazione Italiana Celiachia Lombardia ONLUS (Italian Society for the Celiac Disease - Lombardy Section). Sambonet Paderno Industrie S.p.A. is thus the first company in its industry that offers a full line of HoReCa items intended for gluten-free cooking.

Some distinguished special features, such as golden PVD handles for pans and pots and a special customised logo for utensils, will allow professionals to easily identify all these items in the kitchen. This innovation aims at:

- *reducing the risk of accidental food cross-contamination;*
- *making it easier for professionals to work and to provide services to clients with gluten intolerance;*
- *raising awareness on the gluten-free diet issue in the industry so as to respond to the new needs of consumers.*

CERTIFICATIONS

UNI EN ISO 22000

Prima nel suo settore Sambonet Paderno Industrie S.p.A. ha ottenuto la certificazione EN UNI ISO 22000:2005. Così come per l'intero comparto food and beverage, anche per il Gruppo la UNI EN ISO 22000:2005 rappresenta lo standard di più alto livello su scala internazionale. L'applicazione dei suoi requisiti, congiuntamente all'applicazione dell'HACCP (Hazard Analysis and Critical Control Points, sistema di autocontrollo igienico che previene i pericoli di contaminazione), garantisce alla clientela un servizio sicuro ed impeccabile attraverso una valutazione puntuale e scrupolosa delle condizioni igieniche e sanitarie delle attività e dei prodotti. Una garanzia di tutela non solo per il personale del canale professionale ma anche, e soprattutto, per il consumatore finale.

UNI EN ISO 22000

Sambonet Paderno Industrie is the first company in its industry that has been awarded the EN UNI ISO 22000:2005 certification. This certification attests to the highest international standard both for the Group and for the whole food and beverage industry. The implementation of its requirements, along with the implementation of HACCP (Hazard Analysis and Critical Control Points, a hygiene system that prevents contamination hazards), ensures the provision of a safe and impeccable service to customers by meticulously and scrupulously assessing the hygienic and safety conditions of activities and products. This is a guarantee not only for HoReCa professionals, but also, and foremost, for final consumers.

UNI EN ISO 9001:2008

La certificazione di qualità conforme ai requisiti della normativa internazionale garantisce la produzione e la commercializzazione di prodotti di qualità, che soddisfino pienamente i requisiti e le aspettative del cliente.

UNI EN ISO 9001:2008

This quality certification ensures compliance with the requirements of the international UNI EN ISO 9001:2008 standard, which guarantees the production and sale of quality products that fully meet customers' needs and expectations.

NSF

La certificazione è stata conseguita per alcuni prodotti grazie al superamento delle rigorose norme applicate negli USA circa i materiali a contatto con gli alimenti. Il marchio NSF (National Sanitation Foundation) è sinonimo di garanzia per i costruttori, ispettori ed utilizzatori.

NSF

Some products by Sambonet Paderno Industrie S.p.A. have obtained the prestigious NSF (National Sanitation Foundation) certification for compliance with the strict standards applied in the USA to materials in contact with foodstuffs. The NSF mark is a guarantee for manufacturers, inspectors and users.

GOST

La certificazione russa GOST (GOST R.), riconosciuta dall'Agenzia Federale per la Tecnica e la Metrologia GOSSTANDART per alcuni articoli, garantisce la conformità di tali prodotti rispetto agli standard applicati dal mercato russo. La sigla GOST è un'abbreviazione di "Gosudarstvennyj Standard" che in russo significa "Standard di Stato".

GOST

Some products by Sambonet Paderno Industrie S.p.A. have been awarded the Russian certification GOST (GOST R) by the Federal Agency for Technical Regulation and Metrology (aka GOSSTANDART), attesting to the compliance with the standards applied on the Russian market. The acronym GOST stands for "Gosudarstvennyj Standard", which means "State Standard" in Russian.

AEO

La certificazione comunitaria AEO Semplificazioni doganali e Sicurezza, conseguita nel 2008, garantisce un'attività disciplinata della regolamentazione doganale dell'azienda qualificandola in fatto di affidabilità e sicurezza nella catena di approvvigionamento internazionale. Nel 2011, inoltre, Sambonet Paderno Industrie S.p.A. ha ottenuto il mutuo riconoscimento del programma AEO con l'amministrazione doganale giapponese, condizione che favorisce ulteriormente i rapporti con il paese.

AEO

In 2008 Sambonet Paderno Industrie S.p.A. obtained the AEO Certification for Customs Simplifications and Security and Safety, valid for the EU. This programme provides a framework for governing customs regulations, guaranteeing that the company provides a reliable and secure service within the international supply chain. In addition, in 2011, Sambonet Paderno Industrie S.p.A. obtained the mutual recognition of the AEO programme with the Japanese customs administration, thus further improving customs relations with Japan.

MITTENTE CONOSCIUTO

L'approvazione "Mittente Conosciuto" rilasciata da ENAC (Ente Nazionale Aviazione Civile) riconosce l'Azienda come sito d'origine di merce idonea al trasporto su aeromobili di qualsiasi tipo, in conformità alle procedure e disposizioni comuni di sicurezza.

KNOWN CONSIGNOR

The "Known Consignor" approval issued by ENAC (Italian Civil Aviation Authority) certifies that the company is an originator of cargo suitable for carriage on any aircraft, in compliance with common safety procedures and provisions.

ECCELLENZA 2006

Certiquality ha attribuito a Sambonet Paderno Industrie S.p.A. il Certificato di Eccellenza per aver implementato un sistema di gestione integrata di Qualità, Ambiente e Sicurezza. L'ambito riconoscimento è ottenuto da poche aziende in Italia certificate ISO 9001, ISO 140001 e BS OHSAS 18001.

ECCELLENZA 2006

This prestigious certificate of Excellence, awarded by Certiquality to Sambonet Paderno Industrie S.p.A. for the implementation of an integrated Quality, Environmental and Safety management system, has been granted only to few companies in Italy that have obtained the ISO 9001, ISO 140001 and BS OHSAS 18001 certifications.

AWARD FOR EXCELLENCE

Nel 2006 Sambonet Paderno Industrie S.p.A. è stata insignita dell'Award for Excellence per l'innovazione, rilasciato da Confindustria in riferimento al framework per l'innovazione dell'EFQM-European Foundation for Quality Management.

AWARD FOR EXCELLENCE

In 2006 Sambonet Paderno Industrie S.p.A. received the Award for Excellence for Innovation by Confindustria (the main organization representing Italian manufacturing and services companies) with reference to the framework for innovation of the EFQM-European Foundation for Quality Management.



PRODUCTS

Gli articoli presenti nel catalogo Paderno sono realizzati con materiali di primissima qualità, dotati di tutti i requisiti di sicurezza e idoneità necessari per la loro commercializzazione. Nello specifico sono conformi:

- alla direttiva europea 1935/2004/CEE, relativa ai materiali e oggetti destinati al contatto con gli alimenti.
- alla normativa americana FDA (Food and Drug Administration) 21CFR 177.2600.

Gli articoli sono inoltre conformi alle seguenti norme:

A. OGGETTI METALLICI

Gli oggetti metallici o in lega metallica vengono realizzati seguendo le buone pratiche di fabbricazione (GMP Regolamento CE 2023/2006). In Italia gli articoli in acciaio inox, alluminio, banda stagnata e cromata devono essere conformi a una specifica normativa:

- in acciaio al DM 21/03/1973 aggiornato con il DM 258 del 21 dicembre 2010;
- in alluminio al DM 76 del 18 aprile 2007;
- in banda stagnata al DM del 18 febbraio 1984 smi;
- in banda cromata sono conformi al DM 246 del 1 giugno 1988.

B. OGGETTI IN CERAMICA

Gli oggetti in ceramica risultano essere idonei al contatto con gli alimenti rispondendo ai requisiti specifici stabiliti dal DM 4 aprile 1985 e smi (recepimento della Direttiva 84/500/CEE e 2005/31/CE).

C. OGGETTI VETRO E LEGNO

Gli oggetti in vetro e legno soddisfano i requisiti del DM 21/03/73 e smi.

D. MATERIALI PLASTICI

I prodotti realizzati in materiali plastici sono conformi a:

- al Regolamento n. 2002/72 (e suoi emendamenti) e al Regolamento 10/2011/UE (PIM);
- alla Direttiva CEE sui film di cellulosa rigenerata n. 93/10 e suoi emendamenti;
- alle raccomandazioni BfR (Bundesinstitut für Risikobewertung – Istituto federale tedesco per la valutazione del rischio);
- risultano essere conformi al DM 21/03/73, al Decreto 23/04/2009 (additivi), al Decreto 220 del 26/04/1993 ed al DM 338 del 22/07/98.

I materiali plastici vengono prodotti seguendo le buone pratiche di fabbricazione (GMP Regolamento CE 2023/2006).

E. PFOA FREE

Tutti i prodotti a catalogo in cui viene utilizzato il teflon come materiale antiaderente sono PFOA-free.

I. APPARECCHI ELETTRICI

Gli apparecchi elettrici presenti sul catalogo, salvo ove espressamente indicato, sono forniti secondo lo standard europeo sia per il voltaggio, sia per la presa. L'azienda è in grado di fornire ai clienti assistenza e preventivi ad hoc e suggerisce di richiedere, dal momento in cui gli standard possono variare da paese a paese, informazioni a riguardo.

The articles in the Paderno catalogue are made using top-quality materials and are compliant with all the safety and suitability requirements for sale. Specifically, they comply with:

- *European Directive 1935/2004/EEC about materials and objects in contact with foodstuffs.*
 - *FDA (Food and Drug Administration) Regulation no. 21CFR 177.2600.*
- The articles produced and sold by Sambonet Paderno Industrie S.p.A. comply with the following standards:*

A. METAL OBJECTS

Objects made of metal or metal alloy are made in accordance with good manufacturing practices (GMP Regulation EC 2023/2006). In Italy, items made of stainless steel, aluminium, tin plate and chromed plate must comply with some specific regulations:

- *steel items must comply with the Ministerial Decree of 21 March 1973, as updated by Ministerial Decree no. 258 of 21 December 2010;*
- *aluminium items must comply with Ministerial Decree no. 76 of 18 April 2007;*
- *tin plate items must comply with Ministerial Decree of 18 February 1984, as amended;*
- *chromed plate items must comply with Ministerial Decree no. 246 of 1 June 1988.*

B. CERAMIC OBJECTS

Ceramic objects are suitable for contact with foodstuffs, as they are compliant with the specific requirements set out in the Italian Ministerial Decree of 4 April 1985 as amended (which transposes Directives 84/500/EEC and 2005/31/EC).

C. GLASS AND WOODEN OBJECTS

Glass and wooden objects meet the requirements set out in the Italian Ministerial Decree of 21 March 1973 as amended.

D. PLASTIC MATERIALS

Products made of plastic materials comply with:

- *Regulation no. 2002/72 (and subsequent amendments) and Regulation no. 10/2011/EU (PIM);*
- *EEC Directive no. 93/10 on regenerated cellulose film and subsequent amendments;*
- *the recommendations from the BfR (Bundesinstitut für Risikobewertung – German Federal Institute for Risk Assessment);*
- *the Italian Ministerial Decree of 21 March 1973, the Decree of 23 April 2009 (additives), Decree no. 220 of 26 April 1993 and Ministerial Decree no. 338 of 22 July 1998.*

Plastic materials are made in accordance with good manufacturing practices (GMP Regulation EC 2023/2006).

E. PFOA FREE

All the products in the catalogue in which Teflon is used as a non-stick material are PFOA-free.

I. ELECTRICAL APPLIANCES

The electrical appliances featured in the catalogue (unless expressly indicated otherwise) are supplied in compliance with European standards as regards both voltage and plugs. The company can provide customers with assistance and specific cost estimates. The company suggests seeking relevant information, since standards may vary from one country to another.

ASEC LAB

ALIMENTARY
SECURITY
CONTROL
LABORATORY



Oltre alla conformità rispetto alle norme vigenti, gli articoli prodotti e commercializzati da Sambonet Paderno Industrie S.p.A. sono controllati in maniera sistematica.

Grazie alla costituzione di un gruppo di lavoro e del laboratorio interno ASEC Lab (Alimentary Security Control), specializzato nell'analisi di materiali destinati al contatto con gli alimenti, l'Azienda è in grado di garantire l'idoneità e la sicurezza dei propri prodotti. Il laboratorio è oggi accreditato per realizzare test di migrazione su acciaio, alluminio, porcellana, vetro, materiali plastici e coloranti per il rilascio di dichiarazioni di conformità, riconosciute da qualsiasi ente nazionale e internazionale. ASEC Lab è inoltre accreditato per la determinazione di pH, solventi e metalli nelle acque di scarico, una garanzia per le analisi interne sulla qualità delle proprie acque di scarico.

The items produced and sold by Sambonet Paderno Industrie S.p.A. not only comply with applicable regulations, but are also systematically tested. The Company can guarantee the suitability and safety of its products as it has established a specific workgroup and the ASEC Lab (Alimentary Security Control) internal laboratory, which analyses the materials intended to come into contact with foodstuffs.

The laboratory is now accredited to carry out migration testing on steel, aluminum, porcelain, glass, plastic materials and coloring in order to issue declarations of compliance, recognized by both national and international governments. The ASEC Lab is also accredited to determine pH levels, solvents and metals in water discharge, a guarantee for the internal analysis of the wastewater quality.

INDICE PRODOTTI - PRODUCT INDEX - PRODUKTINDEX



Pentolame
Cookware, pots & pans
Kochgeschirr
Batteries de cuisine
Baterías de cocina



Utensili da cucina
Kitchen utensils
Küchenzubehöre
Ustensiles de cuisine
Utensilios de cocina

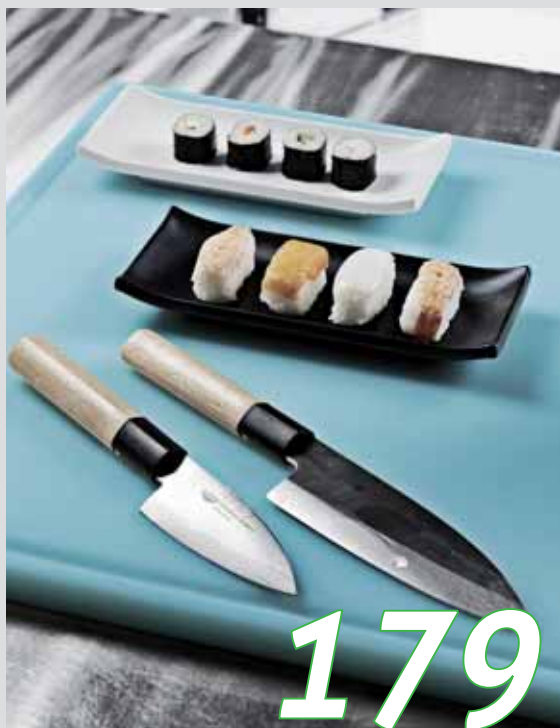

Coltelleria
Knives
Kochmesser
Coutellerie
Cuchilleria



Stoccaggio e trasporto
Storage & transport
Lagerung und Transport
Stockage & transport
Almacenamiento y transporte



245

Tavola
Table top service
Tischservice
Service de table
Servicio de mesa



296

Accessori tavola
Table accessories
Tischzubehör
Accessoires de table
Accesorios de mesa

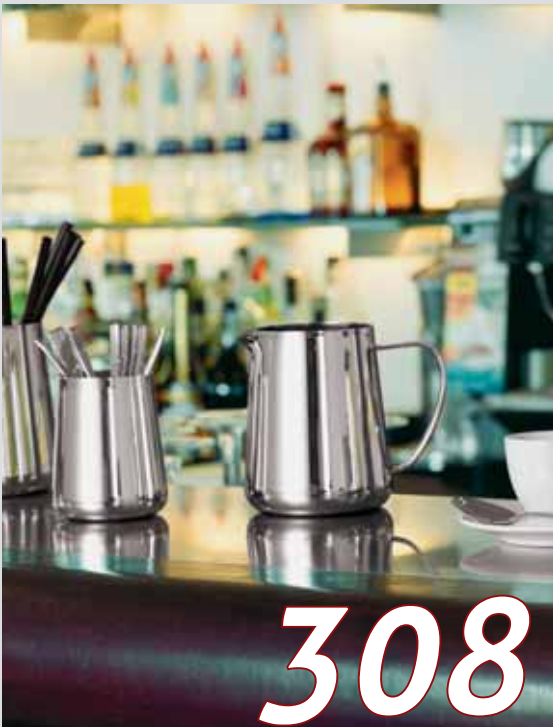

308

Utensili gelateria, bar, buffet e presentazione
Ice-Cream utensils, bar, buffet and presentation
Zubehör für Eiscreme, Bar, Buffet und Präsentation
Utensiles pour glace, bar, buffet et présentation
Heladería, bar, buffet y presentación



405

Pasticceria
Pastry utensils
Konditorei-Artikel
La pâtisserie
Pastelería





PENTOLAME
COOKWARE, POTS & PANS
KOCHGESCHIRR
BATTERIES DE CUISINE
BATERÍAS DE COCINA

SERIE 1100



Finitura esterna ed interna satinata, bordo lucido.
Manicatura tubolare in acciaio inox, anatomica, resistente al calore.
Bordo rinforzato.
Doppio spessore del fondo.
Fondo termodiffusore sandwich (inox-alluminio-inox).
Concavo a freddo e piano a caldo (sfruttamento del calore al 100%).
Ideali per ogni tipo di cottura, gas, elettrica, vetroceramica e induzione.
Tutti gli articoli sono dotati di speciale fondo termodiffusore adatto anche per piastre ad induzione.

*Outside and inside satin polished. Top edges mirror polished.
Hollow tubular stay cool handles in stainless steel, ergonomically shaped.
Extra thick edges.
Double thick bottom.
Sandwich thermoradiant bottom (stainless steel-aluminum-stainless steel).
Concave bottom when cold and flat when hot (100% heat exploiting).
Perfect for use on any type of stove, whether gas, electric, glass ceramic cooking surface or induction stove. All items have an induction-suited sandwich bottom.*



NSF

Pentola
Stock pot
Hoher Suppentopf
Marmite traiteur
Olla recta

art.	Ø cm.	h.	lt.
11101-16	16	16	3,2
11101-20	20	20	6,2
11101-24	24	24	10,0
11101-28	28	28	16,5
11101-32	32	32	24,0
11101-36	36	36	36,0
11101-40	40	40	50,0
11101-45	45	45	70,0
11101-50	50	50	100,0



NSF

Pentola bassa
Low stock pot
Gemüsetopf
Faitout
Olla recta baja

art.	Ø cm.	h.	lt.
11105-16	16	14	2,7
11105-20	20	17	5,0
11105-24	24	21	8,5
11105-28	28	23	14,5
11105-32	32	26	22,0
11105-36	36	28	29,0
11105-40	40	32	40,0



NSF

Casseruola alta
Saucepot
Fleischtopf
Brasière
Cacerola alta

art.	Ø cm.	h.	lt.
11107-16	16	11,0	2,1
11107-20	20	13,0	4,0
11107-24	24	15,0	6,5
11107-28	28	17,5	10,8
11107-32	32	19,5	15,7
11107-36	36	21,5	22,0
11107-40	40	24,5	30,8
11107-45	45	27,5	44,0
11107-50	50	32,0	63,0



NSF

Casseruola bassa
Casserole pot
Bratentopf
Sautoir
Cacerola baja

art.	Ø cm.	h.	lt.
11109-16	16	7,5	1,3
11109-20	20	8,0	2,5
11109-24	24	9,5	4,3
11109-28	28	11,0	6,7
11109-32	32	12,5	10,0
11109-36	36	14,0	14,2
11109-40	40	15,5	19,5
11109-45	45	17,0	27,0
11109-50	50	19,0	37,0



NSF

Colapasta per pentola
Colander for stock pot
Seiher für Suppentopf
Passoire pour marmite
Colador para olla recta

art.	Ø cm.	h.
11123-20	20	22,0
11123-24	24	26,5
11123-28	28	29,5

Per art. 11105 e art. 11101.
Suitable for both item 11105 and 11101.



Pentola con rubinetto
Stock pot with tap
Hochtopf mit Hahn
Marmite avec robinet
Olla con grifo

art.	Ø cm.	h.	lt.
11102-28	28	28	16,5
11102-32	32	32	24,0
11102-36	36	36	36,0
11102-40	40	40	50,0
11102-45	45	45	70,0
11102-50	50	50	100,0



NSF

Inserto a vapore, fondo forato
Steamer pot, perforated bottom
Dampf-Siebeinsatz
Casserole à vapeur, perforée
Parte superior de cuscusera

art.	Ø cm.	h.
11119-20	20	12,5
11119-24	24	15,0
11119-28	28	17,0
11119-32	32	19,0



11161

11119

11105



NSF

Casseruola alta
Saucepan
Stielkasserolle, hoch
Casserole haute
Cazo recto alto

art.	Ø cm.	h.	lt.
11106-14	14	8,0	1,2
11106-16	16	11,0	2,1
11106-20	20	13,0	4,0
11106-24	24	15,0	6,5
11106-28*	28	17,5	10,8
11106-32*	32	19,5	15,7
11106-36*	36	21,5	22,0

* Con contromaniglia. - With loop handle.



Casseruola bassa
Sauté pan
Stielkasserolle, niedrig
Plat à sauter
Cazo recto bajo

art.	Ø cm.	h.	lt.
11108-16	16	6,5	1,3
11108-20	20	8,0	2,5
11108-24	24	9,5	4,3
11108-28*	28	11,0	6,7
11108-32*	32	12,5	10,0
11108-36*	36	14,0	14,2

* Con contromaniglia. - With loop handle.



Casseruola conica
Sauté pan
Sauteuse
Sauteuse
Cazo cónico

art.	Ø cm.	h.	lt.
11112-16	16	6,0	1,0
11112-18	18	6,0	1,2
11112-20	20	6,5	1,6
11112-24	24	7,5	2,7



Casseruola "bombé"
Curved sauté pan
Sauteuse mit Schüttrand
Sauteuse bombé
Cazo bombeado

art.	Ø cm.	h.	lt.
11113-18	18	7,0	1,7
11113-20	20	7,5	2,2
11113-24	24	8,5	3,3
11113-26	26	9,0	4,2



Padella
Frypan
Bratpfanne
Poêle à frire
Sartén

art.	Ø cm.	h.
11114-20	20	5,0
11114-24	24	5,0
11114-28	28	5,5
11114-32	32	6,0
11114-36*	36	6,0
11114-40*	40	6,0
11114-45*	45	6,5

* Con contromaniglia. - With loop handle.



Padella, antiaderente
Frypan, non stick coating
Bratpfanne mit Antihftbeschichtung
Poêle avec revêtement anti-adhésif
Sartén antiaderente

art.	Ø cm.	h.
11117-20	20	5,0
11117-24	24	5,0
11117-28	28	5,5
11117-32	32	6,0
11117-36	36	6,0
11117-40	40	6,0



Tegame
French omelet pan
Pfanne
Poêle à paella
Paellera

art.	Ø cm.	h.
11115-20	20	5,0
11115-24	24	5,0
11115-28	28	5,5
11115-32	32	6,0
11115-36	36	6,0
11115-40	40	6,0
11115-45	45	6,5
11115-50	50	8,0



Coperchio, bordo rinforzato
Cover, reinforced edge
Deckel mit Randverstärkung
Couvercle, bord renforcé
Tapa, borde reforzado

art.	Ø cm.
11161-14	14
11161-16	16
11161-20	20
11161-24	24
11161-28	28
11161-32	32
11161-36	36
11161-40	40
11161-45	45
11161-50	50
11161-60	60



SERIE 2100

**INDUCTION
READY!**



La serie 2100 ha le stesse caratteristiche della serie 1100.
Differisce solo per una diversa manicatura sugli articoli a 2 maniglie.
Ideali per ogni tipo di cottura, gas, elettrica, vetroceramica e induzione.
Tutti gli articoli sono dotati di speciale fondo termodiffusore adatto
anche per piastre ad induzione.

*The serie 2100 has the same characteristics of the serie 1100.
It varies only for the shape of the handles of 2 handles items.
Perfect for use on any type of stove, whether gas, electric, glass ceramic
cooking surface or induction stove. All items have an induction-suited
sandwich bottom.*



Pentola
Stock pot
Hoher Suppentopf
Marmite traiteur
Olla recta

art.	Ø cm.	h.	lt.
12101-16	16	16	3,2
12101-20	20	20	6,2
12101-24	24	24	10,0
12101-28	28	28	16,5
12101-32	32	32	24,0
12101-36	36	36	36,0
12101-40	40	40	50,0
12101-45	45	45	70,0
12101-50	50	50	100,0



Casseruola alta
Saucepot
Fleischtopf
Brasière
Cacerola alta

art.	Ø cm.	h.	lt.
12107-16	16	11,0	02,1
12107-20	20	13,0	04,0
12107-24	24	15,0	06,5
12107-28	28	17,5	10,8
12107-32	32	19,5	15,7
12107-36	36	21,5	22,0
12107-40	40	24,5	30,8
12107-45	45	27,5	44,0
12107-50	50	32,0	63,0



Casseruola bassa
Casserole pot
Bratentopf
Sautoir
Cacerola baja

art.	Ø cm.	h.	lt.
12109-16	16	7,5	01,3
12109-20	20	08,0	02,5
12109-24	24	09,5	04,3
12109-28	28	11,0	06,7
12109-32	32	12,5	10,0
12109-36	36	14,0	14,2
12109-40	40	15,5	19,5
12109-45	45	17,0	27,0
12109-50	50	19,0	37,0

SERIE 1000



**INDUCTION
READY!**



Finitura esterna ed interna satinata.
Bordo a versare.
Manicatura tubolare in acciaio inox, anatomica, resistente al calore.
Parete e fondo a spessore uniforme.
Fondo termodiffusore sandwich (inox-alluminio-inox).
Concavo a freddo e piano a caldo (sfruttamento del calore al 100%).
Ideali per ogni tipo di cottura, gas, elettrica, vetroceramica e induzione.
Tutti gli articoli sono dotati di speciale fondo termodiffusore adatto anche per piastre ad induzione.

*Outside and inside satin polished.
Non-drip edge.
Hollow tubular stay cool handles in stainless steel, ergonomically shaped.
Uniform thickness in sides and bottoms.
Sandwich thermoradiant bottom (stainless steel-aluminum-stainless steel).
Concave bottom when cold and flat when hot (100% heat exploiting).
Perfect for use on any type of stove, whether gas, electric, glass ceramic cooking surface or induction stove. All items have an induction-suited sandwich bottom.*



Casseruola mezza alta
Saucepan
Stielkasserolle, mittelhoch
Casserole
Cazo recto francés

art.	Ø cm.	h.	lt.
11010-16	16	8	1,6
11010-18	18	9	2,3
11010-20	20	10	3,1
11010-24	24	12	5,4



Casseruola mezza alta
Saucepan
Stielkasserolle, mittelhoch
Casserole
Cazo recto francés

art.	Ø cm.	h.	lt.
11011-16	16	8	1,6
11011-18	18	9	2,3
11011-20	20	10	3,1
11011-24	24	12	5,4



Casseruola conica
Sauté pan
Sauteuse
Sauteuse
Cazo cónico

art.	Ø cm.	h.	lt.
11012-16	16	6,0	1,0
11012-18	18	6,0	1,2
11012-20	20	6,5	1,6
11012-24	24	7,5	2,7



Casseruola bombé
Curved sauté pan
Sauteuse mit Schüttrand
Sauteuse bombé
Cazo bombeado

art.	Ø cm.	h.	lt.
11013-18	18	7,0	1,7
11013-20	20	7,5	2,2
11013-24	24	8,5	3,3
11013-26	26	9,0	4,2



Pentola
Stock pot
Hoher Suppentopf
Marmite traiteur
Olla recta

art.	Ø cm.	h.	lt.
11001-16	16	16	3,2
11001-18	18	16	4,0
11001-20	20	18	5,5
11001-22	22	22	8,3
11001-24	24	24	10,5
11001-28	28	28	17,0
11001-32	32	32	25,5
11001-36	36	36	36,5
11001-40	40	40	50,0
11001-45	45	40	63,5
11001-50	50	50	98,0
11001-60	60	55	150,0



Casseruola alta
Saucepot
Fleischtopf
Brasière
Cacerola alta

art.	Ø cm.	h.	lt.
11007-16	16	9,5	1,9
11007-18	18	10,8	2,7
11007-20	20	12,0	3,8
11007-22	22	13,0	5,0
11007-24	24	14,5	6,5
11007-28	28	16,0	9,8
11007-32	32	19,5	15,4
11007-36	36	21,5	20,5
11007-40	40	24,0	30,1
11007-45	45	27,0	42,9
11007-50	50	30,0	58,0
11007-60	60	35,0	99,0



Casseruola bassa
Casserole pot
Bratentopf
Sautoir
Cacerola baja

art.	Ø cm.	h.	lt.
11009-16	16	6,5	1,3
11009-18	18	7,0	1,8
11009-20	20	7,5	2,5
11009-24	24	8,0	3,7
11009-28	28	9,5	5,8
11009-32	32	11,0	9,2
11009-36	36	13,0	13,0
11009-40	40	14,5	18,0
11009-45	45	15,5	24,6
11009-50	50	19,0	37,0
11009-60	60	25,0	70,7



Padella
Frypan
Bratpfanne
Poêle à frire
Sartén

art.	Ø cm.	h.
11014-20	20	5,0
11014-24	24	5,0
11014-28	28	5,5
11014-32	32	6,0
11014-36*	36	6,0
11014-40*	40	6,0
11114-45*	45	6,5

* Con contromaniglia. - With loop handle.



Padella, antiaderente
Frypan, non stick
Bratpfanne, nichttaftend
Poêle, anti-adhérente
Sartén antiaderente

art.	Ø cm.	h.
11117-20	20	5,0
11117-24	24	5,0
11117-28	28	5,5
11117-32	32	6,0
11117-36	36	6,0
11117-40	40	6,0



Tegame
French omelet pan
Pfanne
Poêle à paella
Paellera

art.	Ø cm.	h.
11115-20	20	5,0
11115-24	24	5,0
11115-28	28	5,5
11115-32	32	6,0
11115-36	36	6,0
11115-40	40	6,0
11115-45	45	6,5
11115-50	50	8,0



Casseruola alta
Saucepan
Stielkasserolle, hoch
Casserole haute
Cazo recto alto

art.	Ø cm.	h.	lt.
11006-12	12	7,0	0,8
11006-14	14	8,0	1,2
11006-16	16	9,5	1,9
11006-18	18	10,8	2,7
11006-20	20	12,0	3,8
11006-22	22	13,0	5,0
11006-24	24	14,5	6,5
11006-28*	28	16,0	9,8
11006-32*	32	19,5	15,4
11006-36*	36	21,5	20,5

* Con contromaniglia. - With loop handle.



Casseruola bassa
Sauté pan
Stielkasserolle, niedrig
Plat à sauter
Cazo recto bajo

art.	Ø cm.	h.	lt.
11008-16	16	6,5	1,3
11008-18	18	7,0	1,8
11008-20	20	7,5	2,5
11008-24	24	8,0	3,7
11008-28*	28	9,5	5,8
11008-32*	32	11,0	9,2
11008-36*	36	13,0	13,0

* Con contromaniglia. - With loop handle.



Coperchio, bordo rinforzato
Cover, reinforced edge
Deckel mit Randverstärkung
Couvercle, bord renforcé
Tapa, borde reforzado

art.	Ø cm.
11061-16	16
11061-18	18
11061-20	20
11061-22	22
11061-24	24
11061-28	28
11061-32	32
11061-36	36
11061-40	40
11061-45	45
11061-50	50
11161-60	60

SERIE 2000



La serie 2000 ha le stesse caratteristiche della serie 1000. Differisce solo per una diversa manicatura sugli articoli a 2 maniglie. Ideali per ogni tipo di cottura, gas, elettrica, vetroceramica e induzione. Tutti gli articoli sono dotati di speciale fondo termodiffusore adatto anche per piastre ad induzione.

The serie 2000 has the same characteristics of the serie 1000. It varies only for the shape of the handles of 2 handles items. Perfect for use on any type of stove, whether gas, electric, glass ceramic cooking surface or induction stove. All items have an induction-suited sandwich bottom.



Pentola
Stock pot
Hoher Suppentopf
Marmite traiteur
Olla recta

art.	Ø cm.	h.	lt.
12001-16	16	16	3,2
12001-18	18	16	4,0
12001-20	20	18	5,5
12001-22	22	22	8,3
12001-24	24	24	10,5
12001-28	28	28	17,0
12001-32	32	32	25,5
12001-36	36	36	36,5
12001-40	40	40	50,0
12001-45	45	40	63,5
12001-50	50	50	98,0
12001-60	60	55	150,0



Casseruola alta
Saucepot
Fleischtopf
Brasière
Cacerola alta

art.	Ø cm.	h.	lt.
12007-16	16	9,5	1,9
12007-18	18	10,8	2,7
12007-20	20	12,0	3,8
12007-22	22	13,0	5,0
12007-24	24	14,5	6,5
12007-28	28	16,0	9,8
12007-32	32	19,5	15,4
12007-36	36	21,5	20,5
12007-40	40	24,0	30,1
12007-45	45	27,0	42,9
12007-50	50	30,0	58,0
12007-60	60	35,0	99,0



Casseruola bassa
Casserole pot
Bratentopf
Sautoir
Cacerola baja

art.	Ø cm.	h.	lt.
12009-16	16	6,5	1,3
12009-18	18	7,0	1,8
12009-20	20	7,5	2,5
12009-24	24	8,0	3,7
12009-28	28	9,5	5,8
12009-32	32	11,0	9,2
12009-36	36	13,0	13,0
12009-40	40	14,5	18,0
12009-45	45	15,5	24,6
12009-50	50	19,0	37,0
12009-60	60	25,0	70,7



Inserto a vapore, fondo forato
Steamer pot, perforated bottom
Dampf-Siebeinsatz
Casserole à vapeur, perforée
Parte superior de cuscusera

art.	Ø cm.	h.
12119-20	20	12,5
12119-24	24	15,0
12119-28	28	17,0
12119-32	32	19,0



Colapasta per pentola
Colander for stock pot
Seiher für Suppentopf
Passoire pour marmite
Colador para olla recta

art.	Ø cm.	h.
12123-20	20	22,0
12123-24	24	26,5
12123-28	28	29,5



Pentola cuociasparagi
Asparagus-pot
Spargeltopf
Cuit-asperges
Olla espárragos

art.	Ø cm.	h.	lt.
12037-16	16	24	4,8



Casseruola mezza alta
Saucepan
Stielkasserolle, mittelhoch
Casserole
Cazo recto francés

art.	Ø cm.	h.	lt.
11011-16	16	8	1,6
11011-18	18	9	2,3
11011-20	20	10	3,1
11011-24	24	12	5,4



Casseruola conica
Sauté pan
Sauteuse
Sauteuse
Cazo cónico

art.	Ø cm.	h.	lt.
11012-16	16	6,0	1,0
11012-18	18	6,0	1,2
11012-20	20	6,5	1,6
11012-24	24	7,5	2,7



Casseruola "bombé"
Curved sauté pan
Sauteuse mit Schütterand
Sauteuse bombé
Cazo bombeado

art.	Ø cm.	h.	lt.
11013-18	18	7,0	1,7
11013-20	20	7,5	2,2
11013-24	24	8,5	3,3
11013-26	26	9,0	4,2



Casseruola alta
Saucepan
Stielkasserolle, hoch
Casserole haute
Cazo recto alto

art.	Ø cm.	h.	lt.
11006-12	12	7,0	0,8
11006-14	14	8,0	1,2
11006-16	16	9,5	1,9
11006-18	18	10,8	2,7
11006-20	20	12,0	3,8
11006-22	22	13,0	5,0
11006-24	24	14,5	6,5
11006-28*	28	16,0	9,8
11006-32*	32	19,5	15,4
11006-36*	36	21,5	20,5

* Con contromaniglia. - With loop handle.



Casseruola bassa
Sauté pan
Stielkasserolle, niedrig
Plat à sauter
Cazo recto bajo

art.	Ø cm.	h.	lt.
11008-16	16	6,5	1,3
11008-18	18	7,0	1,8
11008-20	20	7,5	2,5
11008-24	24	8,0	3,7
11008-28*	28	9,5	5,8
11008-32*	32	11,0	9,2
11008-36*	36	13,0	13,0

* Con contromaniglia. - With loop handle.



Padella
Frypan
Bratpfanne
Poêle à frire
Sartén

art.	Ø cm.	h.
11014-20	20	5,0
11014-24	24	5,0
11014-28	28	5,5
11014-32	32	6,0
11014-36*	36	6,0
11014-40*	40	6,0
11114-45*	45	6,5

* Con contromaniglia. - With loop handle.



Padella, antiaderente
Frypan, non stick coating
Bratpfanne mit Antihafbeschichtung
Poêle avec revêtement anti-adhésif
Sartén antiadherente

art.	Ø cm.	h.
11117-20	20	5,0
11117-24	24	5,0
11117-28	28	5,5
11117-32	32	6,0
11117-36	36	6,0
11117-40	40	6,0



Tegame
French omelet pan
Pfanne
Poêle à paella
Paellera

art.	Ø cm.	h.
11115-20	20	5,0
11115-24	24	5,0
11115-28	28	5,5
11115-32	32	6,0
11115-36	36	6,0
11115-40	40	6,0
11115-45	45	6,5
11115-50	50	8,0



Coperchio, bordo rinforzato
Cover, reinforced edge
Deckel mit Randverstärkung
Couvercle, bord renforcé
Tapa, borde reforzado

art.	Ø cm.
11061-16	16
11061-18	18
11061-20	20
11061-22	22
11061-24	24
11061-28	28
11061-32	32
11061-36	36
11061-40	40
11061-45	45
11061-50	50
11161-60	60



Pentola a pressione
Pressure cooker
Schnellkochtopf
Autocuiseur
Olla de presión

art.	Ø cm.	h.	lt.
49800-15	32	19	15

SERIE 2500 3-PLY

INDUCTION
READY!

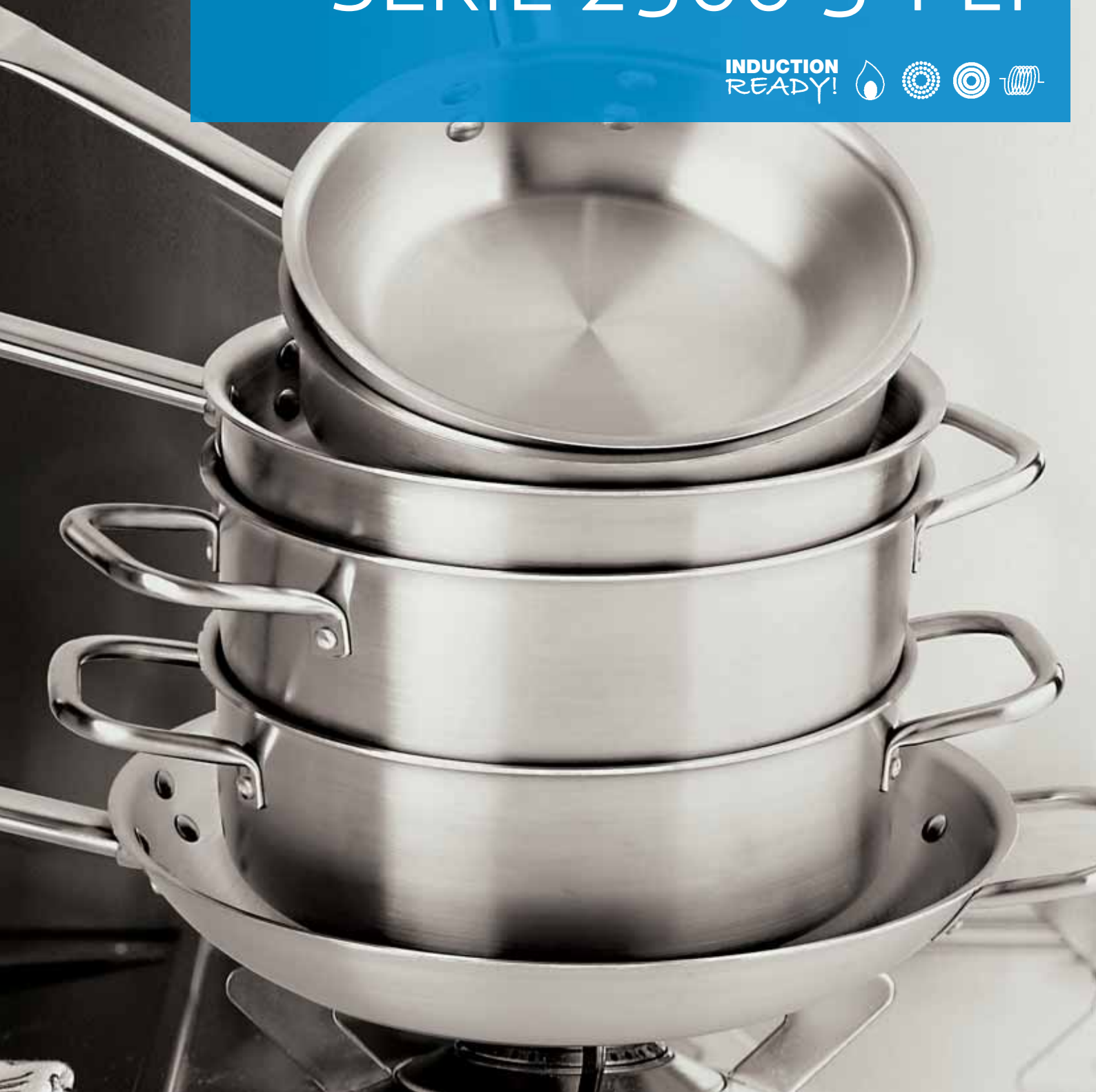

La serie Paderno 2500 3-ply concepita per l'utilizzo nelle cucine professionali è costruita in materiale multistrato che assicura una distribuzione rapida ed uniforme del calore su tutta la superficie dell'utensile.

Finitura esterna ed interna satinata.

Bordo a versare.

Manicatura anatomica in acciaio inox.

Parete e fondo a spessore uniforme.

Risparmio di energia su tutti i piani di cottura.

Ideali per ogni tipo di cottura inclusa l'induzione.

Paderno serie 2500 3-ply is especially designed for professional kitchens, features super heat-conductive multi-layer construction that distributes heat from bottom to rim quickly and evenly.

Outside and inside satin polished.

Non-drip edge.

Stainless steel handles, ergonomically shaped.

Uniform thickness in sides and bottoms.

Energy saving on all types of cookers.

Suitable for all cooking ranges, induction hobs included.



Casseruola alta
Saucepot
Fleischtopf
Brasière
Cacerola alta

art.	Ø cm.	h.	lt.
12507-24	24	11,5	5,0
12507-28	28	14,0	8,5



Casseruola bassa
Casserole pot
Bratentopf
Sautoir
Cacerola baja

art.	Ø cm.	h.	lt.
12509-20	20	9,5	2,8
12509-24	24	10,5	4,7
12509-28	28	11,0	6,5



Casseruola mezza alta
Saucepan
Stielkasserolle, mittelhoch
Casserole
Cazo recto francés

art.	Ø cm.	h.	lt.
12511-16	16	7,5	1,5
12511-18	18	8,0	2,0
12511-20	20	8,8	2,5
12511-24	24	10,5	4,6



Casseruola bassa
Sauté pan
Stielkasserolle, niedrig
Plat à sauter
Cazo recto bajo

art.	Ø cm.	h.	lt.
12508-24	24	5,0	2,0



Casseruola bombé
Curved sauté pan
Sauteuse mit Schüttrand
Sauteuse bombé
Cazo bombeado

art.	Ø cm.	h.	lt.
12513-16	16	6,0	1,2
12513-18	18	6,5	1,6
12513-20	20	7,0	2,0
12513-24	24	8,5	3,8



Padella
Frypan
Bratpfanne
Poêle à frire
Sartén

art.	Ø cm.	h.
12514-20*	20	3,0
12514-24	24	5,5
12514-26	26	5,5
12514-28	28	5,5
12514-32	32	4,0
12514-36	36	4,0

* Finitura lucida. - Mirror finishing.



Wok c/griglia e coperchio
Wok with grid and cover
Wok mit Rost und Deckel
Wok avec grille et couvercle
Wok con rejilla y tapa

art.	Ø cm.	h.
12529-32	32	8



Padella, antiaderente
Frypan, non stick coating
Bratpfanne mit Antihftbeschichtung
Poêle avec revêtement anti-adhésif
Sartén antiaderente

art.	Ø cm.	h.
12517-24	24	5,5
12517-26	26	5,5
12517-28	28	5,5
12517-32	32	5,5
12517-36	36	5,5



Coperchio
Cover
Deckel
Couvercle
Tapa

art.	Ø cm.
12561-16	16
12561-18	18
12561-20	20
12561-24	24
12561-26	26
12561-28	28



Casseruola alta, con coperchio
Saucepot with lid
Fleischtopf mit Deckel
Brasière avec couvercle
Cacerola alta con tapa

art.	Ø cm.	h.	lt.
12509-12	12	6	0,7



Casseruola bassa
Sauté pan
Stielkasserolle, niedrig
Plat à sauter
Cazo recto bajo

art.	Ø cm.	h.	lt.
12511-12	12	6	0,7
12511-14	14	7	1,0



Casseruola bassa con doppio becco
Sauté pan with double spouts
Stielkasserolle, niedrig, 2 Schnabel
Plat à sauter, 2 becs
Cazo recto bajo, 2 picos

art.	Ø cm.	h.	lt.
12511-10	10	5,0	0,4

Finitura lucida. - Mirror finishing.

COMPLEMENTI BAKING PANS



Tegame
Roasting pan
Bräter
Plaque à rôtir
Rustidera

art.	dim. cm.	h.
11941-35	35x25	8
11941-40	40x26	9
11941-45	45x30	9
11941-50	50x30	9
11941-60*	60x35	9

*Per forno GN 2/1. - For 2/1 GN ovens.

Tegame pesante
Heavy roasting pan
Bräter, Schwerausführung
Plaque à rôtir lourde
Rustidera pesada

art.	dim. cm.	h.
11943-40	40x26	9
11943-45	45x30	9
11943-50	50x30	9
11943-60	60x35	9
11943-61*	61x43	9

*Per forno GN 2/1. - For 2/1 GN ovens.

Tegame pesante
Heavy roasting pan
Bräter, Schwerausführung
Plaque à rôtir lourde
Rustidera pesada

art.	dim. cm.	h.
11944-40	40x26	9
11944-45	45x30	9
11944-50	50x30	9
11944-60	60x35	9
11944-61*	61x43	9

*Per forno GN 2/1. - For 2/1 GN ovens.



NSF

Coperchio
Lid
Deckel
Couvercle
Tapa

art.	dim. cm.
11948-40	40x26
11948-45	45x30
11948-50	50x30
11948-60	60x35
11948-61*	61x43

*Per forno GN 2/1 - For 2/1 GN ovens



Lasagnera
Lasagne pan
Lasagneschale
Bac à lasagne
Rustidera sin asas

art.	dim. cm.	h.
11940-30	30x18	6,0
11940-40	40x24	7,0
11940-45	45x28	7,5



Gratin ovale
Oval gratin pan
Gratinschüssel, oval
Plat à gratiner ovale
Fuente honda oval

art.	dim. cm.	h.
11939-27	27x14	3,8
11939-30	30x17	3,8
11939-40	40x23	3,8
11939-45	45x26	3,8



NSF

Brasiera con coperchio
Roasting pan with cover
Brasiere mit Deckel
Braisière avec couvercle
Rustidera alta con tapa

art.	dim. cm.	h.
11965-50	50x30	15
11965-60	60x35	15
11965-61*	61x43	15

*Per forno GN 2/1. - For 2/1 GN ovens.



Pesciera
Fish kettle
Fischkochkessel
Poissonnière
Hervidor pescado

art.	dim. cm.	h.	lt.
11963-60	60x20	14	14
11963-70	70x21	16	20
11963-99	100x25	20	44

Fornita completa di griglia e coperchio.
Equipped with grid and cover.



Pesciera
Fish kettle
Fischkochkessel
Poissonnière
Hervidor pescado

art.	dim. cm.	h.
41964-45	47x16	11,5
41964-60	61x19	12,5

Fornita completa di griglia e coperchio.
Equipped with grid and cover.



Contenitore cilindrico
Canister
Behälter
Bahut
Contenedor cilíndrico

art.	Ø cm.	h.	lt.
11913-16	16	12	2,4
11913-20	20	16	5,0
11913-24	24	20	9,0
11913-28	28	24	14,5



NSF

Casseruola bagnomaria
Bain-marie pot
Wasserbadkasserolle
Casserole bain-marie
Baño maria

art.	Ø cm.	h.	lt.
11910-12	12	14	1,4
11910-14	14	16	2,5
11910-16	16	18	3,6
11910-18	18	20	5,0
11910-20	20	22	7,0



Bagnomaria
Bain-marie pot
Behälter
Casserole bain-marie
Baño maria

art.	Ø cm.	h.	lt.
11911-12	12	14	1,4
11911-14	14	16	2,5
11911-16	16	18	3,6
11911-18	18	20	5,0
11911-20	20	22	7,0



Bollitore
 Whistling kettle
 Kocher
 Bouilloire à sifflet
 Pava

art.	lt.
41914-03	2,8



Rete paraspruzzi
 Splatter screen
 Pfannenspritzschutz
 Ecran antisplash
 Red antispicadura

art.	Ø. cm.
11917-28	28
11917-34	34

Manico ABS. - ABS handle.



Coperchio bagnomaria
 Bain-marie lid
 Wasserbadkasserolle-Deckel
 Couverte pour bain-marie
 Tapa para baño maria

art.	dim. cm.
44501-04	24x24
44502-04	15,5x15,5
44503-04	15,5x10,5



Bagno-maria impilabili
 Bain-marie, stackable
 Bain-Marie, stapelbar
 Bain-marie, empilables
 Baño maria, apilable

art.	dim. cm.	h.	lt.
44501-01	24x24	23,5	13
44501-02	24x24	16	9
44501-03	24x24	7,5	4



Bagno-maria impilabili
 Bain-marie, stackable
 Bain-Marie, stapelbar
 Bain-marie, empilables
 Baño maria, apilable

art.	dim. cm.	h.	lt.
44502-01	15,5x15,5	23,5	5,0
44502-02	15,5x15,5	16,0	3,5
44502-03	15,5x15,5	7,5	1,5



Bagno-maria impilabili
 Bain-marie, stackable
 Bain-Marie, stapelbar
 Bain-marie, empilables
 Baño maria, apilable

art.	dim. cm.	h.	lt.
44503-01	15,5x10,5	16,0	2,5
44503-02	15,5x10,5	7,5	1,0
44503-03	15,5x10,5	5,5	0,5



Robusti e maneggevoli, non scottano. Efficienti, la nuova rete aumenta la velocità di colatura e consente di colare anche il riso senza disperdere i chicchi. *Strong and handy, stay cool grip, efficient, the new gauze improves the speed of strain and also perfect for rice.*



Colapasta 1/4
 1/4-Segment colander
 1/4 Seiher-Einsatz
 Passoire cuit-pâtes, 1/4
 Colador 1/4

art.	Ø cm.	h.	lt.
11922-36	36	23	5,5
11922-40	40	26	7,5



Colapasta 1/4 a rete, manico silicone
 1/4-Segment wire colander, silicone handle
 1/4 Netzseiher-Einsatz
 Passoire cuit-pâtes à gaze, 1/4
 Colador red 1/4

art.	Ø cm.	h. cm.
11923-36	36	23



Colapasta 1/4 a rete
 1/4-Segment wire colander
 1/4 Netzseiher-Einsatz
 Passoire cuit-pâtes à gaze, 1/4
 Colador red 1/4

art.	Ø cm.	h. cm.
12992-36	36	23
12992-40	40	26

PA⁺
plus

Adatti alle casseruole art. 11007-11107-12007-12107-16929 - Accessorio indispensabile in cucina. E' possibile cuocere la pasta o sbollentare le verdure ma soprattutto ideale per poter preparare diversi tipi di pasta con diverse cotture contemporaneamente. Uno spicchio può essere utilizzato per cuocere gli gnocchi e un altro per gli spaghetti inseriti entrambi nella stessa casseruola.

Suit sauce-pots items: 11007-11107-12007-12107-16929 - An essential kitchen accessory. To cook pasta or blanching vegetables. Especially to prepare at the same time different types of pasta with different cooking time. A segment can be used to cook gnocchi and another one spaghetti both cooking in the same pot.

SERIE 6100 CRUDALLUMINIO



Esecuzione in alluminio pesante, per cucine elettriche e a gas.
Manicatura tubolare in acciaio inossidabile 18/10, resistente al calore.
Ampio raggio di raccordo fondo-parete, igienico e facile da pulire.
Spessore da mm 2 a mm 5,5.

*Made in heavy duty aluminum, suitable both for electric and gas stoves.
Hollow tubular handles in stainless steel 18/10, stay cool.
Rounded corners provide easy cleanup.
Thickness from mm 2 to mm 5,5.*



Pentola
Stock pot
Hoher Suppentopf
Marmite traiteur
Olla recta

art.	Ø cm.	h.	lt.
16101-16	16	16	3,2
16101-20	20	20	6,2
16101-24	24	24	10,0
16101-28	28	28	16,5
16101-32	32	32	24,0
16101-36	36	36	36,0
16101-40	40	40	50,0
16101-45	45	45	70,0
16101-50	50	50	100,0



Casseruola alta
Saucepot
Fleischtopf
Brasière
Cacerola alta

art.	Ø cm.	h.	lt.
16107-16	16	11,0	2,1
16107-20	20	13,0	4,0
16107-24	24	15,0	6,5
16107-28	28	17,5	10,8
16107-32	32	19,5	15,7
16107-36	36	21,0	21,5
16107-40	40	24,0	30,0
16107-45	45	27,0	43,0
16107-50	50	30,0	59,0



Casseruola bassa
Casserole pot
Bratentopf
Sautoir
Cacerola baja

art.	Ø cm.	h.	lt.
16109-24	24	9,5	4,3
16109-28	28	11,0	6,7
16109-32	32	12,5	10,0
16109-36	36	14,0	14,0
16109-40	40	16,0	20,0
16109-45	45	18,0	28,5
16109-50	50	19,0	37,0
16109-60	60	21,5	60,0



Colapasta per pentola
Colander for stock pot
Seiher für Suppentopf
Passoire pour marmite
Colador para olla recta

art.	Ø cm.	h.
16926-32	32	31
16926-36	36	37
16926-40	40	40



Couscoussiera
Couscous pan
Couscoustopf
Couscoussier
Cuscusera

art.	Ø cm.	h.	lt.
46970-18	36	22+17	18
46970-25	40	25+20	25



Casseruola a vapore con coperchio
Potato steamer pot with cover
Kartoffeldämpfer mit Deckel
Marmite à pommes-de-terre avec couvercle
Cuscusera con tapa

art.	Ø cm.	h.	lt.
16923-32	32	21+15	12
16923-36	36	23+17	18
16923-40	40	25+20	25



Casseruola ovale con coperchio
Oval saucepan with cover
Ovale Kasserolle mit Deckel
Casserole ovale avec couvercle
Cacerola oval con tapa

art.	Ø cm.	h.	lt.
16938-36	36	14,5	10
16938-40	40	16,0	14
16938-45	45	17,0	19



Casseruola alta
Saucepan
Stielkasserolle, hoch
Casserole haute
Cazo recto alto

art.	Ø cm.	h.	lt.
16106-16	16	11,0	2,1
16106-20	20	13,0	4,0
16106-24	24	15,0	6,5
16106-28	28	17,5	10,8



Casseruola bassa
Casserole pot
Stielkasserolle, niedrig
Sautoir
Cacerola baja

art.	Ø cm.	h.	lt.
16108-20	20	8,0	2,5
16108-24	24	9,5	4,3
16108-28	28	11,0	6,7



Padella
Frypan
Bratpfanne
Poêle à frire
Sarté

art.	Ø cm.	h.
16114-20	20	4,0
16114-24	24	5,0
16114-28	28	5,0
16114-32	32	5,3
16114-36	36	6,0
16114-40	40	7,0



Tegame
French omelet pan
Pfanne
Poêle à paella
Paellera

art.	Ø cm.	h.
16115-24	24	5,5
16115-28	28	6,0
16115-32	32	6,5
16115-36	36	7,0
16115-40	40	7,5
16115-45	45	7,5



Coperchio
Cover
Deckel
Couvercle
Tapa

art.	Ø cm.
16961-16	16
16961-20	20
16961-24	24
16961-28	28
16961-32	32
16961-36	36
16961-40	40
16961-45	45
16961-50	50
16961-60	60



Casseruola alta, antiaderente
Casserole pot, non stick
Fleischtopf nichttaftend
Brasière, anti-adhérente
Cacerola alta, antiadherente

art.	Ø cm.	h.	lt.
16127-16	16	11,0	2,1
16127-20	20	13,0	4,0
16127-24	24	15,0	6,5
16127-28	28	17,5	10,8
16127-32	32	19,5	15,7
16127-36	36	21,0	21,5
16127-40	40	24,0	30,0



Casseruola bassa, antiaderente
Casserole pot, non stick
Bratentopf nichttaftend
Sautoir, anti-adhérente
Cacerola baja, antiadherente

art.	Ø cm.	h.	lt.
16120-24	24	9,5	4,3
16120-28	28	11,0	6,7
16120-32	32	12,5	10,0
16120-36	36	14,0	14,0
16120-40	40	16,0	20,0



Tegame, antiaderente
French omelet pan, non stick
Pfanne, nichttaftend
Poêle à paella, anti-adhérente
Paellera antiadherente

art.	Ø cm.	h.
16116-28	28	6,5
16116-32	32	6,5
16116-36	36	7,0
16116-40	40	7,5



Padella, antiaderente
Frypan, non stick
Bratpfanne, nichttaftend
Poêle, anti-adhérente
Sartén antiadherente

art.	Ø cm.	h.
41720-18	18	3,8
41720-20	20	3,8
41720-24	24	4,5
41720-28	28	5,4
41720-30	30	5,4
41720-32	32	5,6



Padella, rivestimento in ceramica
Frypan, ceramic coating
Bratpfanne, keramische Beschichtung
Poêle, revêtement céramique
Sartén cobertura en ceramica

art.	Ø cm.	h.
11720-18	18	3,8
11720-20	20	3,8
11720-24	24	4,5
11720-28	28	5,4
11720-30	30	5,4
11720-32	32	5,6



Padella, antiaderente
Frypan, non stick
Bratpfanne, nichttaftend
Poêle, anti-adhérente
Sartén antiadherente

art.	Ø cm.	h.
16117-20	20	4,0
16117-24	24	5,0
16117-28	28	5,0
16117-32	32	5,3
16117-36	36	6,0
16117-40	40	7,0



Padella, antiaderente
Frypan, non stick
Bratpfanne, nichttaftend
Poêle, anti-adhérente
Sartén antiadherente

art.	Ø cm.	h.
16147-20	20	3,4
16147-24	24	4,2
16147-28	28	4,5
16147-32	32	5,5
16147-36	36	6,0
16147-40	40	6,0



Padella forgiata, rivestimento antiaderente
Forged frypan, non stick coating
Pfanne, geschmiedet, nichttaftend Beschichtung
Poêle forgée, revêtement anti-adhérente
Sartén forjada, cobertura antiadherente

art.	Ø cm.	h.
11617-20	20	3,4
11617-24	24	4,2
11617-28	28	4,5
11617-32	32	5,5
11617-36	36	6,0



Tegame forgiato, rivestimento ceramica
Forged omelet pan, ceramic coating
Pfanne, geschmiedet, keramische Beschichtung
Poêle forgée, revêtement céramique
Paellere forjada, cobertura ceramica

art.	Ø cm.	h.
11619-20	20	3,4
11619-24	24	4,2
11619-28	28	4,5
11619-32	32	5,5
11619-36	36	6,0



Padella forgiata, rivestimento ceramica
Forged frypan, ceramic coating
Pfanne, geschmiedet, keramische Beschichtung
Poêle forgée, revêtement céramique
Sartén forjada, cobertura ceramica

art.	Ø cm.	h.
11618-20	20	3,4
11618-24	24	4,2
11618-28	28	4,5
11618-32	32	5,5
11618-36	36	6,0



Padella bombata antiaderente, manico ferro
Frypan, non stick, cast iron handle
Bratpfanne, nichttaftend, Gusseisen-Stiel
Poêle bombé, anti-adhérente, queue fonte
Sartén antiadherente, mango hierro

art.	Ø cm.	h.
16113-20	20	5,5
16113-24	24	6,5
16113-28	28	7,0
16113-32	32	7,5
16113-36	36	8,0
16113-40	40	8,5



Padella antiaderente, manico ferro
Frypan, non stick, cast iron handle
Bratpfanne, nichttaftend, Gusseisen-Stiel
Poêle, anti-adhérente, queue fonte
Sartén antiadherente, mango hierro

art.	Ø cm.	h.
16717-20	20	4,0
16717-24	24	5,0
16717-28	28	5,0
16717-32	32	5,3
16717-36	36	6,0
16717-40	40	7,0



Padella crêpes, antiaderente
Crêpes pan, non stick
Crêpepfanne, nichttaftend
Poêle à crêpes, anti-adhérente
Sartén crêpes antiadherente

art.	Ø cm.
16118-24	24



Padella crêpes antiaderente
Crêpes pan, non-stick
Crêpes-Pfanne, nichttaftend
Tuile à crêpes anti-adhérente
Sartén para crêpes, antiadherente

art.	Ø cm.
16712-22	22
16712-26	26
16712-30	30



La crespella (in francese: crêpe) è una cialda sottile a base di latte, uova e farina. Farcita di ripieni vari, dolci o salati è generalmente considerata una pietanza tipica della cucina francese.

The pancake (in French: crêpe) is a type of thin wafer made from milk, eggs and flour. Usually stuffed with various fillings, sweet or salty and rolled up this pancake is generally considered as a typical French dish.



Padella per blinis, antiaderente
Non-stick blinis pan
Blinis-Pfännchen, nichttaftend
Poêle à blinis, anti-adhérente
Sartén blinis, antiadherente

art.	Ø cm.	h.
16719-12	12	2



Tegame
Bake roasting pan
Pfanne
Plat à four
Rustidera

art.	dim. cm.	h.
16941-40	40x26	7,5
16941-45	45x30	7,5
16941-50	50x30	8,0
16941-60	60x35	9,0
16941-61*	61x43	9,0

*Per forno GN 2/1. - For 2/1 GN ovens.



Tegame
Bake roasting pan
Pfanne
Plat à four
Rustidera

art.	dim. cm.	h.
16943-40	40x26	7,5
16943-45	45x30	7,5
16943-50	50x30	8,0
16943-60	60x35	9,0
16943-61*	61x43	9,0

*Per forno GN 2/1. - For 2/1 GN ovens.



Tegame, antiaderente
Bake roasting, non stick
Pfanne, nichthaftend
Plat à four, anti-adhérente
Rustidera antiaderente

art.	dim. cm.	h.
16947-40	40x26	7,5
16947-45	45x30	7,5
16947-50	50x30	8,0
16947-60	60x35	9,0
16947-61*	61x43	9,0

*Per forno GN 2/1. - For 2/1 GN ovens.



Tegame basso
Bake roasting pan
Pfanne, flach
Plat à four bas
Bandeja horno

art.	dim. cm.	h.
16944-45	45x30	4
16944-50	50x30	4
16944-60	60x35	4



Coperchio per tegami
Lid for roasting pans
Deckel für Bräter
Couvercle pour plaques à rôtir
Tapa para rustidera

art.	dim. cm.
16948-40	40x26
16948-45	45x30
16948-50	50x30
16948-60	60x35
16948-61	61x43



Brasiera con coperchio
Roasting pan with cover
Brazier mit Deckel
Braisière avec couvercle
Rustidera alta con tapa

art.	dim. cm.	h.	lt.
16965-40	40x26	15	14
16965-50	50x30	15	21
16965-60	60x35	15	30



Pesciera
Fish kettle
Fisch-Kochkessel
Poissonnière
Hervidor pescado

art.	dim. cm.	h.	lt.
16939-50	50x15	12	9
16939-60	60x17	13	13
16939-70	70x19	14	18
16939-80	80x24	17	30

Fornita completa di griglia e coperchio.
Equipped with grid and cover.



PA+
plus

Colapasta a spicchi 1/4, rete
1/4-Segment wire colander
1/4 Netzseiher-Einsatz
Passoire cuit-pâtes à gaze, 1/4
Colador red 1/4

art.	Ø cm.	h. cm.
12992-36	36	23
12992-40	40	26



Casseruola, alluminio
Sauce-pot, aluminum
Gemüsetopf, Aluminum
Braisière, alu
Cacerola, aluminio

art.	Ø cm.	h.	lt.
16929-36	36	17	17,0
16929-40	40	18	22,5

Fornita senza spicchi.
Supplied without colanders.



Bagnomaria
Bain-marie pot
Wasserbadkasserolle
Casserole bain-marie
Baño maria

art.	Ø cm.	h.	lt.
16910-14	14	16	2,5
16910-16	16	18	3,7
16910-18	18	20	5,0
16910-20	20	22	7,0



Colafritto, inox
Fry dripping tray, stainless steel
Pommes-Frites-Seiher, Edelstahl Rostfrei
Egouttoir à friture, inox
Escurridor para fritura, inox

art.	Ø cm.
41930-39	39

PADELLE FERRO STEEL FRYING PANS

**INDUCTION
READY!**



Il ferro è ottimo per le cotture a fuoco molto vivo perché, non avendo un'alta capacità di trasmettere calore, evita improvvisi sbalzi di temperatura. Essendo un materiale antiaderente, evita l'attaccamento dei cibi. Sopporta temperature elevatissime e col tempo migliora il suo rendimento. I recipienti in ferro sono i più adatti per frittiture, omelette o sottili crêpes. La padella in ferro nera va lavata con acqua il meno possibile e mantenuta sempre unta.

Il ferro è il materiale ideale anche per cotture a induzione.

Iron is ideal for cooking at high temperatures because its low capacity of heat transmission prevents temperature leaps. As it is non-stick, food does not stick to it. It withstands very high temperatures and improves its performance with use. Iron pans are perfect for fried food, omelettes or fine crêpes. Wash the black iron pan in water as little as possible and always keep it greased.

Iron pans are ideal also for cooking on induction hobs.



Padella lionese, pesante
Heavy blacksteel frypan
Schwere Eisenpfanne
Coupe lyonnaise extra-forte
Sartén honda pesada

art.	Ø cm.	h.
11714-20	20	3,8
11714-22	22	4,0
11714-24	24	4,5
11714-26	26	4,5
11714-28	28	4,5
11714-32	32	5,0
11714-36	36	5,5
11714-40	40	5,5
11714-45	45	5,5
11714-50	50	6,0



Padella lionese
Blacksteel frypan
Eisenpfanne
Coupe lyonnaise
Sartén honda

art.	Ø cm.	h.
11716-16	16	4,0
11716-20	20	4,5
11716-22	22	4,5
11716-24	24	5,0
11716-26	26	5,5
11716-28	28	5,5
11716-32	32	6,0
11716-36	36	6,5
11716-40	40	7,0
11716-45	45	8,0



Padella per paella
Blacksteel paella pan
Paella Eisenpfanne
Coupe lyonnaise à paella
Paellera

art.	Ø cm.	h.
11717-34	34	5,0
11717-37	37	5,5
11717-42	42	6,0
11717-47	47	6,5

PENTOLAME FERRO IRON COOKWARE



Padella per paella
Blacksteel paella pan
Paella Eisenpfanne
Coupe lyonnaise à paella
Paellera

art.	dim. cm.	h.
41717-60	60	6,5
41717-80	80	9,0



Padella ovale
Blacksteel fish pan
Fischeisenpfanne, oval
Coupe ovale
Sartén oval

art.	dim. cm.	h.
41719-32	32x23	5,0
41719-36	36x26	5,0
41719-40	40x28	5,5



Padella crêpes
Blacksteel crêpes pan
Crêpes Eisenpfanne
Coupe lyonnaise à crêpes
Sartén crêpes

art.	Ø cm.	h.
11718-20	20	2
11718-22	22	2
11718-24	24	2



Padella crêpes, alluminio antiaderente
Crêpes pan, aluminum, non-stick coated
Crêpes -Pfanne, Aluminum, nichttaftend
Poêle à crêpes, alu, anti-adhérente
Sartén crêpes, aluminio, antiaderente

art.	dim. cm.	h.
16971-36	36,5x22,5	3,5
16971-47	47x29	4,5



Padella per blini
Blinis pan
Blinis-Eisenpfännchen
Poêle à blinis
Sartén blinis

art.	Ø cm.	h.
11715-12	12	2



Padella ovale
Blacksteel fish pan
Fischeisenpfanne, oval
Coupe ovale
Sartén oval

art.	dim. cm.
41703-38	38x26



Wok
Wok pan
Wok-Pfanne
Poêle chinoise
Wok

art.	Ø cm.	h.
11713-32	32	10
11713-40	40	11



Padella per castagne
Chestnut pan
Kastanienpfanne
Poêle à marrons
Sartén para castañas

art.	Ø cm.
11721-28	28



Coprimanico silicone
Silicone sleeve
Silikon-Stielhülle
Revêtement manche en silicone
Cubre mango silicona

art.	Ø cm.	col.
11710-AA	20-36	●
11710-AB	40-50	●

Coprimanico in silicone ideale per tutte le padelle con manico in ferro. Garantisce una gradevole presa, resistente al calore fino a 230°C, non scalda e si toglie agevolmente per una facile pulizia.

The silicone cool touch sleeve slides onto cast iron fry pan handles for more secure food handling and slide off for easy cleaning. Heat resistant up to 230°C.

Adatto alle padelle art. - Suits fry pans items: 16717 - 16113 - 16712 - 11714 - 11716 - 11718 - 11713 - 11721.

PADERNO PADERNO



Totem per padelle
Frypan stand
Pfannenstand
Présentoir poêlles
Expositor

art.	h. cm.
XO1046	180



Padella per friggere
Fry pan
Frittier-Pfanne
Tuile à frire
Sartén freidora

art.	Ø cm.	h.	lt.
41707-32	32	9,8	6,0
41707-36	36	11,0	8,8
41707-40	40	13,4	12,2
41707-45	45	15,0	17,3
41707-50	50	17,6	23,5



Cestello per friggere, stagnato
Wire basket, tinned
Frittier-Rost, verzinkt
Grille à frire, étamée
Cesta escurrefrito, estañada

art.	Ø cm.	h.
41708-32	32	11,0
41708-36	36	11,5
41708-40	40	12,4
41708-45	45	15,5
41708-50	50	16,5

SERIE 15300 - 15400 P



Rame massiccio, spessore da 1,5 a 2,5 mm internamente stagnato a mano sulla fiamma. Manici e maniglie in ottone massiccio lucidato a specchio ed assemblati con rivetti di forte sezione. Adatto ad uso su tutti i fuochi (eccetto induzione).

Solid copper, thickness from 1,5 to 2,5 mm, the interiors are tinned over the fire by hand. Handles in highly polished solid brass, assembled with wide rivets. For use on any heating element (except on induction hob).



Pentola
Stock pot
Hoher Suppentopf
Marmite traiteur
Olla recta

art.	Ø cm.	h.	lt.
15301-22	22	20	8,0

PENTOLAME RAME COPPER COOKWARE



Casseruola bassa
Casserole pot
Bratentopf
Sautoir
Cacerola baja

art.	Ø cm.	h.	lt.
15309-26	26	9	5,0
15309-30	30	9	7,0



Coperchio
Cover
Deckel
Couvercle
Tapa

art.	Ø cm.
15361-22	22
15361-26	26
15361-30	30



Casseruola ovale
Oval saucepan
Ovaler Bratentopf
Casserole ovale
Cacerola oval

art.	dim. cm.	h.
15338-38	38x25	13



Tegame rettangolare
Bake roasting pan
Rechteckige Pfanne
Plat à four
Rustidera

art.	dim. cm.	h.
15343-36	38x28	11



Tegame ovale
Oval pan
Ovale Bratpfanne
Plat ovale à poignées
Bandeja oval

art.	dim. cm.	h.
15339-36	38x26	11



Pesciera
Fish kettle
Fischkochkessel
Poissonnière
Hervidor pescado

art.	dim. cm.	h.
15438-50	50x18	11



Tegame
Round pan
Runder Bräter
Plat rond
Paellera

art.	Ø cm.	h.
15315-26	26	4,5
15315-30	30	5,0
15315-36	36	6,0



Padella
Frypan
Bratpfanne
Poêle à frire
Sartén

art.	Ø cm.	h.
15314-22	22	4,0
15314-26	26	4,5
15314-30	30	5,0
15314-36	36	6,0



Paiolo
Sauté pan
Kasserolle
Sauteuse
Cazo cónico

art.	Ø cm.	h.
15412-25	25	13



Casseruola per zucchero
Sugar saucepan
Zuckerpfännchen
Poelon à sucre
Cacerola para azúcar

art.	Ø cm.	h.
15406-16	16	9
15406-20	20	10



Casseruola per zabaione
Zabaione bowl
Zabaionekasserolle
Poelon à zabaione
Cacerola sabayón

art.	Ø cm.
15407-16	16
15407-20	20



Base per casseruola zabaione
Foot for zabaione bowl
Fuss für Zabaionekasserolle
Base pour poelon à zabaione
Base para cacerola sabayón

art.	dim. cm.	h.
15401-51	8	4,5



N

Bastardella semisferica
Mixing bowl
Schneeschlagesessel
Bassine hémisphérique
Caldero

art.	Ø cm.
15409-26	26
15409-30	30
15409-36	36

Finitura smerigliata. - *Frosted finishing.*



N

Stampo scanalato
Bordelais moulds
Bordelais-Kuchenform
Moule à cannelés Bordelais
Molde para bordelais

art.	Ø cm.	h. cm.
15415-03	5,5	5

Set 3 pezzi. - 3 pcs set.



Bagnomaria
Bain-marie
Wasserbadkasserolle
Bain-marie
Baño maría

art.	Ø cm.	h.
15403-12	12	14,5
15403-16	16	17,0

Con porcellana. - *With porcelain.*



Set fonduta
Fondue set
Fondue-Service
Service à fondue
Servicio para fondues

art.	Ø cm.	h.
15430-11	16	26

Coperchio incluso. - *Lid included.*



Casseruolina
Small saucepan
Kleine Stielkasserolle
Casserolette
Cacerola pequeña

art.	Ø cm.	h.
15309-07	7	3



Casseruolina
Small saucepan
Kleine Stielkasserolle
Casserolette
Cacerola pequeña

art.	Ø cm.	h.
15306-07	7	4



Casseruolina
Small saucepan
Kleine Stielkasserolle
Casserolette
Cacerola pequeña

art.	Ø cm.	h.
15306-10	10	5

Coperchio incluso. - *Lid included.*



Scaldaburro
Butter warmer
Butter-Rechaud
Réchaud à beurre
Hornillo con cacerola

art.	Ø cm.	h.
15404-10	10	6

Con porcellana. - *With porcelain.*

SERIE 15200



Rame 3-ply spessore mm 2,2. Materiale multistrato (rame massiccio finitura lucida con sottile stato intermedio in alluminio e lamina interna in inox 18/10). Una combinazione che assicura una distribuzione rapida ed uniforme del calore su tutta la superficie dell'utensile. Manici e maniglie sono in ottone massiccio lucidato ed assemblati con rivetti di forte sezione. Adatto ad uso su tutti i fuochi (eccetto induzione).

Copper Serie 15200, 3-ply thickness 2,2 mm. Features super heat-conductive multi-layer construction (polished solid copper, intermediate aluminum layer and 18-10 stainless steel inner sheet). A material combination that distributes heat from bottom to rim quickly and evenly. Handles in polished solid brass, assembled with wide rivets. For use on any heating element (except on induction hob).



Coperchio
Cover
Deckel
Couvercle
Tapa



art.	Ø cm.	art.	Ø cm.
15261-16	16	15261-26	26
15261-20	20	15261-30	30
15261-24	24		



Casseruola alta
Saucepot
Fleischtopf
Brasière
Cacerola alta

art.	Ø cm.	h.	lt.
15207-16	16	8	1,5
15207-20	20	11	3,5
15207-26	26	14	8,0



Casseruola bassa
Casserole pot
Bratentopf
Sautoir
Cacerola baja

art.	Ø cm.	h.	lt.
15209-24	24	9,0	4,0
15209-26	26	9,0	5,0
15209-30	30	9,5	7,0



Casseruola alta
Saucepan
Stielkasserolle, hoch
Casserole haute
Cazo recto alto

art.	Ø cm.	h.	lt.
15206-16	16	8	1,5
15206-20	20	11	3,5



Casseruola bassa
Casserole pot
Stielkasserolle, niedrig
Sautoir
Cacerola baja

art.	Ø cm.	h.	lt.
15208-24	24	9	4,0
15208-26*	26	9	5,0



Padella
Frypan
Bratpfanne
Poêle à frire
Sartén

art.	Ø cm.	h.
15214-26	26	5



Tegame
Round pan
Runder Bräter
Plat rond
Paellera

art.	Ø cm.	h.
15215-26	26	5

* Con contromaniglia. - With loop handle.

MINIATURE MINI OVENS



Una gamma di miniature ideali per contorni e singole porzioni, soufflé, pasta al forno, creme di riso, raclette, brioche salate e dolci, desserts, ecc., ecc.. Polivalenti, funzionali, pronte per essere servite dalla cucina alla tavola. Originali eppure tradizionali, provengono dal mondo dell'alta gastronomia, strumento ideale per valorizzare creazioni estrose o le più semplici ricette, per amore della convivialità, per donare un aspetto più ludico ai nostri pasti.

A range of small pots ideal for side dishes and individual servings, soufflés, baked pasta, rice creams, raclette, savory as well as sweet pastries, desserts, etc., etc.. Versatile, functional, ready to be served from the kitchen to the table. Original and yet traditional, they come from the world of haute cuisine, ideal for enhancing creations or the most simple recipes, for the sake of conviviality, to give a more playful aspect to our meals.

PENTOLAME MINIATURE MINI OVENS COOKWARE



Casseruola alta
Saucepan
Stielkasserole, hoch
Casserole haute
Cazo recto alto

art.	Ø cm.	h.
16136-10	10	6



Casseruola bassa
Sauté pan
Stielkasserole, niedrig
Plat à sauter
Cazo recto bajo

art.	Ø cm.	h.
16138-10	10	4



Padella
Frypan
Bratpfanne
Poêle à frirer
Sartén

art.	Ø cm.	h.
16134-12	12	4



Casseruola alta
Saucepan
Fleischtopf
Casserole haute
Cazo recto alto

art.	Ø cm.	h.
16137-10	10	6



Casseruola bassa
Casserole pot
Bratentopf
Sautoir
Cacerola baja

art.	Ø cm.	h.
16139-10	10	4



Tegamino
French omelet pan
Pfanne
Poêle à paella
Paellera

art.	Ø cm.	h.
16135-12	12	4

Corpo in alluminio con rivestimento antiaderente, manicatura in ottone. - Aluminum body non-stick coated, brass handles.



Padella blini, alluminio antiaderente
Blinis non-stick aluminum pan
Blinis-Alupfännchen, nichtaftend
Poêle à blinis, alu anti-adhérente
Sartén blinis, antiadherente

art.	Ø cm.	h.
16719-12	12	2



Padella blini, ferro
Blinis steel frypan
Blinis-Eisenpfännchen
Poêle à blinis, acier
Sartén blinis, hierro

art.	Ø cm.	h.
11715-12	12	2



Casseruola con coperchio, 3-ply
Saucepot with lid
Fleischtopf mit Deckel
Brasière avec couvercle
Cacerola alta con tapa

art.	Ø cm.	h.	lt.
12509-12	12	6	0,7



Casseruola con due becchi, 3-ply
Sauté pan with double spouts
Stielkasserolle, niedrig, 2 Schnabel
Plat à sauter, 2 becs
Cazo recto bajo, 2 picos

art.	Ø cm.	h.	lt.
12511-10	10	5,0	0,4



Casseruola bassa, 3-ply
Sauté pan
Stielkasserolle, niedrig
Plat à sauter
Cazo recto bajo

art.	Ø cm.	h.	lt.
12511-12	12	6	0,7



Casseruola bassa, 3-ply
Sauté pan
Stielkasserolle, niedrig
Plat à sauter
Cazo recto bajo

art.	Ø cm.	h.	lt.
12511-14	14	7	1,0

GHISA SMALTATA ENAMELLED CAST IRON

INDUCTION
READY!



SLOW COOKING - FAST GRILLING - COOK & SERVE



Idonee all'uso su tutte le fonti di cottura (gas, elettriche, vetroceramica, induzione) e forni (gas, petrolio, carbone o legna) ad esclusione di microonde. Una perfetta armonia tra ghisa, smalto e alta qualità. Progettate e costruite per assorbire e diffondere il calore in modo uniforme. La ghisa è adatta a tutte le tecniche di cottura, per zuppe, arrosti, risotti, dolci, per piatti che richiedono una lunga cottura tipo brasati e allo stesso modo ideale per carni e verdure alla griglia in quanto ne esalta sapori ed aromi in stile barbecue. La ghisa ha anche caratteristiche di antiaderenza. La temperatura elevata della padella cauterizza la superficie della carne. Tutto il sapore, l'acqua e i valori nutrizionali rimangono sigillati nel cibo. Nella cottura in casseruole, il vapore generato grazie al particolare design del coperchio si condensa ricadendo e mescolandosi nuovamente nel cibo non solo trattenendo sapori e aromi ma fornendo la miglior protezione alle sostanze nutrienti e contribuendo ad una dieta sana. La ghisa è un materiale riciclabile al 100% e quindi ecologico. Inoltre, grazie alla sua capacità di mantenere il calore per lungo tempo consente un notevole risparmio di energia permettendo di cuocere a fuoco basso. Anche a tavola mantengono in cibi in temperatura. La ghisa mantiene però il caldo come pure il freddo... può essere usata per mantenere il cibo fresco. Riposta per un breve periodo in frigorifero, mantiene il cibo fresco nelle calde giornate estive e ideale per servire insalate di pasta, riso, farro, ecc., ecc. Pratica e facile da pulire. Queste casseruole e padelle in ghisa sono lavabili in lavastoviglie, per merito della speciale tecnologia applicata al metodo di smaltatura. Manicatura e pomoli dal design ergonomico sono in ghisa e inox. Durante la cottura si raccomanda di maneggiare con un panno consistente e asciutto per evitare di scottarsi.

Suitable for use on all cooking hobs (gas, electric, ceramic, induction) and ovens (gas, oil, coal or wood) except microwave. A perfect harmony of cast iron, enamel and high quality. Designed and constructed to absorb and spread the heat evenly. Cast iron is suitable for all cooking techniques, for soups, roasts, rice, desserts, for braise that require a long cooking and likewise ideal for meats and grilled vegetables as it enhances flavors and aromas like barbecue style. Cast iron also features non-stick. The high temperature of the pan sears the meat surface. All the flavor, water and nutritional values remain sealed in the food. When cooking in casseroles, the steam generated thanks to the special design of the cover condenses falling back into the food not only retaining flavors and aromas but providing the best protection for nutrients and contributing to a healthy diet. Cast iron is a material 100% recyclable and therefore environmentally friendly. Moreover, thanks to its ability to retain heat for a long time it allows a considerable saving of energy. With closed lid on the table, the pot will preserve the temperature for a second serving. Cast iron retains the heat but as well the cold... can be used to keep the food fresh. Stored for a short time in the refrigerator, keeps food cool during hot summer days, ideal for serving pasta or rice salads, etc. Practical and easy to clean. These cast iron pots and pans are dishwasher safe thanks to the special technology applied to their enameling method. Ergonomic knobs and handles made of cast iron and stainless steel, suitable for use on all heat sources and ovens except microwave. Be careful, they heat up during cooking, it is recommended to handle with a dry thick cloth.



Casseruola tonda
Saucepot round
Fleischtopf, rund
Brasière
Cacerola redonda

art.	ø cm.	lt.	col.
44201R10	10	0,35	●
44201V10	10	0,35	●
44201B10	10	0,35	●
44201O10	10	0,35	●
44201N10	10	0,35	●
44201Y10	10	0,35	●
44201W10	10	0,35	○

Porzioni/Portion: 1 - Kg. 1,15.

Casseruola tonda
Saucepot round
Fleischtopf, rund
Brasière
Cacerola redonda

art.	ø cm.	lt.	col.
44201R12	12	0,55	●
44201V12	12	0,55	●
44201B12	12	0,55	●
44201O12	12	0,55	●
44201N12	12	0,55	●
44201Y12	12	0,55	●
44201W12	12	0,55	○

Porzioni/Portion: 1 - Kg. 1,54.



Casseruola ovale
Oval saucepan
Ovaler Bratentopf
Casserole ovale
Cacerola oval

art.	dim. cm.	h.	lt.	col.
44202R12	12x9	6	0,42	●
44202V12	12x9	6	0,42	●
44202B12	12x9	6	0,42	●
44202O12	12x9	6	0,42	●
44202N12	12x9	6	0,42	●
44202Y12	12x9	6	0,42	●
44202W12	12x9	6	0,42	○

Porzioni/Portion: 1 - Kg. 1,45.

Supporto legno
Wooden Stand
Holz-Träger
Support en bois
Soporte de madera

art.	ø cm.
44201-03	10



Supporto legno
Wooden Stand
Holz-Träger
Support en bois
Soporte de madera

art.	ø cm.
44201-01	10



Piatto legno
Wooden platter
Holzbrett
Planche en bois
Tabla de madera

art.	ø cm.
44201-10	10-12

Piatto legno
Wooden platter
Holzbrett
Planche en bois
Tabla de madera

art.	dim. cm.
44202-10	12x9

Coppa soufflé con piatto legno
Soufflé pot with wooden platter
Ramekin mit Holzbrett
Ramequin avec planche bois
Fuente soufflé con tabla madera

art.	ø cm.	lt.
44240S08	8	0,17

Porzioni/Portion: 1 - Kg. 0,57.



Casseruola alta
Saucepot
Fleischtopf
Brasière
Cacerola alta

art.	ø cm.	lt.	por.	kg.	col.
44201R16	16	1,0	1-2	2,64	●
44201N16	16	1,0	1-2	2,64	●
44201R20	20	2,6	2-3	4,34	●
44201N20	20	2,6	2-3	4,34	●
44201R24	24	4,5	4-5	5,76	●
44201N24	24	4,5	4-5	5,76	●
44201R28	28	6,7	6-8	7,79	●
44201N28	28	6,7	6-8	7,79	●
44201R32	32	10,0	12-16	9,61	●
44201N32	32	10,0	12-16	9,61	●



Casseruola alta coperchio vetro
Saucepot with glass lid
Fleischtopf mit Glasdeckel
Brasière avec couvercle verre
Cacerola alta con tapa vidrio

art.	ø cm.	lt.	por.	kg.	col.
44203R20	20	2,6	2-3	4,65	●
44203R24	24	4,5	4-5	4,95	●
44203R28	28	6,7	6-8	6,14	●



Casseruola ovale
Oval saucepan
Ovaler Bratentopf
Casserole ovale
Cacerola oval

art.	ø cm.	lt.	por.	kg.	col.
44202R25	25	3,3	4	5,44	●
44202N25	25	3,3	4	5,44	●
44202R27	27	4,0	4-6	5,88	●
44202N27	27	4,0	4-6	5,88	●
44202R29	29	4,8	6	6,78	●
44202N29	29	4,8	6	6,78	●



Casseruola bassa coperchio vetro
Casserole pot with glass lid
Bratentopf mit Glasdeckel
Sautoir avec couvercle verre
Cacerola baja con tapa vidrio

art.	ø cm.	lt.	por.	kg.	col.
44204R24	24	2,4	4	3,81	●
44204R28	28	3,4	4-6	5,08	●



Casseruola alta con coperchio vetro
Saucepan with glass lid
Stielkasserolle, hoch mit Glasdeckel
Casserole haute avec couvercle verre
Cazo recto alto con tapa vidrio

art.	ø cm.	lt.	por.	kg.	col.
44239R16	16	1	1-2	2,64	●



Padella
Frypan
Bratpfanne
Poêle
Sartén

art.	ø cm.	lt.	por.	kg.
44205-16	16	0,42	1	1,41
44205-20	20	0,80	1-2	1,97



Padella manico legno
Frypan wooden handle
Bratpfanne mit Holz-Griff
Poêle manche bois
Sartén mango madera

art.	ø cm.	lt.	por.	kg.	col.
44205-24	24	1,5	4	2,65	●
44205-28	28	2,5	4-6	3,69	●



Padella grill manico inox
Grill pan stainless steel handle
Grill-Pfanne mit Edelstahl-Griff
Poêle grill manche inox
Sartén grill mango inox

art.	ø cm.	lt.	por.	kg.
44211-22	22	0,8	1-2	1,40
44211-26	26	1,0	4	1,95
44211-30	30	1,2	4-6	2,55



Sottopentola legno, magnetico
Wooden platter with magnetic feature
Holzbrett, magnetisch
Planche en bois, magnétique
Tabla madera magnética

art.	ø cm.
44207-16	16
44207-20	20
44207-24	24
44207-28	28

GHISA SMALTATA ENAMELLED CAST IRON



Coprimaniglie silicone
Silicone sleeves
Silikon-Griffhüllen
Revêtement en silicone pour poignées
Cubre asas de silicona

art.	col.
44208G00	grigio/grey
44208R00	rosso/red



Padella grill
Grill pan
Grill-Pfanne
Poêle grill
Sartén grill

art.	dim. cm.	lt.	por.	kg.	col.
44209R26	26x26	2,2	4	3,63	●
44209R32	26x32	2,6	6	4,28	●



Padella grill
Grill pan
Grill-Pfanne
Poêle grill
Sartén grill

art.	dim. cm.	lt.	por.	kg.
44210-26	26x26	2,2	4	3,79
44210-32	26x32	2,75	6	4,50



Padella grill con supporto a servire legno
Grill pan with wooden service stand
Grill-Pfanne mit Service-Holzbrett
Poêle grill avec support à servir bois
Sartén grill con tabla madera

art.	dim. cm.	lt.	por.	kg.
44210S26	26x26	2,20	4	4,37
44210S32	26x32	2,75	6	5,17



Padella grill
Grill pan
Grill-Pfanne
Poêle grill
Sartén grill

art.	dim. cm.	lt.	por.	kg.
44210-42	31x42	4,5	8	5,46



Padella grill con supporto a servire legno
Grill pan with wooden service stand
Grill-Pfanne mit Service-Holzbrett
Poêle grill avec support à servir bois
Sartén grill con tabla madera

art.	dim. cm.	lt.	por.	kg.
44210S42	31x42	4,5	8	5,94



Padella grill quadra con supporto legno
Grill pan square and wooden platter
Grill-Pfanne, viereckig mit Holzbrett
Poêle grill carrée avec plache bois
Sartén grill cuadrada con tabla madera

art.	dim. cm.	por.	kg.
44215S16	16x16	1	1,64



Padella grill con supporto a servire legno
Grill pan and wooden service stand
Grill-Pfanne mit Service-Holzbrett
Poêle grill carrée avec plache à servir bois
Sartén grill cuadrada con tabla madera

art.	dim. cm.	por.	kg.
44216S16	16x16	1	2,15

Ciotoline non include. - Cups not included.



Griglia reversibile
Griddle plate, dual side, reversible
Grill-Platte, zweiseitig, reversible
Gril rectangle, reversible
Parrilla reversible

art.	dim. cm.	por.	kg.
44217-45	26x47	6-8	5,87



Padella grill
Grill pan
Grill-Pfanne
Poêle grill
Sartén grill

art.	ø cm.	lt.	por.	kg.
44212-30	30	2,35	4-6	3,63



Bistecchiera
Grill pan
Grill-Pfanne
Poêle grill
Sartén grill

art.	dim. cm.	por.	kg.
44213-24	24x24	1-2	1,80
44213-36	21x36	2,4	2,36



Bistecchiera
Grill pan
Grill-Pfanne
Poêle grill
Sartén grill

art.	ø cm.	por.	kg.
44214-25	25	2-3	1,65



Tegame rettangolare
Bake roasting dish
Pfanne, rechteckig
Plat rectangulaire
Rustidera

art.	dim. cm.	por.	kg.	col.
44218R30	22x30	6-8	3,1	●
44218R40	26x40	8-12	5,0	●



Terrina
Terrine pot
Pasteten-Pfanne
Terrine rectangle
Fuente rectangular

art.	dim. cm.	h.	por.	kg.	col.
44219R26	8,5x26,5	6	2-4	2,85	●



Piatto pesce con supporto legno
Fish plate with wooden platter
Fischplatte mit Holzbrett
Plat à poisson avec planche bois
Bandeja pescado con tabla madera

art.	dim. cm.	por.	kg.
44220S24	15x24	1-2	1,81



Piatto pesce con supporto legno
Fish plate with wooden platter
Fischplatte mit Holzbrett
Plat à poisson avec planche bois
Fuente pescado con tabla madera

art.	dim. cm.	por.	kg.
44221S30	15,5x29,5	1-2	1,98



Piatto pizza
Pizza pan
Pizza-Platte
Plat à pizza
Fuente para pizza

art.	ø cm.	por.	kg.
44222-20	20	1	1,99
44222-28	28	1	3,35



Piatto pizza con supporto legno
Pizza pan with wooden platter
Pizza-Platte mit Holzbrett
Plat à pizza avec planche bois
Fuente para pizza con tabla madera

art.	ø cm.	por.	kg.
44222S20	20	1	1,99
44222S28	28	1	3,35

GHISA SMALTATA ENAMELLED CAST IRON



Griglia reversibile
Griddle plate, dual side, reversible
Grill-Platte, zweiseitig, reversible
Gril rectangle, reversible
Parrilla reversible

art.	dim. cm.	por.	kg.
44224-22	22x15	1-2	2,24



Griglia reversibile con tagliere a servire legno
Grill plate and wooden service platter
Grill-Platte mit Service-Holzbrett
Gril avec plache à servir bois
Grill con tabla madera

art.	dim. cm.	por.	kg.
44224S22	22x15	1-2	3,54



Barbecue da tavola
Hot plate and wooden service platter
Grill-Platte mit Service-Holzbrett
Gril avec plache à servir bois
Grill con tabla madera

art.	dim. cm.	por.	kg.
44225-22	22x15	1-2	4,44

Ciotoline non include. - Cups not included.

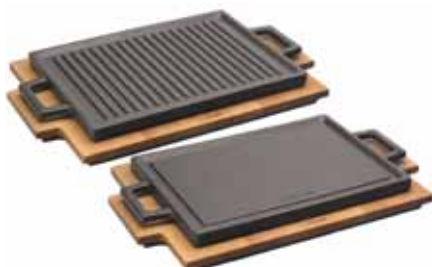

Griglia con supporto legno
Griddle with wooden platter
Grill-Platte mit Holzbrett
Gril rectangle avec planche bois
Grill con tabla madera

art.	dim. cm.	por.	kg.
44226S30	22x30	2-3	5,7



Barbecue da tavola
Hot plate and wooden service platter
Grill-Platte mit Service-Holzbrett
Gril avec plache à servir bois
Grill con tabla madera

art.	dim. cm.	por.	kg.
44227-30	22x30	2-3	5,94



Piatto fajita con supporto legno
Fajita plate with wooden platter
Fajitaplatte mit Holzbrett
Plat à fajitas avec planche bois
Fuente fajitas con tabla madera

art.	dim. cm.	por.	kg.
44228S23	17x23	1	2,04





Piatto fajita con supporto legno
Fajita plate with wooden platter
Fajitaplatte mit Holzbrett
Plat à fajitas avec planche bois
Fuente fajitas con tabla madera

art.	dim. cm.	por.	kg.
44229S20	10x20	1	1,67

Ciotoline non incluse. - *Cups not included.*



Piatto ovale con supporto legno
Oval plate with wooden platter
Ovalplatte mit Holzbrett
Plat oval avec planche bois
Fuente ovale con tabla madera

art.	dim. cm.	h.	por.	kg.
44230S10	15x10	2,5	1	0,99
44230S14	21x14	2,5	1-2	1,58



Piatto ovale con supporto legno
Oval plate with wooden platter
Platte mit Holzbrett, oval
Plat oval avec planche bois
Fuente ovale con tabla madera

art.	dim. cm.	h.	por.	kg.
44231-14	21x14	2,5	1-2	2

Ciotoline non incluse. - *Cups not included.*



Piatto tondo con supporto legno
Round plate with wooden platter
Platte mit Holzbrett, rund
Plat rond avec planche bois
Fuente redonda con tabla madera

art.	ø cm.	por.	kg.
44232S12	12	1	0,98
44232S16	16	1-2	1,39
44232S20	20	2-3	2,03



Piatto tondo con supporto legno
Round plate with wooden platter
Platte mit Holzbrett, rund
Plat rond avec planche bois
Fuente redonda con tabla madera

art.	ø cm.	lt.	por.	kg.
44233-16	16	0,46	1-2	1,74
44233-20	20	0,74	3-4	2,43

Ciotoline non incluse. - *Cups not included.*



Padella tonda
Round pan
Pfanne, rund
Poêle ronde
Sartén grill redonda

art.	ø cm.	por.	kg.
44234-12	12	1	0,91
44234-16	16	1-2	1,27

GHISA SMALTATA ENAMELLED CAST IRON



Padella tonda con supporto legno
Round pan and wooden platter
Pfanne, rund mit Holzbrett
Poêle ronde avec planche bois
Sartén grill redonda con tabla madera

art.	ø cm.	lt.	por.	kg.
44234S12	12	0,24	1	0,91
44234S16	16	0,45	1-2	1,27



Padella tonda con supporto legno
Round pan and wooden platter
Pfanne, rund mit Holzbrett
Poêle ronde avec planche bois
Sartén grill redonda con tabla madera

art.	ø cm.	lt.	por.	kg.
44235-16	16	0,45	1-2	1,92

Ciotoline non incluse. - *Cups not included.*



Tegame con supporto a servire legno
Rectangular pan with wooden service stand
Pfanne mit Service-Holzbrett
Poêle avec support à servir bois
Sartén con tabla madera

art.	dim. cm.	por.	kg.
44237S15	12x15	1-2	1,29



Tegame con supporto a servire legno
Rectangular pan with wooden service stand
Pfanne mit Service-Holzbrett
Poêle avec support à servir bois
Sartén con tabla madera

art.	dim. cm.	por.	kg.
44238-15	12x15	1-2	1,59

Ciotoline non incluse. - *Cups not included.*



Ciotola tortillas, legno
Tortillas cup, wood
Tortillas-Schale, Holz
Coupe-tortillas, bois
Copa tortillas, madera

art.	ø cm.
44241-19	19



Coppa soufflè
Soufflé pot
Ramekin
Ramequin
Fuente soufflè

art.	ø cm.	lt.
44240-08	8	0,17



Coppa salsa, porcellana
Sauce bowl, porcelain
Saucentasse, Porzellan
Bol à sauce, porcelaine
Copa para salsa, porcelana

art.
44242-00



Coppa salsa melamina
Sauce bowl, melamine
Saucentasse, Melamin
Bol à sauce, melamine
Copa para salsa, melamine

art.
44243-00



N

Piatto con supporto legno
Oval plate with wooden platter
Ovalplatte mit Holzbrett
Plat oval avec planche bois
Fuente ovale con tabla madera

art.	dim. cm.
44223S19	12,5x19



N

Griglia reversibile con supporto legno
Griddle plate, reversible with wooden platter
Grill-Platte, reversible mit Holzbrett
Gril reversible avec planche bois
Plancha grill reversible con tabla madera

art.	ø cm.	por.	kg.
44236S28	28	4	5,0
44236S34	34	6	6,5



N

Piatto servire con supporto legno
Service dish with wooden stand
Servierplatte mit Holzbrett
Plat à servir avec support en bois
Plato para servir con tabla madera

art.	dim. cm.	por.	kg.
44245S32	32x20	1-2	2,24



N

Piatto servire con supporto legno
Service dish with wooden stand
Servierplatte mit Holzbrett
Plat à servir avec support en bois
Plato para servir con tabla madera

art.	dim. cm.	por.	kg.
44244S30	30x15	1-2	2,36
44244S36	36x24	4-6	4,53



N

Casseruola con supporto legno
Hot pot with wooden stand
Schüssel mit Holzbrett
Bol avec support en bois
Bol con tabla madera

art.	ø cm.	h. cm.	lt.	por.	kg.
44246S11	11	4	0,21	1	0,65
44246S14	14	4	0,32	1	1,00
44246S17	17	4	0,59	1	1,46



N

Piatto servire con superficie porcellanata
Service dish with porcelain surface
Servierplatte mit Porzellan-Oberfläche
Plat à servir avec surface en porcelaine
Plato para servir con superficie porcelana

art.	dim. cm.	h. cm.	por.	kg.
44248S60	60x15	2,5	4	1,62



N

Piatto servire con superficie porcellanata
Service dish with porcelain surface
Servierplatte mit Porzellan-Oberfläche
Plat à servir avec surface en porcelaine
Plato para servir con superficie porcelana

art.	dim. cm.	h. cm.	por.	kg.
44249S30	20x30	2,5	1-2	1,26
44249S35	25x35	2,5	1-2	1,71



N

Piatto servire con superficie porcellanata
Service dish with porcelain surface
Servierplatte mit Porzellan-Oberfläche
Plat à servir avec surface en porcelaine
Plato para servir con superficie porcelana

art.	ø cm.	por.	kg.
44250S30	30	1-2	0,93
44250S35	35	1-2	1,46

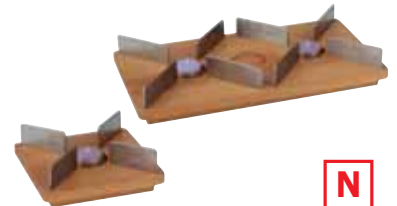

N

Rechaud, faggio/inox
Plate warmer, beechwood & stainless steel
Rechaud, Buche u. Edelstahl
Réchaud, hêtre/inox
Réchaud, madera/innox

art.	dim. cm.	h. cm.	kg.
44251-01	16x16	2,5	0,66
44251-03	36x20	2,5	1,84



N

Piatto servire con superficie porcellanata
Service dish with porcelain surface
Servierplatte mit Porzellan-Oberfläche
Plat à servir avec surface en porcelaine
Plato para servir con superficie porcelana

art.	dim. cm.	h. cm.	por.	kg.
44255-10	39,5x25	2,5	1	3,02

Fornito con mini casseruola ø 10 cm con coperchio. 2 coppette salsa escluse.
Incl. mini casserole ø10 cm. with lid. 2 sauce cups not included.



N

Piatto servire con superficie porcellanata
Service dish with porcelain surface
Servierplatte mit Porzellan-Oberfläche
Plat à servir avec surface en porcelaine
Plato para servir con superficie porcelana

art.	dim. cm.	h. cm.	por.	kg.
44255-12	39,5x25	2,5	1	3,32

Fornito con mini casseruola ovale 12 cm con coperchio. 2 coppette salsa escluse.
Incl. mini oval casserole 12 cm. with lid. 2 sauce cups not included.



N

Piatto servire con superficie porcellanata
Service dish with porcelain surface
Servierplatte mit Porzellan-Oberfläche
Plat à servir avec surface en porcelaine
Plato para servir con superficie porcelana

art.	dim. cm.	h. cm.	por.	kg.
44255-14	39,5x25	2,5	1	2,48
44255-16	39,5x25	2,5	1-2	2,66

Fornito con padella ø 12 cm. o ø 16 cm. 2 coppette salsa escluse. - Incl. mini skillet ø 12 cm. or ø 16 cm. 2 sauce cups not included.



N

Piatto servire con superficie porcellanata
Service dish with porcelain surface
Servierplatte mit Porzellan-Oberfläche
Plat à servir avec surface en porcelaine
Plato para servir con superficie porcelana

art.	dim. cm.	h. cm.	por.	kg.
44255-15	39,5x25	2,5	1-2	2,70

Fornito con tegamino 12x15 cm. 2 coppette salsa escluse. - Incl. mini dish 12x15 cm. 2 sauce cups not included.



N

Piatto servire con superficie porcellanata
Service dish with porcelain surface
Servierplatte mit Porzellan-Oberfläche
Plat à servir avec surface en porcelaine
Plato para servir con superficie porcelana

art.	dim. cm.	h. cm.	por.	kg.
44255-21	39,5x25	2,5	1-2	2,78

Fornito con tegamino 21x14 cm. 2 coppette salsa escluse. - Incl. mini dish 21x14 cm. 2 sauce cups not included.



N

Piatto servire con superficie porcellanata
Service dish with porcelain surface
Servierplatte mit Porzellan-Oberfläche
Plat à servir avec surface en porcelaine
Plato para servir con superficie porcelana

art.	dim. cm.	h. cm.	por.	kg.
44255-22	39,5x25	2,5	1-2	3,20

Fornito con tegamino ø 16 cm. 2 coppette salsa escluse. - Incl. mini pan ø16 cm. 2 sauce cups not included.

PIROFILE FORNO OVEN COOKING DISHES

Porcellana utilizzabile in forni tradizionali e microonde,
non mettere le porcellane a diretto contatto con la fiamma

Only use in the oven or microwave oven, do not place them on direct flame





Ovale cordonata
Oval dish, fluted
Schale, oval, gerippt
Plat ovale, cannelé
Fuente oval borderizata

art.	dim. cm.	h.
44371-24	24x14	4,0
44371-28	28x16	4,5
44371-32	32,5x18	5,0
44371-36	36,5x19,5	5,0
44371-40	41x23	5,5
44371-44	44x26,5	5,7
44371-48	48x28,5	6,5



Rotonda cordonata
Round dish, fluted
Schale, rund, gerippt
Plat rond, cannelé
Fuente redonda borderizata

art.	Ø cm.	h.
44372-26	26,5	2,5
44372-32	32,0	4,0
44372-36	36,0	4,0
44372-40	40,0	4,0



Rettangolare cordonata
Rectangular dish, fluted
Schale, rechteckig, gerippt
Plat rectangulaire, cannelé
Fuente rectangular borderizata

art.	dim. cm.	h.
44374-22	22x16	6
44374-25	25x20	7
44374-32	32x22	6
44374-36	36x24	6
44374-40	40x26	6
44374-44	44x32	6



Ovale cordonata, alta
Oval dish, high, fluted
Schale, oval, gerippt
Plat oval, cannelé
Fuente oval borderizata, alta

art.	dim. cm.	h.
44389-32	32x22	8,5



Rettangolare cordonata, bassa
Rectangular dish, low, fluted
Schale, rechteckig, flach, gerippt
Plat rectangulaire, cannelé
Fuente rect. borderizata, baja

art.	dim. cm.	h.
44376-40	40x30	4



Quadra cordonata
Square dish, fluted
Schale, quadratisch, gerippt
Plat carré, cannelé
Fuente cuadrada borderizata

art.	dim. cm.	h.
44375-25	25x25	6



Tegamino cordonato
Egg dish, fluted
Schale, gerippt
Plat à oeufs, cannelé
Fuente huevo borderizata

art.	dim. cm.
44394-18	18x21,0
44394-21	21x24,5



Coppetta creme broulée
Creme broulée bowl
Crème broulée Schale
Coupelle broulée à crème
Bol creme broulée

art.	Ø cm.	h.
44391-12	11,6	3



Tegamino fondo, cordonato
Egg dish, high, fluted
Schale, tief, gerippt
Plat oeuf, creux, cannelé
Fuente huevo borderizata, alta

art.	dim. cm.
44395-18	18x20

I soufflé, piatto tipico della cucina francese, sono delle preparazioni, dolci o salate, cotte al forno e composte da un impasto di burro, farina, latte e tuorli d'uovo, il tutto unito ad albumi montati a neve. La preparazione dei soufflé non è complessa, la fase più critica per la buona riuscita della ricetta è la cottura: i soufflé devono risultare soffici e belli gonfi.

Soufflé is a typical French dish. It can be sweet or savory, the basic mixture is made of butter, flour, milk and eggs. Soufflé recipes are actually quite easy and simple to prepare. The most critical part for the success of the recipe is cooking. The soufflé should be soft and beautifully puffed.



Casseroles con coperchio
Soup bowl with cover
Kasserolle mit Deckel
Casserole avec couvercle
Cacerola con tapa

art.	dim. cm.	lt.
44397-18	14x18	0,5



Soufflé cordonato
Ramekin, fluted
Ramekin, gerippt
Ramequin, cannelé
Fuente soufflé borderizata

art.	Ø cm.	h.
44390-07	7	4,0
44390-09	9	4,5
44390-11	11	6,0















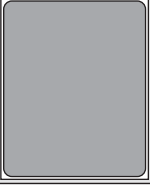

Soufflé cordonato
Ramekin, fluted
Ramekin, gerippt
Ramequin, cannelé
Fuente soufflé borderizata

art.	Ø cm.	h.
44390-15	15	5,0
44390-18	18	7,5
44390-23	23	8,0

CONTENITORI GN - *FOOD PANS*





Inox, alluminio, policarbonato, polipropilene e porcellana
Stainless steel, aluminum, polycarbonate, polypropylene and porcelain

BACINELLE GASTRONORM, INOX FOOD PANS, STAINLESS STEEL							
	Serie Size	Profondità Depth mm.	lt.	Standard	Maniglie fisse Fixed handles	Maniglie interne Internal handles	Maniglie rientranti Retractable handles
	2/1 650x530 mm	20 40 65 100 150 200	- - 19 31 46 56	14101-02 14101-04 14101-06 14101-10 14101-15 14101-20			- - - 14151-10 14151-15 14151-20
	1/1 530x325 mm	20 40 65 100 150 200	- - 10 15 22 28	14102-02 14102-04 14102-06 14102-10 14102-15 14102-20	- - - 14112-10 14112-15 14112-20	- - - 14142-10 14142-15 14142-20	- - 14152-06 14152-10 14152-15 14152-20
	2/3 353x320 mm	20 40 65 100 150 200	- - 6 9 14 18	14103-02 14103-04 14103-06 14103-10 14103-15 14103-20			
	2/4 162x530 mm	65 100 150	4 6 10	14104-06 14104-10 14104-15			
	1/2 325x265 mm	20 40 65 100 150 200	- - 4 6 10 13	14105-02 14105-04 14105-06 14105-10 14105-15 14105-20	- - - 14115-10 14115-15 14115-20	- - - 14145-10 14145-15 14145-20	- - - 14155-10 14155-15 14155-20
	1/3 325x180 mm	65 100 150 200	3 4 6 8	14107-06 14107-10 14107-15 14107-20	- 14117-10 14117-15 14117-20	- 14147-10 14147-15 14147-20	- 14157-10 14157-15 14157-20
	1/4 265x160 mm	65 100 150 200	2 3 5 6	14108-06 14108-10 14108-15 14108-20	- 14118-10 14118-15 14118-20	- 14148-10 14148-15 14148-20	- 14158-10 14158-15 14158-20
	1/6 176x160 mm	65 100 150 200	1,0 2,0 2,5 3,0	14109-06 14109-10 14109-15 14109-20	- 14119-10 14119-15 -		- 14159-10 14159-15 14159-20
	1/9 176x110 mm	65 100	0,6 1,0	14110-06 14110-10			

INOX - STAINLESS STEEL BACINELLE GASTRONORM FORATE PERFORATED FOOD PANS					
	Serie Size	Profondità Depth mm.	lt.	Standard	Maniglie snodate Folding handles
	2/1 650x530 mm	20	-	14201-02	
		40	-	14201-04	
		65	-	14201-06	
		100	-	14201-10	
		150	-	14201-15	
		200	-	14201-20	
	1/1 530x325 mm	20	-	14202-02	-
		40	-	14202-04	-
		65	-	14202-06	14252-06
		100	-	14202-10	14252-10
		150	-	14202-15	14252-15
		200	-	14202-20	14252-20
	2/3 353x320 mm	65	-	14203-06	
		100	-	14203-10	
		150	-	14203-15	
		200	-	14203-20	
	1/2 325x265 mm	20	-	14205-02	-
		40	-	14205-04	-
		65	-	14205-06	14255-06
		100	-	14205-10	14255-10
		150	-	14205-15	14255-15
		200	-	14205-20	14255-20

Bacinelle profondità mm 20 e 40 forate solo sul fondo. - Containers depth mm 20 and 40 only bottom perforated.



TEGLIE/BACINELLE BAKING SHEETS/PANS			 		 		 
	Serie Size	Profondità Depth mm.	Bacinella inox antiaderente S/S non stick pan	Teglia inox S/S baking pan	Teglia inox antiaderente S/S non stick baking pan	Teglia alluminio Aluminium baking pan	Teglia alluminio antiaderente Aluminium non stick baking pan
	2/1 650x530 mm	20 40 65		14301-02 14301-04 14301-06			
	1/1 530x325 mm	20 40 65	14162-02 14162-04 14162-06	14302-02 14302-04 14302-06	14362-02 14362-04 14362-06	16302-02 16302-04 16302-06	16362-02 16362-04 16362-06
	2/3 353x320 mm	20 40 65		14303-02 14303-04 14303-06		16303-02 16303-04 16303-06	16363-02 16363-04 16363-06
	1/2 325x265 mm	20 40 65	14165-02 14165-04 14165-06	14305-02 14305-04 14305-06	14365-02 14365-04 14365-06	16305-02 16305-04 16305-06	16365-02 16365-04 16365-06

COPERCHI GN LIDS						
Serie Size	Standard	Maniglie Handles	Mestolo Ladle	Maniglie + mestolo Handles + ladle	Guarnizione Trimming	Guarnizione + maniglie Trimming + handles
1/1 530x325 mm	14502-00	14512-00	14522-00	14532-00	14542-00	14552-00
2/3 353x320 mm	14503-00	-	14523-00	-	14543-00	-
2/4 162x530 mm	14504-00	-	-	-	-	-
1/2 325x265 mm	14505-00	14515-00	14525-00	14535-00	14545-00	14555-00
1/3 325x180 mm	14507-00	14517-00	14527-00	14537-00	14547-00	14557-00
1/4 265x160 mm	14508-00	14518-00	14528-00	14538-00	14548-00	14558-00
1/6 176x160 mm	14509-00	14519-00	14529-00	14539-00	14549-00	14559-00
1/9 176x110 mm	14510-00	-	-	-	-	-

CONTENITORI GN INOX STAINLESS STEEL FOOD PANS



Falso fondo forato
Drainer plate
Abtropfplatte
Plateau double fond perforé
Fondo perforado

art.	mod./size
14402-00	1/1
14405-00	1/2
14407-00	1/3



Separatore
Adaptor bar
Stege
Barrette de composition
Perfiles divisorios

art.	mod./size	h. mm.
14409-01	1/1	325
14409-02	2/1	530



Teglia GN 1/1 smaltata
GN 1/1 pan, enamelled
GN 1/1-Ofenblech, emalliert
Bac GN 1/1 émaillé
Cubeta GN 1/1, esmaltada

art.	dim. cm.	h.
44322-02	53x32,5	2,0
44322-04	53x32,5	4,0
44322-06	53x32,5	6,5

Smalto applicato a 800°C dopo un lavaggio chimico che ne permette una perfetta adesione. Ottima resistenza a shock termici - Enamel applied at 800°C after a chemical wash, for perfect adherence. Great resistance to thermal shocks.

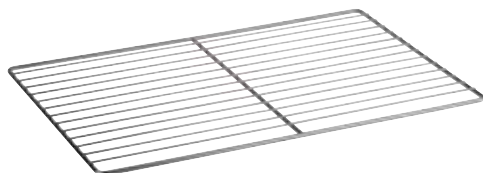

Griglia in filo, inox
Wire grid, stainless steel
Gitter, Edelstahl Rostfrei
Grille, inox
Rejilla, inox

art.	mod./size
44421-00	2/1
44422-00	1/1
44412-00	1/2
44423-00	2/3

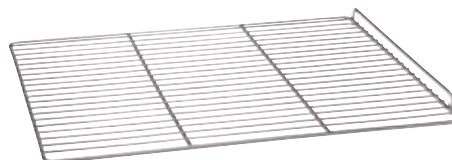

Griglia in filo con sponda, inox
Wire grid with edge, stainless steel
Roste mit Seitenwand, Edelstahl Rostfrei
Grille avec arrêt, inox
Rejilla con borde, inox

art.	mod./size	h. cm.
44432-21	2/1	3



Cesta per friggere, inox
Fry basket, stainless steel
Frittier-Korb, Edelstahl Rostfrei
Panier à frire, inox
Cesta escurrefrito, inox

art.	mod./size	dim. cm.	h.
11750-11	1/1	53x32,5	6

Cesta per friggere da forno, consente di cuocere in pochi minuti e senza grassi grandi quantità di cibi prefritti. La costruzione in filo consente al calore di cuocere facilmente garantendo una doratura uniforme. Una soluzione salutare che permette di eliminare i costi d'acquisto, conservazione e smaltimento degli oli e dei grassi.

This stainless steel oven fry basket is primarily used for cooking fried products in a convection oven. The wire construction allows the oven's dry heat to cook food easily and provides an evenly-browned and crispy finish to foods such as French fries. The basket's size makes it easy to cook large quantities at a time. This healthy alternative to deep-frying also saves space and costs, as it eliminates the need to purchase, store and dispose of oils.



Griglia smaltata
Grid enamelled
Roste, emalliert
Grille émaillé
Rejilla esmaltada

art.	mod./size	dim. cm.
11760-11	1/1	53x32,5











La grigliatura degli alimenti è uno dei metodi di cottura più antichi: è semplice, veloce e dona alle pietanze un sapore caratteristico, ottimale per tutte le preparazioni, carne, pesce e verdure. Ideale per le preparazioni in grande quantità per catering e nella banchettistica, party/feste open-air. Quando la carne viene posta sulla griglia, il calore accumulato fa sì che i pori si chiudano immediatamente, garantendo così una perdita di succhi e peso molto limitata.

Grilling food is one of the oldest methods of cooking, simple and fast it gives a distinctive flavor to dishes, suitable for all preparations, whether meat, fish or vegetables. Ideal for preparation in large quantities for catering and banquets, meals/open-air festivals. When the meat is placed on the grid, the heat stored immediately closes the pores, thus guaranteeing a very poor loss of juice and weight.

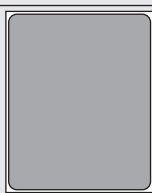
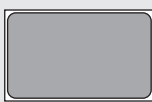

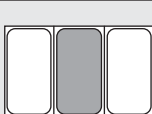
In policarbonato, trasparente ed infrangibile. La superficie liscia dell'interno facilita la pulizia. Resistenti alle macchie, non attaccabili dagli acidi dei cibi, da oli o da alcol. Termoresistenti da -100°C a +100°C. Con scala graduata in litri. Impilabili, sono ideali per la conservazione, trasporto ed esposizione.

Polycarbonate, clear and unbreakable. Smooth surface is easy to clean. Stain resistant, not harmed by food acids, oils or alcohol. Temperature range: -100°C to + 100°C. With metric graduation. Stackable, ideal for storage, transportation and serving display.

POLICARBONATO - POLYCARBONATE BACINELLE GASTRONORM GN FOOD PANS							
	Serie Size	Profondità Depth mm.	lt.	Bacinella Pan	Coperchio Lid	Coperchio con silicone Lid silicone sealing	Griglia Grid
	2/1 650x530 mm	150 200	42 52	14561-15 14561-20	14571-00 Senza traversino No handle		14591-00
	1/1 530x325 mm	65 100 150 200	8 12 18 24	14562-06 14562-10 14562-15 14562-20	14572-00		14592-00
	1/2 325x265 mm	65 100 150 200	3 6 8 11	14565-06 14565-10 14565-15 14565-20	14575-00	14585-00	14595-00
	1/3 325x180 mm	65 100 150 200	2,0 3,5 5,0 6,5	14567-06 14567-10 14567-15 14567-20	14577-00		14597-00
	1/4 265x160 mm	65 100 150 200	1,5 2,5 3,5 4,5	14568-06 14568-10 14568-15 14568-20	14578-00		14598-00
	1/6 176x160 mm	65 100 150 200	0,7 1,2 2,0 2,5	14569-06 14569-10 14569-15 14569-20	14579-00		14599-00
	1/9 176x110 mm	65 100	0,5 0,7	14570-06 14570-10	14580-00		



Realizzati con materiali approvati FDA. Studiati e realizzati in ottemperanza alla normativa UNI EN 631-1. Ottima resistenza agli urti. Eccellente trasparenza (0,6 HAZE). Pareti completamente lisce per permettere di identificare facilmente il contenuto e per agevolare il lavaggio. Dotati di scala graduata sia secondo sistema metrico che americano. Gradino di sovrapposibilità che consente agevole impilaggio. Utilizzabili nel microonde ma non per tempi prolungati. Sopportano temperature da -40°C a +110°C. Fondo esternamente foto-inciso anti-graffio. AVVERTENZE - I contenitori in polycarbonato non sono raccomandati per l'uso su tavole a vapore; evitare il contatto con sapone di Marsiglia. Per il lavaggio si consiglia l'utilizzo di detersivi con PH neutro e, in ogni caso, con PH inferiore a 11. L'utilizzo di detersivi fortemente alcalini (PH>11) o a base di alcool, solventi clorurati, ammoniaca e l'impiego di spugne abrasive potrebbe danneggiare irrimediabilmente i prodotti.

Made with FDA approved materials. Designed and manufactured in compliance with UNI EN 631 1. Excellent resistance to shocks. Excellent transparency (HAZE 0.6). Walls completely smooth to allow easy identification of content and easy cleaning. Graduated scale according to both metric and American system. Nest for easy storage. Can be used in microwave ovens but not for prolonged times. Withstands temperatures from -40°C to +110°C. External bottom photo etched anti scratch. WARNING - Polycarbonate containers are not recommended for use on steam tables, avoid contact with soap. For cleaning we recommend detergents with neutral pH and, in any case, with a pH less than 11. The use of detergents strongly alkaline (pH>11) or alcohol, chlorinated solvents, ammonia and abrasive pads may irreparably damage the product.







POLICARBONATO - POLYCARBONATE BACINELLE GASTRONORM GN FOOD PANS								
	Serie Size	Profondità Depth mm.	lt.	Bacinella Pan	Coperchio Lid	Coperchio ermetico Hermetic lid	Mestolo Ladle	Falso fondo Drainer
	2/1 650x530 mm	200	55,5	14801-20	14811-00		14821-00	14851-00
	1/1 530x325 mm	65 100 150 200	9,0 13,3 20,0 26,4	14802-06 14802-10 14802-15 14802-20	14812-00	14832-00	14822-00	14852-00
	1/2 325x265 mm	65 100 150 200	4,0 6,1 9,0 11,9	14805-06 14805-10 14805-15 14805-20	14815-00	14835-00	14825-00	14855-00
	1/3 325x175 mm	65 100 150 200	2,5 3,8 5,5 7,1	14807-06 14807-10 14807-15 14807-20	14817-00	14837-00	14827-00	
	1/4 264x162 mm	65 100 150 200	1,7 2,6 3,8 4,8	14808-06 14808-10 14808-15 14808-20	14818-00	14838-00	14828-00	
	1/6 176x162 mm	65 100 150 200	1,0 1,6 2,3 2,8	14809-06 14809-10 14809-15 14809-20	14819-00	14839-00	14829-00	
	1/9 176x108 mm	65 100	0,6 0,9	14810-06 14810-10	14820-00	14840-00	14830-00	

I coperchi della serie 14800 polycarbonato e 14600 Tritan sono intercambiabili. Coperchi ermetici, NON a tenuta stagna.

The lids of the series 14800 polycarbonate and 14600 Tritan are interchangeable. Hermetic lids, NOT water-tight.



BACINELLE GASTRONORM, TRITAN - GN FOOD PANS, TRITAN
COPOLIMERO - COPOLYMER - BPA FREE -40°C+90°C

	Serie Size	Profondità Depth mm.	lt.	Bacinella Pan	Coperchio Lid	Coperchio ermetico Hermetic lid	Falso fondo Drainer
	2/1 650x530 mm	200	55,5	14661-20	14671-00		14691-00
	1/1 530x325 mm	65 100 150 200	9,0 13,3 20,0 26,4	14662-06 14662-10 14662-15 14662-20	14672-00	14682-00	14692-00
	1/2 325x265 mm	65 100 150 200	4,0 6,1 9,0 11,9	14665-06 14665-10 14665-15 14665-20	14675-00	14685-00	14695-00
	1/3 325x175 mm	65 100 150 200	2,5 3,8 5,5 7,1	14667-06 14667-10 14667-15 14667-20	14677-00	14687-00	
	1/4 264x162 mm	65 100 150 200	1,7 2,6 3,8 4,8	14668-06 14668-10 14668-15 14668-20	14678-00	14688-00	
	1/6 176x162 mm	65 100 150 200	1,0 1,6 2,3 2,8	14669-06 14669-10 14669-15 14669-20	14679-00	14689-00	
	1/9 176x108 mm	65 100	0,6 0,9	14670-06 14670-10	14680-00	14690-00	













I coperchi della serie 14800 policarbonato e 14600 Tritan sono intercambiabili.
Coperchi ermetici, NON a tenuta stagna.

The lids of the series 14800 polycarbonate and 14600 Tritan are interchangeable.
Hermetic lids, NOT water-tight.



Traslucide e resistenti, impilabili, leggere e maneggevoli. Realizzate in polipropilene alimentare, conformi alle normative alimentari internazionali. Non si impregnano di odori e sapori. Lavabili a mano o in lavastoviglie con normali detersivi. Non utilizzare pagliette d'acciaio o ruvide, evitare l'uso di sostanze abrasive. Termoresistenti da -40°C a +100°C. Scala di graduazione in litri per un controllo istantaneo della quantità. Coperchio resistente per una perfetta chiusura stagna. Utilizzabili per la refrigerazione, lo stoccaggio, trasporto, esposizione e distribuzione di tutti i tipi di alimenti.













Made in polypropylene, full compliance with food contact sanitation requirements, light, odourless, transparent, dish-washer safe, unbreakable. Cold resistant up to -40°C - Heat resistant up to +100°C. Easily cleanable, designed to allow for nesting empty containers within one another and stacking bottoms a top of lids. Provided with metric graduation. Lids tightly fitting. Ideal for commercial food processing and handling facilities. Can be used in all public places where food is prepared, hot/cold stored or served, for holding and display.

POLIPROPILENE - POLYPROPYLENE BACINELLE GASTRONORM FOOD PANS										
	Serie Size	Profondità Depth mm.	lt.	Bacinella Pan	Griglia Grid	Coperchio - Lid Neutro - Clear	Coperchio - Lid Blu - Blue	Coperchio - Lid Rosso - Red	Coperchio - Lid Giallo - Yellow	Coperchio - Lid Verde - Green
	1/1 530x325 mm	65 100 150 200	8 12 18 24	14702-06 14702-10 14702-15 14702-20	14712-00	14722-99	14722-00	14722-11	14722-22	14722-33
	1/2 325x265 mm	65 100 150 200	3 6 8 11	14705-06 14705-10 14705-15 14705-20	14715-00	14725-99	14725-00	14725-11	14725-22	14725-33
	1/3 325x180 mm	65 100 150 200	2,0 3,5 5,0 6,5	14707-06 14707-10 14707-15 14707-20	14717-00	14727-99	14727-00	14727-11	14727-22	14727-33
	1/4 265x160 mm	65 100 150	1,5 2,5 3,5	14708-06 14708-10 14708-15	14718-00	14728-99	14728-00	14728-11	14728-22	14728-33
	1/6 176x160 mm	65 100 150	0,7 1,2 2,0	14709-06 14709-10 14709-15	14719-00	14729-99	14729-00	14729-11	14729-22	14729-33
	1/9 176x110 mm	65 100	0,5 0,7	14710-06 14710-10		14730-99	14730-00	14730-11	14730-22	14730-33



Realizzati con materiali approvati FDA. Eccellente soluzione economica per la preparazione, esposizione e conservazione dei cibi. Ottima resistenza agli urti a temperatura ambiente. Buona trasparenza che permette di identificare facilmente il contenuto al proprio interno. Sopportano temperature da -40°C a +80°C. Dotati di scala graduata sia secondo sistema metrico che americano. Gradino disovrapponibilità che consente agevole impilaggio. Disponibili con coperchi ermetici trasparenti o colorati. AVVERTENZE: I contenitori in polipropilene non sono indicati per l'uso su tavole a vapore.

Made with FDA approved materials. Excellent economical solution for the preparation, display and storage of foods. Excellent impact resistance at room temperature. Good transparency that allows to easily identify the contents. Withstands temperatures from -40°C to +80°C. With both metric and American graduated scale. Nest for easy storage. Available clear or colored airtight lids. WARNING: polypropylene containers are not suitable for use on steam tables.

POLIPROPILENE - POLYPROPYLENE BACINELLE GASTRONORM FOOD PANS										
	Serie Size	Profondità Depth mm.	lt.	Bacinella Pan	Falso fondo Drainer plate	Coperchio ermetico Hermetic Lid Neutro - Clear	Coperchio ermetico Hermetic Lid Blu - Blue	Coperchio ermetico Hermetic Lid Rosso - Red	Coperchio ermetico Hermetic Lid Giallo - Yellow	Coperchio ermetico Hermetic Lid Verde - Green
	1/1 530x325 mm	65 100 150 200	9,0 13,3 20,0 26,4	14902-06 14902-10 14902-15 14902-20	14912-00	14922-99	14922-00	14922-11	14922-22	14922-33
	1/2 325x265 mm	65 100 150 200	4,0 6,1 9,0 11,9	14905-06 14905-10 14905-15 14905-20	14915-00	14925-99	14925-00	14925-11	14925-22	14925-33
	1/3 325x175 mm	65 100 150 200	2,5 3,8 5,5 7,1	14907-06 14907-10 14907-15 14907-20		14927-99	14927-00	14927-11	14927-22	14927-33
	1/4 264x162 mm	65 100 150 200	1,7 2,6 3,8 4,8	14908-06 14908-10 14908-15 14908-20		14928-99	14928-00	14928-11	14928-22	14928-33
	1/6 176x162 mm	65 100 150 200	1,0 1,6 2,3 2,8	14909-06 14909-10 14909-15 14909-20		14929-99	14929-00	14929-11	14929-22	14929-33
	1/9 176x108 mm	65 100	0,6 0,9	14910-06 14910-10		14930-99	14930-00	14930-11	14930-22	14930-33

I coperchi della serie 14900 polipropilene e 15100 polipropilene IML sono intercambiabili.
Coperchi ermetici, NON a tenuta stagna.

The lids of the series 14900 polypropylene and 15100 polypropylene IML are interchangeable.
Hermetic lids, NOT water-tight.

Realizzati con materiali approvati FDA. Con etichetta permanente grazie alla tecnologia IML che consente di avere un'etichetta costampata, niente più etichette adesive che tendono a lasciare residui appiccicosi richiedendo poi operazioni di raschiatura. I contenitori in polipropilene IML aiutano a garantire la sicurezza e l'igiene degli alimenti secondo la normativa HACCP. Sono disponibili sia con coperchi colorati che con coperchi trasparenti con sede per COLOR CLIPS per evitare la contaminazione tra i vari alimenti. Per scrivere sull'etichetta è disponibile un pennarello specifico che viene rimosso con il semplice lavaggio in lavastoviglie. Ottima resistenza agli urti a temperatura ambiente. Buona trasparenza che permette di identificare facilmente il contenuto al proprio interno. Sopportano temperature da -40°C a +80°C. Dotati di scala graduata sia secondo sistema metrico che americano. Gradino di sovrapponibilità che consente agevole impilaggio. AVVERTENZE - I contenitori in polipropilene non sono indicati per l'uso su tavole a vapore.

Made with FDA approved materials. With permanent label thanks to the IML technology that allows you to obtain an in molded label. No more labels that leave sticky residue requiring scraping operations. The IML polypropylene containers help ensure the safety and hygiene of food according to HACCP standards. They are available with colored lids or transparent lids with COLOR CLIPS to prevent contamination between different foods. To write on the label there is a specific marker that can be removed by simply washing in the dishwasher. Excellent impact resistance at room temperature. Good transparency that allows you to easily identify the contents. Withstands temperatures from -40°C to +80°C. With both metric and American graduated scale. Nest for easy storage. WARNING: polypropylene containers are not suitable for use on steam tables.



**POLIPROPILENE - POLYPROPYLENE
BACINELLE GASTRONORM
FOOD PANS**



	Serie Size	Profondità Depth mm.	lt.	Bacinella Pan	Falso fondo Drainer plate	Coperchio ermetico Hermetic Lid Neutro - Clear	Coperchio ermetico Hermetic Lid Blu - Blue	Coperchio ermetico Hermetic Lid Rosso - Red	Coperchio ermetico Hermetic Lid Giallo - Yellow	Coperchio ermetico Hermetic Lid Verde - Green
	1/1 530x325 mm	65 100 150 200	9,0 13,3 20,0 26,4	15101-06 15101-10 15101-15 15101-20	14912-00	14922-99	14922-00	14922-11	14922-22	14922-33
	1/2 325x265 mm	65 100 150 200	4,0 6,1 9,0 11,9	15105-06 15105-10 15105-15 15105-20	14915-00	14925-99	14925-00	14925-11	14925-22	14925-33
	1/3 325x175 mm	65 100 150 200	2,5 3,8 5,5 7,1	15107-06 15107-10 15107-15 15107-20		14927-99	14927-00	14927-11	14927-22	14927-33
	1/4 264x162 mm	65 100 150 200	1,7 2,6 3,8 4,8	15108-06 15108-10 15108-15 15108-20		14928-99	14928-00	14928-11	14928-22	14928-33
	1/6 176x162 mm	65 100 150 200	1,0 1,6 2,3 2,8	15109-06 15109-10 15109-15 15109-20		14929-99	14929-00	14929-11	14929-22	14929-33
	1/9 176x108 mm	65 100	0,6 0,9	15110-06 15110-10		14930-99	14930-00	14930-11	14930-22	14930-33







**ACCESSORI
ACCESSORIES**



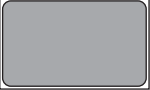

Clips Giallo - Yellow	Clips Blu - Blue	Clips Rosso - Red	Clips Verde - Green	Set 2 pennarelli Kit 2 markers
15100-01	15100-02	15100-03	15100-04	15100-AA
u. pack 12 pz/pcs	u. pack 12 pz/pcs	u. pack 12 pz/pcs	u. pack 12 pz/pcs	u. pack 2 pz/pcs

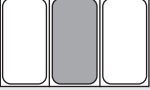
I coperchi della serie 14900 polipropilene e 15100 polipropilene IML sono intercambiabili. Coperchi ermetici, NON a tenuta stagna.

The lids of the series 14900 polypropylene and 15100 polypropylene IML are interchangeable. Hermetic lids, NOT water-tight.



 BACINELLE GN - FOOD PANS	Serie Size HIGH-LINE	Profondità Depth mm.	lt.	Bacinella Pan
	1/1 530x325 mm	65 100	7,10 11,00	44883-11 44879-11
	2/3 350x325 mm	65	4,60	44883-23
	2/4 160x530 mm	65	3,00	44883-24
	1/2 325x265 mm	65 100	3,40 5,50	44883-12 44879-12
	1/3 325x175 mm	65 100	2,00 3,15	44883-13 44879-13
	1/4 265x160 mm	65 100	1,35 2,20	44883-14 44879-14
	1/6 175x160 mm	65 100	0,80 1,25	44883-16 44879-16

 BACINELLE GN - FOOD PANS	Serie Size ECO-LINE	Profondità Depth mm.	lt.	Bacinella Pan
	1/1 530x325 mm	65 100	7,10 10,60	44878-11 44878B11
	2/4 160x530 mm	65 100	3,00 4,30	44878-24 44878B24
	1/2 325x265 mm	65 100	3,40 4,70	44878-12 44878B12
	1/3 325x175 mm	65 100	2,00 2,70	44878-13 44878B13
	1/4 265x160 mm	65 100	1,35 1,90	44878-14 44878B14
	1/6 175x160 mm	65 100	0,80 1,00	44878-16 44878B16









GN PORCELLANA PORCELAIN FOOD PANS	Serie Size	Profondità Depth mm.	Bacinella bianca White pan		Bacinella nera Black pan
	1/1 530x325 mm	20 65	44332-03 44332-06		44332B06
	2/3 353x320 mm	20 65	44333-03 44333-06		44333B06
	2/4 162x530 mm	20 65	44334-03 44334-06		
	1/2 325x265 mm	20 65	44335-03 44335-06		44335B06
	1/3 325x180 mm	20 65	44337-03 44337-06		44337B06
	1/4 265x160 mm	20 65	44338-03 44338-06		
	1/6 176x160 mm	20 65	44339-03 44339-06		



Per i professionisti del settore. Teglie gastronomiche in porcellana con sistema induzione adatte per l'utilizzo su ogni generatore, per il mantenimento del caldo. L'induzione offre un preciso controllo della temperatura con minori consumi energetici e tempi di esercizio. La potenza consigliata per un perfetto utilizzo è di 800W. *For professionals. Porcelain hotel food pans with induction system are designed for use on each generator to maintain the heat. The induction provides precise temperature control with lower energy consumption and cooking times. The recommended power for a perfect use is 800W.*

GN PORCELLANA INDUZIONE
PORCELAIN FOOD PANS INDUCTION READY

	Serie Size	Profondità Depth mm.	Bacinella Pan
	1/1 530x325 mm	65	44342-06○ 44342B06● 44342G06● 44342O06● 44342R06● 44342Y06●
	2/3 350x320 mm	65	44343-06○ 44343B06● 44343G06● 44343O06● 44343R06● 44343Y06●
	2/4 162x530 mm	65	44344-06○ 44344B06● 44344G06● 44344O06● 44344R06● 44344Y06●
	1/2 325x265 mm	65	44345-06○ 44345B06● 44345G06● 44345O06● 44345R06● 44345Y06●
	1/4 265x162 mm	65	44346-06
	1/3 325x176 mm	65	44347-06○ 44347B06● 44347G06● 44347O06● 44347R06● 44347Y06●



**UTENSILI DA CUCINA
KITCHEN UTENSILS
KÜCHENZUBEHÖRE
USTENSILES DE CUISINE
UTENSILIOS DE COCINA**

P SERIE 12900 PA+[®]
plus

Un'ampia gamma di utensili professionali per la cucina in materiale composito, poliammide (nylon 6.6) con fibra di vetro. Lavabili in lavastoviglie, sterilizzabili, resistenti fino a 220°C. Ideali per l'uso con antiaderenti.

A wide range of professional kitchen utensils in composite material, polyamide (nylon 6.6) with fiberglass. Dishwasher safe, can be sterilized, heat resistant up to 220°C. Safe for non-stick cookware.



Cucchiaione
Spoon
Löffel
Mouvette
Cuchara

PA+
plus

art.	l. cm.
12903-30	30
12903-40	38
12903-45	45



Spatola
Spatula
Teigschäber
Spatule
Espátula

PA+
plus

art.	l. cm.
12905-25	25
12905-30	30
12905-35	35
12905-40	40
12905-45	45
12905-50	50



Spatola per stemperare
Stirring ladle
Rühr-u. Temperierlöffel
Spatule à délayer
Espátula para diluir

PA+
plus

art.	l. cm.
12907-07	35
12907-08	35



Spatola
Spatula
Stielschäber
Spatule
Espátula

PA+
plus

art.	l. cm.
12915-25	25
12915-26	28
12915-35	35
12915-45	45



Spatola
Spatula
Teigschäber
Spatule
Espátula

PA+
plus

art.	l. cm.
12916-25	25
12916-33	33



Spatola triangolare
Spatula
Dreieck-Stielschäber
Spatule trilon
Espátula triangular

PA+
plus

art.	l. cm.
12917-25	25



Spatola smussata
Bevelled spatula
Teigschäber
Spatule plate biseauté
Espátula blanda

PA+
plus

art.	l. cm.
12906-35	35



Spatola
Spatula
Teigschäber
Spatule
Espátula

PA+
plus

art.	l. cm.
12908-30	30
12908-35	35
12908-40	40



Paletta angolare
Angular spatula
Winkelpalette
Spatule angulaire
Espátula

PA+
plus

art.	l. cm.
12909-12	12
12909-23	23



Paletta forata
Spatula, perforated
Teigschäber, perforiert
Spatule ajourée
Espátula perforada

PA+
plus

art.	l. cm.
12921-01	30



Paletta forata
Spatula, perforated
Teigschäber, perforiert
Spatule ajourée
Espátula perforada

PA+
plus

art.	l. cm.
12921-05	30



Paletta
Spatula
Teigschäber
Spatule
Espátula

PA+
plus

art.	l. cm.
12921-10	32

UTENSILI KITCHEN UTENSILS



Paletta fritti
Fish & chips spatula
Fischheber
Pelle à friture
Espátula fritura

PA+
plus

art. l. cm.
12921-15 35



Mestolo
Ladle
Schöpföffel
Louche
Cacillo

PA+
plus

art. ø cm. l.
12920-01 9 31



Schiumarola
Skimmer
Schaumlöffel
Ecumoire
Espumadera

PA+
plus

art. ø cm. l.
12920-05 11 35



Paletta
Spatula
Teigschäber
Spatule
Espátula

PA+
plus

art. dim. cm. l.
12920-10 9x10 35



Paletta fritti
Fish & chips spatula
Fischheber
Pelle à friture
Espátula fritura

PA+
plus

art. dim. cm. l.
12920-11 9x10 35



Cucchiaione
Spoon
Gießlöffel
Cuillère
Cucharón

PA+
plus

art. l. cm.
12920-15 35



Cucchiaione forato
Perforated spoon
Gießlöffel, perforiert
Cuillère perforée
Cucháron perforado

PA+
plus

art. l. cm.
12920-16 35



Molla insalata
Salad tong
Salatzange
Pince à salade
Pinza ensalada

PA+
plus

art. l. cm.
12930-51 25
12930-52 32



Molla per pane e pasticceria
Bread and pastry tong
Brot-/Gebäckzange
Pince à pain et pâtisserie
Pinza para pan y pastelería

PA+
plus

art. l. cm.
12930-62 18
12930-63 23



Molla tutto servire
Serving tong
Servierzange
Pince à servir
Pinza servir

PA+
plus

art. l. cm.
12930-68 20
12930-69 25



Molla spaghetti
Spaghetti tong
Spaghettizange
Pince à spaghetti
Pinza espagueti

PA+
plus

art. l. cm.
12930-74 24



Molla per toast e dolci
Toast and pastry tong
Toast-/Gebäckzange
Pince à toast et tarte
Pinza para tostadas y dulces

PA+
plus

art. l. cm.
12930-77 21
12930-78 25



Forbice per polpette
Meat ball plier
Fleischkugelzange
Pince à boulettes
Pinza albóndigas

PA+
plus

art. l. cm.
12931-51 17



Forbice per chenelle
Quenelle plier
Quenellezange
Pince à quenelles
Pinza quenelles

PA+
plus

art. l. cm.
12931-53 19



Mestolo forato
Perforated ladle
Schöpflöffel, gelocht
Louche perforée
Cacillo perforado

PA+
plus

art. cm. l.
12967-06 6,5 30,0
12967-10 10,0 37,5



PAT. pend.

Mestolo
Ladle
Schöpflöffel
Louche
Cacillo

PA+
plus

art. ø cm. l.
12970-06* 6,5 30
12970-08 8,0 33,5
12970-10 10,0 37,5
12970-12 12,0 40,0

*Con becco. - With spout.



Mestolo pizza, fondo piatto
Pizza ladle, flat bottom
Schöpflöffel
Louche
Cacillo

PA+
plus

art. ø cm. l.
12968-10 10 27

Il fondo piatto distribuisce uniformemente
la salsa di pomodoro senza lasciare scie.
The flat bottom evenly distributes tomato
sauce without leaving streaks.



Mestolo, manico corto
Ladle, short handle
Schöpflöffel mit kurzen Stiel
Louche, manche court
Cacillo, mango corto

PA+
plus

art. ø cm. l.
12969-10 10,0 27



Mestolo, manico corto
Ladle, short handle
Schöpflöffel mit kurzen Stiel
Louche, manche court
Cacillo, mango corto

PA+
plus

art. ø cm. l.
12969-06 6,5 24



Cucchiaione
Spoon
Löffel
Cuillère
Cuchara

PA+
plus

art. l. cm.
12982-38 37,5



Cucchiaione
Spoon
Löffel
Cuillère
Cuchara

PA+
plus

art. l. cm.
12986-38 37,5



Cucchiaione, manico corto
Spoon, short handle
Löffel mit kurzen Stiel
Cuillère, manche court
Cuchara, mango corto

PA+
plus

art. l. cm.
12982-01 23



Cucchiaione, manico corto
Spoon, short handle
Löffel mit kurzen Stiel
Cuillère, manche court
Cuchara, mango corto

PA+
plus

art. l. cm.
12986-01 23



Schiumarola
Skimmer
Schaumlöffel
Ecumoire
Espumadera

PA+
plus

art. ø cm. l.
12971-10 10 31
12971-12 12 37

UTENSILI KITCHEN UTENSILS



Paletta liscia
Spatula
Backschaufel
Spatule
Espátula lisa

PA+
plus

art.	cm.	l.
12972-10	10	36,5
12972-12	12	38,0



Paletta forata
Perforated spatula
Backschaufel, perforiert
Spatule perforée
Espátula perforada

PA+
plus

art.	cm.	l.
12973-10	10	36,5
12973-12	12	38,0



Colatutto, inox
Strainer, stainless steel
Sieb, Edelstahl Rostfrei
Passoire, inox
Colador multiuso, inox

PA+
plus

art.	dim. cm.	l.
12932-22	22x18,5	44
12932-26	26x21	47



Colino a rete, inox
Soup strainer, s/s
Suppensieb, Edelstahl Rostfrei
Passe-bouillon, inox
Colador a red, inox

PA+
plus

art.	ø cm.	l.
12941-07	7	12
12941-10	10	12
12941-12	12	17
12941-14	14	17
12941-16	16	17
12941-18	18	17
12941-20	20	17
12941-23	23	27
12941-26	26	27



Colatutto tronco conico
Conical colander
Gemüsesieher
Passoire à légumes
Colador cónico

PA+
plus

art.	ø cm.	h.	lt.
12950-32	32	16	8
12950-40	40	20	12



Frusta, 8 fili silicone
Wire whip, 8 Silicone wires
Rührbesen, 8 Drähte aus Silikon
Fouet, 8 fils en silicone
Batidor, 8 varillas de silicenea

PA+
plus

art.	l. cm.
12926-35	35

La forma tonda progettata per incorporare più aria possibile nelle miscele, è perfetta per sbattere più rapidamente ed efficientemente i bianchi d'uovo per soufflé eterei e meringhe, per panna montata e per creare ripieni e guarnizioni soffici. - *Balloon shape accomplishes tasks from beating eggs to blending sauces quickly and efficiently. Its shape is designed to incorporate as much air as possible into your mixture. Sturdy and versatile, perfect for beating egg whites for ethereal soufflés and meringues. Or use it for whipping cream to create light, fluffy fillings and toppings.*



PA+
plus

Frusta, 8 fili, inox
Wire whip, 8 wires, stainless steel
Rührbesen, 8 Drähte, Edelstahl Rostfrei
Fouet, 8 fils, inox
Batidor, 8 varillas, inox

art.	l. cm.
12928-25	25
12928-30	30
12928-35	35
12928-40	40
12928-45	45
12928-50	50
12928-55	55
12928-60	60

Perfetta tenuta stagna, lavabile in lavastoviglie. - *Water-tight, dishwasher safe.*



PA+
plus

Frusta media, 11 fili, inox
Egg whisk, 11 wires, stainless steel
Schneebeisen, 11 Drähte, Edelstahl
Fouet, 11 fils, inox
Batidor, 11 varillas, inox

art.	l. cm.
12929-25	25
12929-30	30
12929-35	35
12929-40	40
12929-45	45

Perfetta tenuta stagna, lavabile in lavastoviglie. - *Water-tight, dishwasher safe.*



PA+
plus

Frusta balloon, inox
Balloon whisk, stainless steel
Schneebeisen, Edelstahl Rostfrei
Fouet à blancs, inox
Batidor tipo globo, inox

art.	l. cm.
12927-35	35
12927-45	45

Perfetta tenuta stagna, lavabile in lavastoviglie. - *Water-tight, dishwasher safe.*

POLICARBONATO - POLYCARBONATE



Mestolo per sangria
Sangria ladle
Sangrialöffel
Louche à sangria
Cucharón para sangría

art.	ø cm.	l.
44929-02	6,5	29



Cucchiaine
Spoon
Löffel
Cuillère
Cuchara

art.	l. cm.
44929-03	35



Cucchiaine forato
Perforated spoon
Löffel, gelocht
Cuillère percée
Cuchara perforada

art.	l. cm.
44929-04	35



Molla concava
Utility tong
Servierzange
Pince à servir
Pinza para servir

art.	l. cm.
44929-05	23
44929-06	30



Molla ghiaccio
Ice tong
Eiszange
Pince à glace
Pinza para hielo

art.	l. cm.
44929-09	16



Molla a servire
Serving tong
Servierzange
Pince à servir
Pinza para servir

art.	l. cm.
44929-07	20,5



Forbice per pane e dolci
Bread and pastry plier
Brot u. Gebäckzange
Pince à pain et pâtisserie
Pinza pan y pasteles

art.	l. cm.
44929-11	22



Molla spaghetti
Spaghetti tong
Spaghettizange
Pince à spaghetti
Pinza espagueti

art.	l. cm.
44929-08	23,5



Sessola
Flour scoop
Mehlschaufel
Pelle à farine
Librador

art.	lt.
14959-01	0,10
14959-02	0,25
14959-05	0,50
14959-10	1,00
14959-20	2,00

SPATOLE - TURNERS



Spatole in acciaio inox con manico in polipropilene.

Stainless steel turners with polypropylene handle.



Paletta forata
Perforated spatula
Kuchenpalette, geschlitzt
Palette perforée
Paleta perforada

art. dim. cm.
18510-07 13,5x7



Spatola forata
Perforated spatula
Kuchenpalette, geschlitzt
Palette perforée
Paleta perforada

art. dim. cm.
18509-01 16x7,5
18509-02 15,6x5



Paletta forata, flessibile
Perforated spatula, flexible
Palette, geschlitzt, flexibel
Palette perforée, flexible
Paleta perforada, flexible

art. dim. cm.
18509-03 15,6x8,7



Spatola per pasticcio e pizza
Pizza turner
Pizzawender
Palette à pizza
Espátula pizza

art.	dim. cm.
18511-15	15,5x8,7



Spatola hamburger
Hamburger turner
Hamburgerspachtel
Palette à hamburger
Espátula hamburger

art.	dim. cm.
18512-15	19x13,8



Spatola lasagne
Lasagne spatula
Lasagneheber
Palette à lasagne
Espátula lasagna

art.	dim. cm.
18515-16	16,8x7,2



Spatola triangolare
Cleaning spatula
Bratenspachtel
Spatule
Espátula triangular

art.	dim. cm.
18520-04	12x4
18520-06	12x6
18520-08	12x8
18520-10	12x10
18520-12	12x12



Spatola hamburger
Hamburger turner
Bratenwender
Grand palette
Espátula hamburger

art.	dim. cm.
18516-24	24x7,2



Spatola hamburger, forata
Perforated hamburger turner
Bratenspachtel, gelocht,
Grand palette perforée
Espátula hamburger, perforada

art.	dim. cm.
18517-24	24x7,2



Spatola cuoco con scalino
Angular spatula
Confiseriepalette
Palette coudée
Espátula chef angular

art.	dim. cm.
18518-22	22x3,4
18518-26	25x3,7
18518-30	30x4,3



Spatola cuoco
Spatula
Palette
Palette
Espátula chef

art.	dim. cm.
18519-15	15,5x3
18519-22	22x3,4
18519-26	26x3,7
18519-30	31x4,3
18519-35	36x5



Paletta dolci
Pastry spatula
Gebäckpalette
Palette à gâteau
Pala dulces

art.	dim. cm.
18513-14	14,5x6,5



Spatola dolce
Pastry spatula
Kuchenpalette
Palette à pâtissier
Espátula dulces

art.	dim. cm.
18514-17	16,3x5,8



Coltello torta
Pie knife
Tortenmesser
Couteau à gâteau
Cuchillo pasteles

art.	dim. cm.
18514-18	17,3x5,8



Coltello lasagne
Lasagne knife
Lasagnemesser
Couteau à lasagne
Cuchillo lasagna

art.	l. cm.
18216-22	22

MESTOLI - LADLES

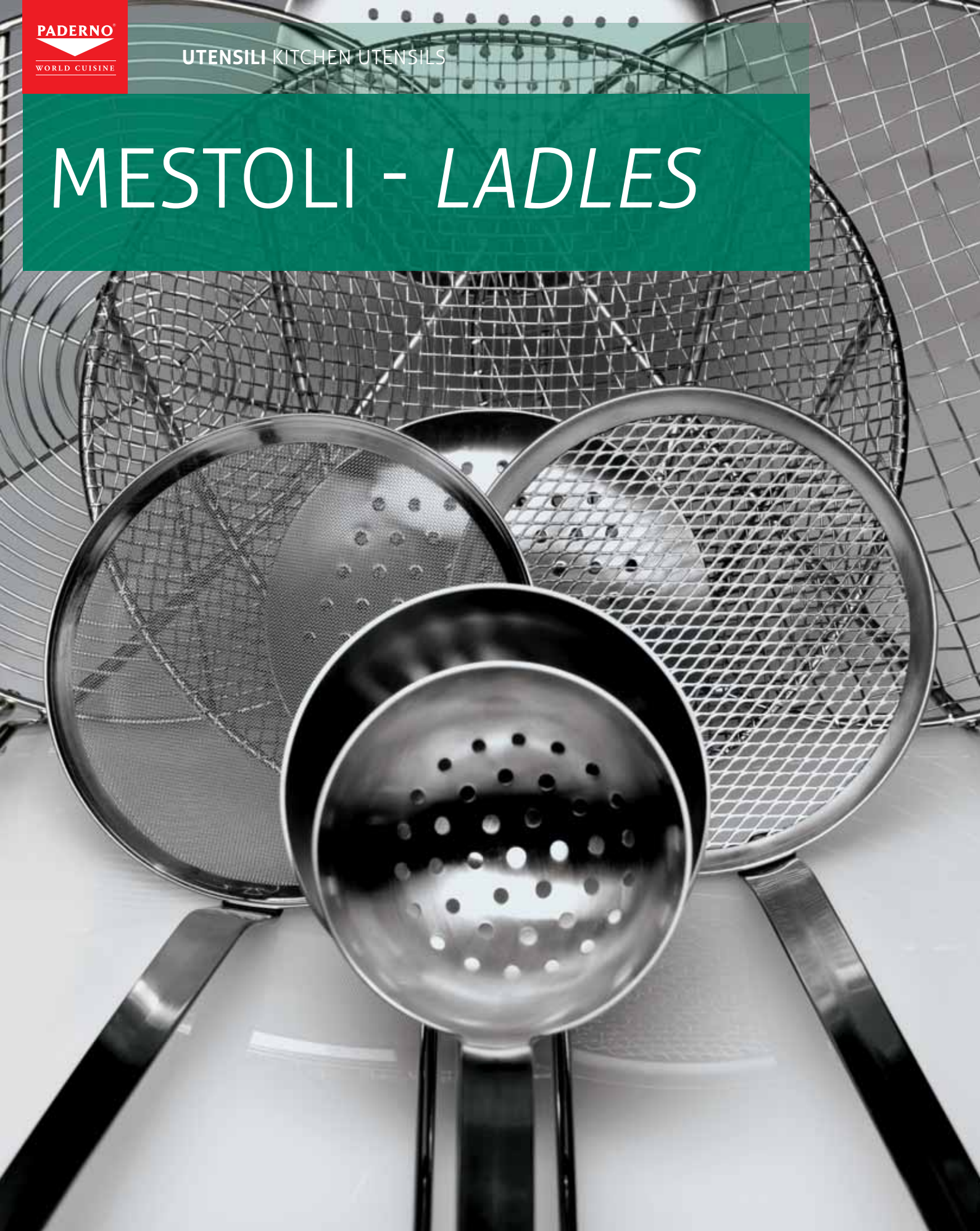

Il mestolo PADERNO.
Accoppiamento manico-coppa (mestolo unipezzo). Manico con spessore maggiorato con bordi arrotondati. Indicazione sul manico del diametro e della capacità.

*The PADERNO ladle.
Handle-cup connection (one piece ladle). Thicker handle with rounded border. Diameter and capacity stamped on the handle.*



Mestolo unipezzo, inox
One piece ladle, stainless steel
Schöpflöffel, fugenlos, Edelstahl Rostfrei
Louche monobloc, inox
Cacillo monobloc, acero inox

art.	ø cm.	l.	lt.
11970-06	6,5	30	0,07
11970-08	8,0	32	0,12
11970-09	9,0	33	0,20
11970-10	10,0	37	0,25
11970-11	11,0	38	0,33
11970-12	12,0	40	0,50
11970-14	14,0	44	0,75
11970-16	16,0	47	1,00



Mestolo con manico a tubo, inox
Ladle, tube handle, stainless steel
Schöpflöffel mit Rohrsteel, Edelstahl
Louche avec manche tubulaire, inox
Cacillo con mango tubolar, acero inox

art.	ø cm.	l.	lt.
11968-18	18	75	1,5
11968-20	20	75	2,0
11968-24	24	75	4,0



Mestolo forato unipezzo, inox
One piece perforated ladle, s/s
Gelochter Schöpflöffel, fugenlos, E. R.
Louche monobloc perforée, inox
Cacillo monobloc perforado, inox

art.	ø cm.	l.	lt.
11967-06	6,5	30	0,07
11967-08	8,0	32	0,12
11967-09	9,0	33	0,20
11967-10	10,0	37	0,25
11967-12	12,0	40	0,50
11967-14	14,0	44	0,75
11967-16	16,0	47	1,00



Mestolo forato con manico a tubo, inox
Perforated ladle, tube handle, s/s
Schöpflöffel, gelocht mit Rohrsteel, E. R.
Louche perforée, manche tubulaire, inox
Cacillo perforado mango tubolar, inox

art.	ø cm.	l.	lt.
11967-18	18	75	1,5
11967-20	20	75	2,0
11967-24	24	75	4,0



Mestolo becco a versare unipezzo, inox
One piece side basting spoon, s/s
Saucenkelle quer, fugenlos, Edelstahl
Cuillère à arroser monobloc, inox
Cacillo monobloc para versar, inox

art.	ø cm.	l.	lt.
11969-06	6,5	30	0,07



Mestolo per mancini, inox
Side basting spoon, left handed, s/s
Saucenkelle für Linkshänder, Edelstahl
Cuillère à arroser, gaucher, inox
Cacillo para zurdos, inox

art.	ø cm.	l.	lt.
11969-37	6,5	30	0,07



Cucchiaione unipezzo, inox
One piece basting spoon, stainless steel
Giesslöffel, fugenlos, Edelstahl Rostfrei
Cuillère monobloc, inox
Cucharón monobloc, inox

art.	l. cm.
11982-38	38



Cucchiaione forato unipezzo, inox
One piece perforated spoon, s/s
Giesslöffel perforiert, fugenlos, Edelstahl
Cuillère perforée monobloc, inox
Cucharón perforado, monobloc, inox

art.	l. cm.
11984-38	38



Cucchiaione obliquo unipezzo, inox
One piece spoon, crosswise, s/s
Giesslöffel quer, fugenlos, Edelstahl
Cuillère oblique monobloc, inox
Cucharón obliquo monobloc, inox

art.	l. cm.
11983-38	38

UTENSILI KITCHEN UTENSILS



NSF

Cucchiaione per mancini, inox
Spoon, left handed, stainless steel
Giesslöffel für Linkshänder, Edelstahl
Cuillère gaucher, inox
Cucharón para zurdos, inox

art.	l. cm.
11983-37	38



NSF

Forchettone 3 denti unipezzo, inox
One piece meat fork, 3 prongs, s/s
Fleischgabel 3 Zacken, fugentos, E. R.
Fourchette 3 dents, monobloc, inox
Tenedor 3 dientes, monobloc, inox

art.	l. cm.
11974-50	50
11974-70	70



NSF

Forchettone 2 denti unipezzo, inox
One piece meat fork, 2 prongs, s/s
Fleischgabel 2 Zacken, fugentos, E. R.
Fourchette 2 dents, monobloc, inox
Tenedor 2 dientes, monobloc, inox

art.	l. cm.
11975-50	50
11975-99	100



NSF

Paletta liscia unipezzo, inox
One piece spatula, stainless steel
Backschaufel, fugentos, Edelstahl
Spatule monobloc, inox
Espátula lisa monobloc, inox

art.	cm.	l.
11972-10	10	36
11972-12	12	39



NSF

Paletta forata unipezzo, inox
One piece perforated spatula, s/s
Backschaufel perforiert, fugentos, E. R.
Spatule perforée monobloc, inox
Espátula perforada monobloc, inox

art.	cm.	l.
11973-10	10	36
11973-12	12	39



NSF

Pala a ridurre, inox
Perforated slice, stainless steel
Reduzierspatel, Edelstahl Rostfrei
Spatule à réduire, inox
Espátula para reducir, inox

art.	cm.	l.
11976-50	12x15	50
11976-99	12x15	100



NSF

Paletta pesce unipezzo, forata, inox
One piece fish spatula, stainless steel
Fischheber, fugentos, Edelstahl Rostfrei
Pelle à poisson monobloc, inox
Espátula para pescado, monobloc, inox

art.	l. cm.
11985-34	34



NSF

Schiumarola unipezzo, inox
One piece skimmer, stainless steel
Schaumlöffel, fugentos, Edelstahl
Ecumoire monobloc, inox
Espumadera monobloc, inox

art.	ø cm.	l.
11971-08	8	29,0
11971-10	10	32,0
11971-12	12	35,0
11971-14	14	38,0
11971-16	16	41,0
11971-18	18	42,5
11971-20	20	44,5
11971-25*	25	75,0

*Manico a tubo. - Tube handle.



NSF

Mestolo unipezzo, inox
One piece ladle, stainless steel
Schöpflöffel, fugentos, Edelstahl Rostfrei
Louche monobloc, inox
Cacillo monobloc, acero inox

art.	ø cm.	l.	lt.
11970-01	8	23	0,12

Manico corto. - Short handle.



NSF

Mestolo con becco a versare, inox
Side basting spoon, stainless steel
Saucenkelle mit seitlichem Ausguß, E. R.
Cuillère à arroser, inox
Cacillo para versar, inox

art.	ø cm.	l.	lt.
11969-02	6,5	23	0,07



NSF

Cucchiaione unipezzo, inox
One piece spoon, stainless steel
Giesslöffel, fugentos, Edelstahl Rostfrei
Cuillère monobloc, inox
Cuchara monobloc, inox

art.	l. cm.
11982-01	23,5



NSF

Forchettone unipezzo, inox
One piece meat fork, stainless steel
Fleischgabel, fugentos, Edelstahl
Fourchette monobloc, inox
Tenedor monobloc, inox

art.	l. cm.
11975-01	26

Manico corto. - Short handle.



Paletta forata unipezzo, inox
One piece perforated spatula, s/s
Backschaufel perforiert, fugenlos, E. R.
Spatule perforée monobloc, inox
Espátula perforada monobloc, inox

art.	cm.	l.
11973-01	8x9,5	24

Manico corto. - Short handle.



Schiumarola unipezzo, inox
One piece skimmer, stainless steel
Schaumlöffel, fugenlos, Edelstahl
Ecumoire monobloc, inox
Espumadera monobloc, inox

art.	ø cm.	l.
11971-01	9	26



Asta, inox
Wall rack, stainless steel
Aufhängungstange, Edelstahl Rostfrei
Tringle de cuisine, inox
Asta para utensilios, inox

art.	l. cm.
41670-AA	40
41670-AB	60



Mestolo, inox
Ladle, stainless steel
Schöpflöffel, Edelstahl Rostfrei
Louche, inox
Cacillo, inox

art.	ø cm.	l.	lt.
41670-06	6	30	0,03
41670-09	9	32	0,13



Schiumarola, inox
Skimmer, stainless steel
Schaumlöffel, Edelstahl Rostfrei
Ecumoire, inox
Espumadera, inox

art.	ø cm.	l.
41671-11	11	32



Paletta forata, inox
Slotted turner, stainless steel
Küchenwender, geschlitzt, Edelstahl
Pelle ajourée, inox
Espátula perforada, inox

art.	l. cm.
41672-00	32



Cucchiaio per spaghetti, inox
Spaghetti spoon, stainless steel
Spaghettilöffel, Edelstahl Rostfrei
Cuillère à spaghetti, inox
Tenedor espaguetitis, inox

art.	l. cm.
41673-00	32



Forchettone, inox
Meat fork, stainless steel
Fleischgabel, Edelstahl Rostfrei
Fourchette, inox
Tenedor, inox

art.	l. cm.
41674-00	32



Cucchiaione, inox
Basting spoon, stainless steel
Giesslöffel, Edelstahl Rostfrei
Cuillère, inox
Cuchara, inox

art.	l. cm.
41675-00	32



Cucchiaione forato, inox
Perforated spoon, stainless steel
Schöpfkelle, gelocht, Edelstahl Rostfrei
Cuillère percée, inox
Cuchara perforada, inox

art.	l. cm.
41676-00	32



Cucchiaione salse, inox
Sauce ladle, stainless steel
Saucenkelle, Edelstahl Rostfrei
Cuillère à sauce, inox
Cuchara salsas, inox

art.	l. cm.
41677-00	32

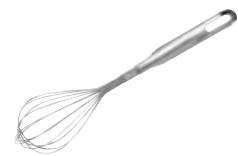

Frusta, inox
Whisk, stainless steel
Schneebeesen, Edelstahl Rostfrei
Fouet, inox
Batidor, inox

art.	l. cm.
41678-00	30

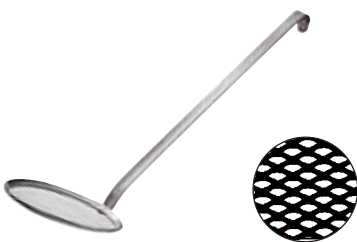

Schiumarola a rete stirata, inox
Mesh skimmer, stainless steel
Schaumlöffel, Edelstahl Rostfrei
Ecumoire, inox
Espumadera, inox

art.	ø cm.	l.
11990-16	16	40



Schiumarola a rete passabrodo, inox
Mesh skimmer, stainless steel
Schaumlöffel, Edelstahl Rostfrei
Ecumoire, inox
Espumadera, inox

art.	ø cm.	l.
11991-16	16	40



Colafritto, inox
Bird nest fryer, stainless steel
Nestbacklöffel, Edelstahl Rostfrei
Nid à friture, inox
Molde nido, inox

art.	ø cm.	l.
42623-10	10	26

UTENSILI KITCHEN UTENSILS



Schiumarola a filo inox
Skimmer, stainless steel
Drahtlöffel, Edelstahl Rostfrei
Ecuimoire, inox
Espumadera a filo, inox

art.	ø cm.	l.
12640-14	14	40
12640-16	16	40
12640-18	18	40
12640-20	20	50
12640-24	24	50
12640-28	28	50

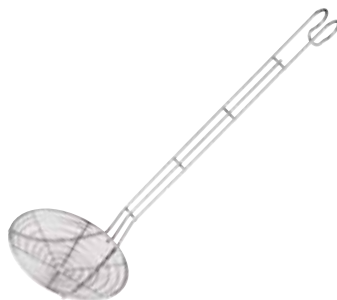

Schiumarola a filo inox
Skimmer, stainless steel
Drahtlöffel, Edelstahl Rostfrei
Ecuimoire, inox
Espumadera a filo, inox

art.	ø cm.	l.
12641-14	14	40
12641-16	16	40
12641-18	18	40
12641-20	20	50
12641-24	24	50
12641-28	28	50



Schiumarola fish & chips, inox
Skimmer fish & chips, stainless steel
Fritierschaumlöffel, Edelstahl Rostfrei
Ecuimoire, inox
Espumadera para pescado, inox

art.	ø cm.	l.
12642-28	28	85

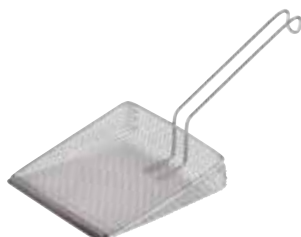

Paletta patatine, inox
Chips shovel, stainless steel
Frittenschaufel, Edelstahl Rostfrei
Pelle à pommes-frites, inox
Pala chips, inox

art.	dim. cm.	l.
42642-20	21x17	21



Pala per patate fritte, inox
French fry scoop, stainless steel
Frittenschaufel, Edelstahl Rostfrei
Pelle à frites, inox
Pala chips, inox

art.	dim. cm.
41929-00	20x23



Spatola legno
Wood spatula
Holzschäber
Spatule en bois
Espátula de madera

art.	l. cm.
42907-30	30
42907-35	35
42907-40	40



Spatola legno
Wood spatula
Holzschäber
Spatule en bois
Espátula de madera

art.	l. cm.
42907-01	25
42907-02	30
42907-03	35
42907-04	40
42907-06	50
42907-07	60
42907-08	80
42907-09	100
42907-10	120



Cucchiaine legno
Wood mixing spoon
Holzlöffel
Cuillère en bois
Cuchara de madera

art.	l. cm.
42901-20	20
42901-25	25
42901-30	30
42901-35	35
42901-40	40



Spatole crêpes, legno
Crepe spreader, beachwood
Crêpe-Paletten, Holz
Rateau à crêpes/raclettes, hêtre
Espátula crêpes, madera

art.	dim. cm.	u.pack
42900-15	18x18	5
42900-24	18x24	5



Pinza togli lische, inox
Fish-bone remover, stainless steel
Grätenentkerner, Edelstahl Rostfrei
Pince à arêtes, inox
Pinza para espinas

art. l. cm.
42592-01 lische fini/thin bones
42592-02 lische grosse/thick bones



Pompetta per sugo, inox
Baster tube, stainless steel
Saft-Spritze, Edelstahl Rostfrei
Pompe à jus, inox
Bomba para jugo, inox

art. l. cm.
42863-00 20



Pinza per grill, inox
Sausage tongs, stainless steel
Grill- und Würstzange, Edelstahl Rostfrei
Pince à saucisses, inox
Pinza para barbacoa, inox

art. l. cm.
41697-00 38



Pinza, inox
Cooking tong, stainless steel
Kochzange, Edelstahl Rostfrei
Pince, inox
Pinza, inox

art. l. cm.
42904-01 16



Pinza, inox
Cooking tong, stainless steel
Kochzange, Edelstahl Rostfrei
Pince, inox
Pinza, inox

art. l. cm.
42904-02 16



Pinza, inox
Cooking tong, stainless steel
Kochzange, Edelstahl Rostfrei
Pince, inox
Pinza, inox

art. l. cm.
42904-03 15

Ideali per impiattare cibi delicati, la preparazione e decorazione di piatti. - Ideal for lifting and turning soft food and to decorate dishes.



Pinza, inox
Cooking tong, stainless steel
Kochzange, Edelstahl Rostfrei
Pince, inox
Pinza, inox

art. l. cm.
42902-31 30



Pinza, inox
Cooking tong, stainless steel
Kochzange, Edelstahl Rostfrei
Pince, inox
Pinza, inox

art. l. cm.
42902-30 30



Molla per grill, inox
Grill tweezer, stainless steel
Grillzange, Edelstahl Rostfrei
Pince à grille, inox
Pinza para barbacoa, inox

art. l. cm.
41698-22 22,5
41698-30 30,0
41698-40 40,0



Pinza a servire, inox
Serving tong, stainless steel
Servierzange, Edelstahl
Pince à servir, inox
Pinza para servir, inox

art. l. cm.
42854C25 25
42854C30 30



Pinza a servire, inox
Serving tong, stainless steel
Servierzange, Edelstahl
Pince à servir, inox
Pinza para servir, inox

art. l. cm.
42854B25 25
42854B30 30



Pinza a servire, inox
Serving tong, stainless steel
Servierzange, Edelstahl
Pince à servir, inox
Pinza para servir, inox

art. l. cm.
42854Y25 25
42854Y30 30

UTENSILI KITCHEN UTENSILS



Pinza a servire, inox
Serving tong, stainless steel
Servierzange, Edelstahl
Pince à servir, inox
Pinza para servir, inox

art.	l. cm.
42854K25	25
42854K30	30



Pinza a servire, inox
Serving tong, stainless steel
Servierzange, Edelstahl
Pince à servir, inox
Pinza para servir, inox

art.	l. cm.
42854R25	25
42854R30	30



Pinza a servire, inox
Serving tong, stainless steel
Servierzange, Edelstahl
Pince à servir, inox
Pinza para servir, inox

art.	l. cm.
42854G25	25
42854G30	30



Spazzola grill
Barbecue brush
Grill-Bürste
Brosse à grille
Cepillo para barbacoa

art.	dim. cm.	l.
41773-00	5,5x11	27



Pinza, silicone
Cooking tong, silicone
Kochzange aus Silikon
Pince en silicone
Pinza de silicona

art.	l. cm.
42903-29	29

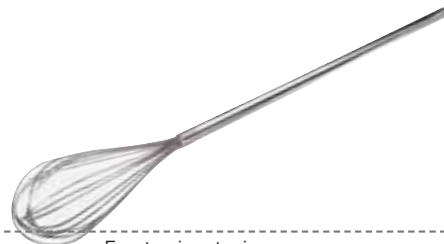

Frusta gigante, inox
Whisk for basin, stainless steel
Kesselbesen, Edelstahl Rostfrei
Fouet à bassine, inox
Batidor gigante, inox

art.	l. cm.
41980-99	125

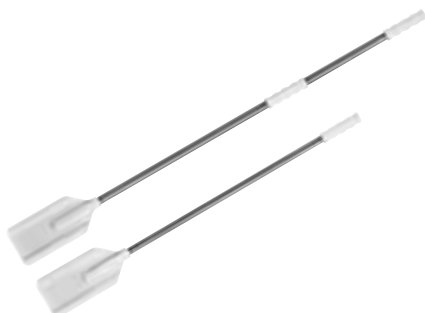

Spatola in resina alimentare
Food spatula
Rührspaten für Speisenzubereitung
Spatule pour aliments
Espátula

art.	dim. cm.	l.
44061-08	15,7x10,8	80
44061-09	23,5x10,8	90
44061-12	23,5x10,8	117
44061-14	23,5x10,8	137



Rastrelliera, inox
Speed rack, stainless steel
Flaschenregal, Edelstahl Rostfrei
Rack à bouteilles, inox
Rack de botellas, inox

art.	dim. cm.	h.	bot.
44060-50	56x10,5	15,5	6
44060-80	81x10,5	15,5	8



Spillone portascontrini, inox
Hat pin for tickets, stainless steel
Kassenscheine-Aufstecknadel, Edelstahl
Epingle porte-tickets, inox
Pinchanotas, inox

art.	ø cm.	h.
12504-20	9	20



Spillone portascontrini, legno
Hat pin for tickets, wood
Kassenscheine-Aufstecknadel, Holz
Epingle porte-tickets, bois
Pinchanotas, madera

art.	dim. cm.	h. cm.
42504-09	9x5,5	10,5
42504-20	20x5,5	10,5



Asta portascontrini, inox
Tickets-holder, stainless steel
Bons-halter, Edelstahl Rostfrei
Porte-fiches à billes, inox
Barra de notas, inox

art.	l. cm.
42509-25	25
42509-50	50



Asta porta scontrini, inox
Tab-grabber, stainless steel
Bons-Halter, Edelstahl Rostfrei
Porte-fiches, inox
Barra de notas, inox

art.	l. cm.
42509-60	60
42509-99	100



Porta rotolo, inox
Roll holder, stainless steel
Rollenhalter, Edelstahl Rostfrei
Derouleur papier, inox
Portarollos, inox

art.	l cm.
42512-35	30



Supporto murale, porta pellicola, inox
Film box, stainless steel
Folien-Abreißgerät, 18-10 Rostfrei
Dérouteur de film, inox
Soporte de muro para film, inox

art.	l cm.
42513-30	30
42513-45	45



Pellicola per microonde
Transparent film for microwave ovens
Folie für Mikrowelle
Film transparent pour four à micro-ondes
Film transparente para microonda

art.	mt.
47683-30	300



FORNI MICROONDE
Microwave ovens
PAGINA - Page: 155



Piatto pizza, cordierite
Pizza dish, cordierite
Pizza Teller, Cordierit
Plat à pizza, cordiërite
Plato pizza, cordierita

art.	Ø cm.
44310-33	33

Speciale pietra per cucinare pizze (anche surgelate) con il microonde.
Special stone to cook (also frozen) pizzas in microwave oven.



Piatto pesce, cordierite ceramicata
Fish dish, ceramic cordierite
Fisch-Teller
Plat à poisson
Plato pescado

art.	dim. cm.	h.
44311-37	37x16	2,5

Per cucinare il pesce in microonde e su altre fonti di calore. - To cook fish in microwave oven and on other heat sources.



Piatto grigliante, antiaderente
Non-stick grilling plate
Grill-Teller
Plat à grillage
Plato parrilla

art.	Ø cm.	h.
47602-25	25	2,0
47602-27	27	3,5
47602-31	31	3,5

Per forno microonde. Cuoce e dora carni, verdure, pizze, etc. Lavabile in lavastoviglie. - For microwave oven. To cook and brown meat, vegetables, pizza, etc. Dishwasher safe.



Cuoci uovo singolo, PP
Single egg cooker, PP
Eierkocher, PP
Cuiseur à oeuf, PP
Caldera para huevo, PP

art.	Ø cm.	h.
47602-01	7	9

Per forno microonde. Minicoperchio con 4 fori per la fuoriuscita del vapore. Lavabile in lavastoviglie. - For microwave oven. Mini lid with 4 holes. Dishwasher safe.



Cuoci uovo doppio, PC
Double egg cooker, PC
Eierkocher, PC
Cuiseur à oeufs, PC
Caldera para huevos, PC

art.	dim. cm.	h.
47602-02	20,5x12	4

Per forno microonde. 2 scomparti per la cottura di uova in camicia. Lavabile in lavastoviglie. - For microwave oven. Dishwasher safe.



Cuoci omelette, PP
Omelette cooking dish, PP
Omelette Backform, PP
Cuiseur à omelettes, PP
Plato para cocinar tortillas, PP

art.	dim. cm.	h.
47602-04	22,5x15	5,5

Per cucinare l'omelette in microonde, lavabile in lavastoviglie. - For cooking omelettes in microwave oven. Dishwasher safe.



Cuocivapore set 3 pz, PC
Steamer 3 pcs set, PC
Dampf-Koch-Satz, PC
Kit cuisson à vapeur, PC
Juego para cocción al vapor, PC

art.	Ø cm.	h.
47602-03	25	8

Per microonde, lavabile in lavastoviglie. For microwave oven. Dishwasher safe.



Anello distanziatore, PP
Additional plate stand, PP
Gestell für Zusatzteller, PP
Support assiette supplémentaire, PP
Soporte distanciador, PP

art.	Ø cm.	h.
47605-23	19-21	6

Per microonde. - Microwave safe.



Copripiatto per microonde, PP
Microwave plate cover, PP
Tellerglocke für Mikrowelle, PP
Cloche pour four à micro-ondes, PP
Cubreplatos para microonda, PP

art.	Ø cm.
47603-27	27

Impilabile, lavabile in lavastoviglie.
Stackable, dishwasher safe.



Copripiatto per microonde, PP
Microwave plate cover, PP
Tellerglocke für Mikrowelle, PP
Cloche pour four à micro-ondes, PP
Cubreplatos para microonda, PP

art.	Ø cm.	h.
47601-26	27	6



Copripiatto per microonde, PP
Microwave plate cover, PP
Tellerglocke für Mikrowelle, PP
Cloche pour four à micro-ondes, PP
Cubreplatos para microonda, PP

art.	Ø cm.	h.
44998-31	31	6,5

Impilabile, lavabile in lavastoviglie.
Stackable, dishwasher safe.



Copripiatto, policarbonato
Plate cover, polycarbonate
Tellerglocke, Polykarbonat
Cloche, polycarbonate
Cubreplatos, PC

art.	Ø cm.	h.
44997-22	22	6,8
44997-24	24	6,8
44997-26	26	6,8
44997-28	28	6,8



Copripiatto, inox
Plate cover, stainless steel
Tellerglocke, Edelstahl Rostfrei
Cloche, inox
Cubreplatos, inox

art.	Ø cm.	h.
41683-26	26,5	4,3



Imbuto, polipropilene
Funnel, PP
Trichter, PP
Entonnoir, PP
Embudo, PP

art.	Ø cm.
47604-08	8
47604-10	10
47604-12	12
47604-15	15
47604-18	18
47604-20	20
47604-24	24
47604-30	30



Imbuto, inox
Funnel, stainless steel
Trichter, Edelstahl Rostfrei
Entonnoir, inox
Embudo, inox

art.	Ø cm.
42562-12	12
42562-14	14
42562-16	16
42562-18	18
42562-20	20
42562-25	25
42562-30	30



Caraffa graduata, PP
Measuring jug, PP
Messbecher, PP
Récipient-mesure, PP
Jarra de medidas, PP

art.	Ø cm.	h.	lt.
47606-02	8,5	10,0	0,25
47606-05	10,5	10,5	0,50
47606-10	12,5	14,5	1,00
47606-20	13,5	17,0	2,00
47606-30	15,5	21,0	3,00
47606-50	19,0	24,0	5,00



Caraffa graduata, impilabile, PP
Measuring jug, stackable, PP
Messbecher, stapelbar, PP
Récipient-mesure, empilable, PP
Jarra de medidas apilable, PP

art.	Ø cm.	h.	lt.
47607-10	12,5	14,5	1
47607-20	13,5	17,0	2



Misurino graduato, impilabile, inox
Graduated measure jug, stackable, s/s
Messbecher, graduiert, stapelbar, E. R.
Mesure graduée, empilable, inox
Jarra de medidas apilable, inox

art.	ø cm.	h.	lt.
42581-01	7,5	5	0,1
42581-03	10,0	7	0,3
42581-05	11,5	11	0,5
42581-10	15,0	13	1,0
42581-15	15,5	15	1,5
42581-20	17,0	19	2,0



Misurini, inox
Measuring cups/spoons, stainless steel
Maßbecher-/löffel, Edelstahl Rostfrei
Mesures, inox
Juego 4 cazos de medidas, inox

art.	ml.
42615-04	1-2,5-5-15



Misurini, inox
Measuring cups/spoons, stainless steel
Maßbecher-/löffel, Edelstahl Rostfrei
Mesures, inox
Juego 4 cazos de medidas, inox

art.	ml.
42616-04	60-80-125-250



Sessola tonda, inox
Flour scoop, stainless steel
Mehlschaufel, Edelstahl Rostfrei
Pelle à farine, inox
Librador, inox

art.	lt.
42609-10	0,1
42609-15	0,4
42609-20	1,0
42609-23	1,7
42609-25	2,8



Sessola, PP
Flour scoop, PP
Mehlschaufel, PP
Pelle à farine, PP
Librador, PP

art.	dim. cm.	lt.
17610-01	20x7	0,10
17610-02	27,5x9,5	0,25
17610-05	32,5x12	0,50
17610-10	39x15	1,00



Sessola
Flour scoop
Mehlschaufel
Pelle à farine
Librador

art.	dim. cm.	lt.
12940-02	27,5x9,5	0,25
12940-05	32,5x12	0,50
12940-10	39x15	1,00
12940-20	48x18	2,00
12940-25	50x19,5	2,50



Setaccio rete intercambiabile, inox
Sieve with spare gauzes, stainless steel
Sieb mit auswechselbarem Siebeinsatz
Tamis avec toiles de rechange, inox
Cernidor con red intercambiable, inox

art.	ø cm.	rete/mesh
42590-01	30	1,4 mm
42590-02	30	1,1 mm
42590-03	30	0,9 mm
42591-02	40	1,1 mm
42591-03	40	0,9 mm



Rete intercambiabile, inox
Spare gauzes, stainless steel
Auswechselbarem Siebeinsatz
Toiles de rechange, inox
Red intercambiable, inox

art.	ø cm.	rete/mesh
42590R01	30	1,4 mm
42590R02	30	1,1 mm
42590R03	30	0,9 mm
42591R02	40	1,1 mm
42591R03	40	0,9 mm



Setaccio pane, inox
Bread sieve, stainless steel
Brotsieb, Edelstahl Rostfrei
Tamis à pain, inox
Cernidor para pan, inox

art.	ø cm.	h.
12604-22	22	8
12604-30	30	8
12604-34	34	8
12604-40	40	8



Numero dei fori per 2,5 cm².
 Eye per inch.

UTENSILI KITCHEN UTENSILS



Setaccio farina, inox
Flour sieve, stainless steel
Mehlsieb, Edelstahl Rostfrei
Tamis à farine, inox
Cernidor para harina, inox

art.	ø cm.	h.
12605-22	22	8
12605-30	30	8
12605-34	34	8
12605-40	40	8

20

Numero dei fori per 2,5 cm².
 Eye per inch.



Setaccio infarina pesce, inox
Sieve, stainless steel
Sieb, Edelstahl Rostfrei
Tamis, inox
Cernidor, inox

art.	ø cm.	h.
12606-30	30	8
12606-34	34	8

4

Numero dei fori per 2,5 cm².
 Eye per inch.



Setaccio rete pasticciare, inox
Sieve, stainless steel
Sieb, Edelstahl Rostfrei
Tamis, inox
Cernidor, inox

art.	ø cm.	h.
12607-22	22	8
12607-30	30	8
12607-34	34	8

10

Numero dei fori per 2,5 cm².
 Eye per inch.



Bacinella conica con maniglie, inox
Kitchenbowl, with handles, s/s
Schüssel mit Griffen, Edelstahl Rostfrei
Bassine conique avec anses, inox
Caldero cónico con asas, inox

art.	ø cm.	h.	lt.
11955-32	32	16,0	8,8
11955-36	36	18,5	12,8
11955-40	40	20,0	17,0
11955-45	45	22,5	24,5
11955-50	50	24,0	32,5



Colapasta tronco conico, inox
Conical colander, stainless steel
Gemüseseiher, Edelstahl Rostfrei
Passoire à légumes, inox
Colador cónico, inox

art.	ø cm.	h.	lt.
11930-24	24	12,0	3,5
11930-28	28	14,0	5,5
11930-32	32	16,0	8,8
11930-36	36	18,5	12,8
11930-40	40	20,0	17,0
11930-45	45	22,5	24,5
11930-50	50	24,0	32,5



Colapasta tronco conico, inox
Conical colander, stainless steel
Gemüseseiher, Edelstahl Rostfrei
Passoire à légumes, inox
Colador cónico, inox

art.	ø cm.	h.	lt.
11927-24	24	12,0	3,5
11927-28	28	14,0	5,5
11927-32	32	16,0	8,8
11927-36	36	18,5	12,8
11927-40	40	20,0	17,0
11927-45	45	22,5	24,5
11927-50	50	24,0	32,5



Bacinella semisferica, inox
Hemispherical mixing bowl, s/s
Schüssel, Edelstahl Rostfrei
Bassine demi-ronde, inox
Caldero semiesférico, inox

art.	ø cm.	lt.
11957-20	20	2,0
11957-25	25	3,7
11957-30	30	7,2
11957-35	35	10,5
11957-40	40	15,6



NSF

Bacinella conica bassa, inox
Kitchenbowl low, stainless steel
Schüssel, flach, Edelstahl Rostfrei
Bassine, inox
Caldero cónico, inox

art.	ø cm.	h.	lt.
12582-13	13,2	6,0	0,5
12582-17	16,5	7,5	1,0
12582-22	22,0	7,5	2,0
12582-24	24,0	9,5	3,0
12582-32	30,5	11,5	6,0
12582-34	32,5	14,0	8,0
12582-38	38,0	13,5	11,0
12582-40	40,0	15,0	14,0



NSF

Bacinella conica alta, inox
Kitchenbowl high, stainless steel
Tiefe Schüssel, Edelstahl Rostfrei
Bassine haute, inox
Caldero cónico alto, inox

art.	ø cm.	h.	lt.
12580-11	11,7	7,0	0,5
12580-17	15,5	9,0	1,0
12580-21	19,0	11,5	2,0
12580-24	22,0	12,0	3,0
12580-29	27,0	13,5	5,0
12580-30	29,0	15,0	6,0
12580-31	30,5	17,0	8,0
12580-36	35,5	18,5	11,0
12580-40	40,0	20,0	17,0
12580-45	45,0	22,0	25,0
12580-50	50,0	24,0	33,0



Colatutto tronco conico
Conical colander
Gemüsesieher
Passoire à légumes
Colador cónico



art.	ø cm.	h.	lt.
12950-32	32	16	8
12950-40	40	20	12



Colapasta tronco conico, alluminio
Conical colander, aluminium
Gemüsesieher, Aluminium
Passoire à légumes, alu
Colador cónico, aluminio

art.	ø cm.	h.	lt.
16927-32	32	16,0	8,8
16927-36	36	18,5	12,8
16927-40	40	20,0	17,0
16927-45	45	22,5	24,5
16927-50	50	24,0	32,5



Colapasta con cerchio, inox
Colander, stainless steel
Gemüsesieher, Edelstahl Rostfrei
Passoire à légumes, inox
Colador con base, inox

art.	ø cm.	h.	lt.
11928-32	32	18	9,5
11928-36	36	19	12,0
11928-40	40	21	14,5



Colapasta semisferico, inox
Strainer, stainless steel
Stielsieb, Edelstahl Rostfrei
Passoire hémisphérique, inox
Colador semiesférico, inox

art.	ø cm.	h.	lt.
11926-22	22	12	2,7
11926-26	26	14	4,0



Colapasta, inox
Strainer, stainless steel
Stielsieb, Edelstahl Rostfrei
Passoire, inox
Colador, inox

art.	ø cm.	h.	lt.
11924-18	18	11	2,8
11924-20	20	12	3,6
11924-22	22	13	5,0
11924-24	24	14	6,5
11924-28	28	15	9,3



Colapasta, alluminio
Strainer, aluminium
Stielsieb, Aluminium
Passoire, alu
Colador, aluminio

art.	ø cm.	h.	lt.
16924-20	20	11	3,2
16924-24	24	13	6,0
16924-28	28	15	9,3



Colapasta, PP
Strainer, PP
Stielsieb, PP
Passoire, PP
Colador, PP

art.	ø cm.
47610-22	22
47610-26	26
47610-30	30



Colapasta, PP
Strainer, PP
Stielsieb, PP
Passoire, PP
Colador, PP

art.	ø cm.
47610-18	18



Secchio graduato, plastica
Graduated bucket, plastic
Eimer mit Skala, Plastik
Seau gradué, plastique
Cubo plástico

art.	ø cm.	lt.
49889-15*	32	15
49889-18*	33	18
49889-21*	35	21
49889-30	39	30

* Con becco. - With spout.

UTENSILI KITCHEN UTENSILS



Secchiello graduato, inox
Graduated bucket, stainless steel
Eimer mit Skala, Edelstahl Rostfrei
Seau gradué, inox
Cubo con medidas, inox

art.	ø cm.	h.	lt.
41960-08	28,5	20,5	8
41960-10	30,0	25,0	10
41960-12	31,0	27,0	12
41960-15	32,5	31,0	15



Secchiello graduato con base, inox
Graduated bucket with bottom ring, s/s
Eimer mit Fuss u. Skala, Edelstahl
Seau gradué avec base, inox
Cubo con medidas y base, inox

art.	ø cm.	h.	lt.
41961-10	30,0	26,5	10
41961-12	31,0	28,5	12
41961-15	32,5	32,5	15



Coperchio per secchiello, inox
Lid for bucket, stainless steel
Deckel für Eimer, Edelstahl Rostfrei
Couvercle pour seau, inox
Tapa para cubo, inox

art.	ø cm.
41962-10	30,0
41962-12	31,0
41962-15	32,5



Bacinella tonda, PE
Mixing bowl, PE
Schüssel, PE
Bassine ronde, PE
Caldero semiesférico, PE

art.	ø cm.	h.	lt.
47600-16	16	7,0	0,9
47600-20	20	8,5	1,6
47600-24	24	10,0	2,8
47600-28	28	11,0	4,5
47600-32	32	12,5	6,5
47600-36	36	14,0	10,0
47600-40	40	15,5	13,5



Bacinella tonda, PP
Mixing bowl, polypropylene
Schüssel, Polypropylen
Bassine ronde, polypropylène
Caldero semiesférico, PP

art.	ø cm.	h.	lt.
47611-01	19,0	7,9	1,0
47611-03	24,0	11,5	2,5
47611-05	28,0	13,5	4,5
47611-06	32,5	14,7	6,0
47611-09	36,0	16,5	9,0
47611-13	40,0	18,5	13,0



Bastardella senza maniglie, inox
Mixing bowl without handles, s/s
Schnees Schlagkessel ohne Griffe, E. R.
Bassine hémisphérique sans anses, inox
Caldero sin asas, inox

art.	ø cm.	h.	lt.
11951-22	22	12,0	2,7
11951-26	26	14,0	4,0
11951-32	32	18,0	9,5
11951-36	36	20,5	14,0
11951-40	40	21,5	18,0



Bastardella semisferica, inox
Mixing bowl, stainless steel
Schnees Schlagkessel, Edelstahl Rostfrei
Bassine hémisphérique, inox
Caldero con asas, inox

art.	ø cm.	h.	lt.
11952-22	22	12,0	2,7
11952-26	26	14,0	4,0
11952-32	32	18,0	9,5
11952-36	36	20,5	14,0
11952-40	40	21,5	18,0



Base per bastardella, inox
Foot for mixing bowl, stainless steel
Fuss für Schnees Schlagkessel, Edelstahl
Base pour bassine hémisphérique, inox
Base para caldero, inox

art.	ø cm.	per/for ø
11953-16	16	22-26



Base per bastardella, inox
Foot for mixing bowl, stainless steel
Fuss für Schnees Schlagkessel, Edelstahl
Base pour bassine hémisphérique, inox
Base para caldero, inox

art.	ø cm.	per/for ø
11953-22	22	32-36-40



Bacinella per planetaria, inox
Kettle for mixing machines, s/s
Schlagmaschinenkessel, Edelstahl
Bol pour mélangeurs, inox
Caldero para batidera, inox

art.	ø cm.	h.	lt.
11954-26	26	20,0	10
11954-30	30	25,0	16
11954-32	32	30,0	20
11954-36	36	28,5	25
11954-37	36	35,0	32
11954-40	40	35,5	40



Tazzone con manico e gancio, inox
Kitchenbowl with handle and hook, s/s
Schlagschüssel mit Rohrstiel u. Haken
Bol avec manche et crochet, inox
Cazo bombeado con gancho, inox

art.	ø cm.	h.	lt.
41916-10	15	8	1,0
41916-15	17	9	1,2
41916-20	19	10	2,0



Centrifuga manuale per verdura
Manual salad spinner
Salatschleuder
Essoreuse manuelle à salade
Secador manual para verduras

art.	ø cm.	h.	lt.
49888-10	33	43	12
49888-20	43	52	25



Colino a rete, inox
Soup strainer, stainless steel
Suppensieb, Edelstahl Rostfrei
Passe-bouillon, inox
Colador a red, inox

art.	ø cm.	l.
12622-07	7	12
12622-10	10	12
12622-12	12	17
12622-14	14	17
12622-16	16	17
12622-18	18	17
12622-20	20	17
12622-23	23	27
12622-26	26	27



Colapasta doppia rete, inox
Strainer, double mesh, stainless steel
Passiersieb, doppelnetz, Edelstahl
Passoire, maille double, inox
Colador doble red inox

art.	ø cm.	l.
12633-16	16	17
12633-18	18	17
12633-20	20	17
12633-23	23	27
12633-26	26	27



Colatutto, inox
Strainer, stainless steel
Sieb, Edelstahl Rostfrei
Passoire, inox
Colador multiuso, inox

art.	dim. cm.	l.
12630-22	22x18	19



Colapasta rinforzato, inox
Strainer, reinforced, stainless steel
Grossküchensieb mit Verstärkung, E. R.
Passoire renforcé, inox
Colador reforzado, red inox

art.	ø cm.	l.
12635-23	23	27
12635-26	26	27
12635-30	30	44
12635-35	35	44



Passaverdura, inox
Vegetable sieve, stainless steel
Passiergerät, Edelstahl Rostfrei
Mini hache-tout, inox
Pasa verdura, inox

art.	ø cm.
12638-20	20



Colatutto gigante, inox
Strainer, stainless steel
Grossküchensieb, Edelstahl Rostfrei
Passoire étamé, inox
Colador multiuso gigante, inox

art.	ø cm.	l.
12636-32	32	60

UTENSILI KITCHEN UTENSILS



Cornetto cinese, inox
Chinese colander, stainless steel
Spitzsieb, Edelstahl Rostfrei
Passoire chinois, inox
Colador chino, inox

art.	Ø cm.
41925-14	14
41925-16	16
41925-18	18
41925-20	20
41925-22	22
41925-24	24
41925-26	26



Supporto per cornetto cinese, inox
Chinese colander stand, stainless steel
Träger für Spitzsieb, Edelstahl Rostfrei
Support chinois, inox
Soporte para colador chino, inox

art.	Ø cm.	h.
41933-18	18	28



Cornetto cinese a rete, inox
Colander with wire gauze, stainless steel
Gazensieb, Edelstahl Rostfrei
Chinois à gaze, inox
Colador chino a red, inox

art.	Ø cm.
11929-20	20
11929-24	24



Cornetto c/protezione, inox
Chinese colander with wire protection, s/s
Spitzsieb mit Verstärkung, Edelstahl
Chinois à gaze avec renfort, inox
Colador chino con protección, inox

art.	Ø cm.
11932-20	20
11932-24	24



Colino conico a rete, inox
Chinese soup strainer, stainless steel
Suppen-Spitzsieb, Edelstahl Rostfrei
Passe-bouillon chinois, inox
Colador cónico a red, inox

art.	Ø cm.
41931-08	8
41931-14	14
41931-16	16
41931-18	18



Panno passabrodo
Bouillon cloth
Bouillonstoffsieb
Etamine passe-bouillon
Paño para pasar caldo

art.	dim. cm.	u.pack
41932-05	87x70	5

Tela di cotone ritorto, orlata. - *Twisted cotton cloth with seam.*



Porzionatore, ABS
Rice scoop, ABS
Reis-Portionierer, ABS
Portionneur, ABS
Porcionador de arroz, ABS

art.	gr.	h.
42653-04	120-130	4,5



Presse canard, bronzo
Presse canard, bronze
Presse canard, Bronze
Presse à canard, bronze
Presador para canard, bronce

art.	h. cm.	kg.
49845-01	52	16

Le parti in contatto con gli alimenti sono stagnate. - *Parts in contact with food are tinned.*



PA+
plus

Anello per impiattare
Portion ring
Portionierspeisering
Cercle portionneur
Anillo porcionador

art.	ø cm.	h.
12943-03	3	3,5
12943-05	5	3,5
12943-07	7	3,5
12943-08	8	3,5
12943-10	10	3,5
12943-12	12	3,5



PA+
plus

Anello per impiattare
Portion ring
Portionierspeisering
Cercle portionneur
Anillo porcionador

art.	ø cm.	h.
12944-03	3	3,5
12944-05	5	3,5
12944-07	7	3,5
12944-08	8	3,5
12944-10	10	3,5
12944-12	12	3,5

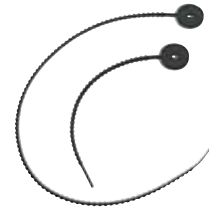

N
P

Laccetti da cucina, silicone, set 6 pezzi
Kitchen strings, silicone, 6 pcs set
Küche-Gurte, Silikon, Satz 6 Stk.
Sangles, silicone, set 6 pcs.
Correas, silicona, juego 6 pz.

art.	l. cm.
51595B44	22
51595B45	53

Laccetto da cucina in alternativa allo spago da cucina. Realizzato in silicone alimentare al 100%. - *Silicone kitchen strings as alternative to twine and rope. Made of 100% food-grade silicone.*



Pressapolipo, inox
Octopus-press, stainless steel
Krake-Presse, Edelstahl Rostfrei
Presse à poulpe, inox
Prensador para pulpo, inox

art.	ø cm.	h.
49760-00	10,5	20,5

Inserendo la polpa di polipo nel Pressapolipo si otterrà un composto uniforme e compatto. Pratico e facilmente affettabile per poter inventare gustosi piatti e decorazioni uniche. *Octopus-press to obtain a compact and uniform compound. Practical and easy to slice to invent tasty plates and sole decoration.*

Dotazione: A - 1 vite con volantino B - 2 chiavi fermadischi C - 2 tubi inox D - 2 dischi inox E - 2 dischi inox con foro.

Equipment: A - 1 screw with handwheel B - 2 spanners to lock the discs C - 2 stainless steel cylinders D - 2 stainless steel discs E - 2 stainless steel discs with hole.



1 - Inserire un dischetto inferiore (non forato) all'interno del cilindro. - *Put a lower disc (without hole) in the cylinder.*



2 - Inserire all'interno del cilindro la polpa di polipo bollito. - *Put some boiled octopus in the cylinder.*



3 - Inserire il dischetto inferiore forato sopra la polpa di polipo. - *Put the upper disc with hole on top of the octopus.*

4 - Inserire la vite facendola combaciare con il foro del dischetto superiore. Pressare la polpa di polipo ruotando in senso orario il volantino. *Insert the screw matching it with the hole of the upper disc. Then press the octopus by rotating in a clockwise direction the handwheel.*

5 - Inserire la chiave fermadischi negli appositi fori. Il composto di polipo è così bloccato tra i due dischetti. Riporre il cilindro nel frigorifero per circa due ore. - *Insert the spanner to lock the disc in the appropriate discs. Now the octopus is locked between the two discs. Put the cylinder in the fridge for about two hours.*

6 - Estrarre il composto ottenuto dal cilindro e affettare a piacimento per gradevoli decorazioni. *Extract the compound obtained by the cylinder and slice as you like to create pleasant decorations.*





Stampi con coperchio, inox
Yule log moulds with cover, stainless steel
Pasteten-Formen mit Deckel, Edelstahl Rostfrei
Gouttières avec couvercle, inox
Moldes para crema con tapa, inox

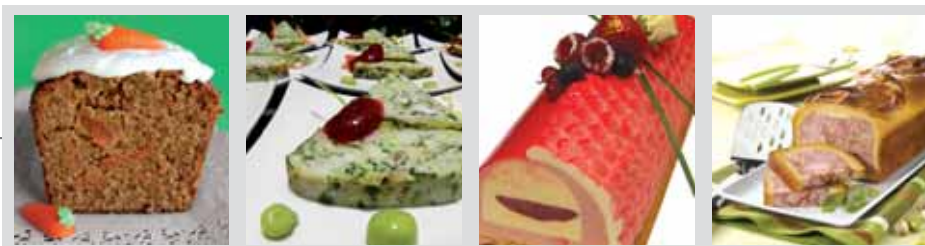

Stampo in acciaio inox finitura lucida, per terrine e dolci. - *Stainless steel mirror polished finish for pastries and terrines.*

	art. item	dim. cm.	l. cm.	lt.
	49762-01	7,5x7	18,0	0,80
	49762-02	7,5x7	23,0	1,00
	49762-03	7,5x7	28,0	1,25
	49762-04	7,5x7	38,0	1,75
	49762-06	5,5x5	27,5	0,50
	49762-10	10x9	50,0	3,50
	49762-05	7-8	30	1,60
	49762-07	8x7,5	26	0,70
	49762-09	10x9	50	2,00
	49762-08	8x7,5	26	0,70



Mini-chitarra, inox
Mini-guitare, stainless steel
Mini-Guitare, Edelstahl Rostfrei
Mini-guitare, inox
Mini guitarra, inox

art.	dim. cm.	h.	kg.
49839-00	45x23	15	4,9

Per prodotti teneri ma di consistenza omogenea. Larghezza taglio 14,5 cm, spessore 5 mm. Lavabile in lavastoviglie. *For products with tender and homogeneous consistency. Cut width 14,5 cm, thickness 5 mm. Dishwasher safe.*



Taglia cubi, inox
Cube cutter, stainless steel
Würfel-Schneidergerät, Edelstahl Rostfrei
Coupe-cubes, inox
Cortador en dados, inox

art.	dim. cm.	h.	kg.
49821-08	39x31	38	4

Spessore taglio 8 mm, disponibile kit da taglio 10 mm. - *Dice thickness 8 mm, available blade assembly dice thickness 10 mm.*



Affetta pomodori, inox
Tomato cutter, stainless steel
Tomatenschneidergerät, Edelstahl Rostfrei
Coupe-tomates, inox
Cortador tomates, inox

art.	dim. cm.	h.	kg.
49837-05	30x14	18	2

Spessore taglio 5,5 mm, lavabile in lavastoviglie. - *Slice thickness 5,5 mm, dishwasher proof.*



Affetta pomodori, ABS - inox
 Tomato cutter, ABS - stainless steel
 Tomatenschneidergerät, ABS - E. R.
 Coupe-tomates, ABS - inox
 Cortador tomates, ABS - inox

art.	dim. cm.	h.	kg.
49837-01	28,5x13	16	0,8

Spessore taglio 5,5 mm, lavabile in lavastoviglie. - Slice thickness 5,5 mm, dishwasher proof.



Taglia verdure manuale, inox
 Manual vegetable cutter, stainless steel
 Gemüseschneider, Edelstahl Rostfrei
 Machine à tourner les légumes, inox
 Cortador de verduras manual, inox

art.	dim. cm.	h.	kg.
49842-00	21x17,5	19	3,2

Per ottenere patate chateau, cocotte e fondenti di lunghezza da cm. 4 a 8 con 7 facce regolari. Lama con 3 regolazioni di taglio. Posizione supporto regolabile. La macchina può essere utilizzata da personale non qualificato. Costruzione in acciaio inox, facile da pulire. Base stabile con 4 piedini a ventosa.

To make easily chateau potatoes, cocottes and fondants with a length from 4 to 8 cm. having 7 regular faces. 3 position adjustable blade. Adjustable position of the carriage support. Can be used by a non qualified personal. Made in stainless steel, easy cleaning. Stability base with 4 suction feet.



Pela carote/verdure
 Long/thin vegetable-peeler
 Gemüeschäler
 Eplucheur à légumes
 Pelador sobre base

art.	dim. cm.	h.	kg.
49819-00	14x17	50	1,9

Fornito con testata pela carote
 Equipped with carrots peeling-head.



Accessori opzionali per pela verdure
 Additional peelingheads
 Schätkopf-Zusatzeile
 Têtes supplémentaires pour eplucheur
 Cabezas suplementarios para pelador

art.	
49819-01	carote/carrots
49819-02	carote grosse/big carrots
49819-03	cetrioli/cucumbers
49819-04	asparagi/asparagus



Pela/svuota ananas, inox
 Pineapple-peeler/corer, stainless steel
 Ananasschälmaschine, Edelstahl
 Epluche-ananas, inox
 Pelador de piña, inox

art.	dim. cm.	h.	kg.
49818-00	45x39	72	18

Lama e pressatore in dotazione ø 89 mm.
 Equipped with blade and pusher ø 89 mm.



Taglia ananas, inox
 Pineapple slicer, stainless steel
 Ananasteiler, Edelstahl Rostfrei
 Coupe-ananas en rondelle, inox
 Cortador de piña en rondajas, inox

art.	l. cm.	ø mm.
48218-00	24	25

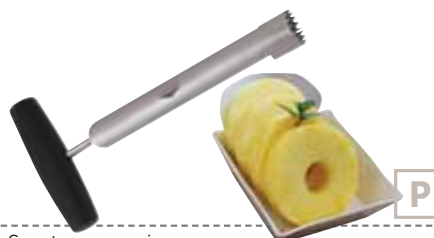

Svuota ananas, inox
 Pineapple coring tool, stainless steel
 Ananasausstecher, Edelstahl Rostfrei
 Vide ananas, inox
 Saca corazón de piña, inox

art.	ø mm.	l. cm.
48280-10	25	24



Pressatori e lame opzionali
 Additional pushers and blades
 Zusätzliche Presse und Messer
 Pousoirs et couteaux supplémentaires
 Empujador y cuchilla suplementarios

art.	ø mm.	
49818-AC	74	lama/blade
49818-AD	74	pressatore/pusher
49818-AE	102	lama/blade
49818-AF	102	pressatore/pusher



8 spicchi, per ortaggi e frutta senza nocciolo. Lavabile in lavastoviglie.
8 wedges, for vegetables and fruits without stone. Dishwasher proof.

Trancia spicchi, inox
Fruit cutter, stainless steel
Früchteschneider, Edelstahl Rostfrei
Coupe-fruits, inox
Cortador tomates, inox

art.	dim. cm.	h.	kg.
49838-08	38x26	58	3,3



Set lame levator solo e trancia spicchi
Apple corer/wedger set of blades
Apfelentkerner-/Schneidmesser
Lames évideur/coupe-pommes
Saca corazón y cortador para manzanas

art.
49838-98



Pelatrice elettrica
Electric peeler
Elektr. Schälmaschine
Eplucheur électrique
Pelador eléctrico

art.	dim. cm.	h.	kg.
49750-00	25x16	21,5	2

Ideale per arance, limoni, pompelmi, kiwi, pomodori, pesche, ecc. 230 V. - To peel citrus, kiwis, tomatoes, peaches, grape-fruits, etc. 230 V.



Pela mele professionale
Professional apple peeler
Profi-Apfelschäler
Pèle-pommes, professionnel
Pelador de manzanas, profesional

art.	dim. cm.	h.	kg.
49834-00	32x14	10	1,9

Per pelare e tagliare mele e agrumi.
To peel and slice apples and citrus fruits.



Motore per pela mele art. 49834
Apple peeler motor for item 49834
Motor für Apfelschäler Art.-Nr. 49834
Moteur pour pèle-pommes réf. 49834
Motorización para artículo 49834

art.	V
49834-10	3,6



Pela arance con morsetto
Orange peeler with screw
Orangenschäler, Tischklemme
Pèle-orange, socle serre-joint
Pelador de naranjas, fijación brida

art.	dim. cm.	h.
49817-00	30x10	15



Pela mele con morsetto
Apple peeler with screw
Apfelschäler, Tischklemme
Pèle-pommes, socle serre-joint
Pelador de manzanas, fijación brida

art.	dim. cm.	h.
49835-00	30x10	17

Per pelare e tagliare. - To peel and slice.



Pela mele con ventosa
Apple peeler, vacuum-power base
Apfelschäler, Vakuüm-Fuss
Pèle-pommes, socle vacuum
Pelador de manzanas, fijación ventosa

art.	dim. cm.	h.
49836-00	30x10	13



Tagliaverdure ghirlanda, inox
Potato twist cutter, stainless steel
Kartoffeln-Spiralschneider, E.R.
Machine à brochette, inox
Coratador de verduras, inox

art.	dim. cm.	h.	kg.
49843-00	33x13	45	3,4

Spessore taglio 2,5 mm.
Slice thickness 2,5 mm.



Trancia spicchi per mela, inox
Apple corer/wedger, stainless steel
Apfelentkerner-/Schneider, Edelstahl
Lames évideur/coupe-pommes, inox
Cortador y descorazonador manzanas, inox

art.	ø cm.
48289-10	10

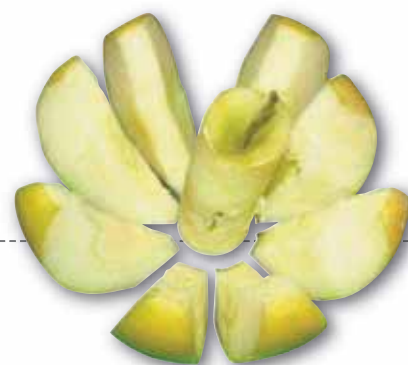

Taglia uova, inox
Egg wedger, stainless steel
Eierteiler, Edelstahl Rostfrei
Tranche-oeufs, inox
Cortahuevos, inox

art.	ø cm.	l.
42597-00	6,5	21



Apriuovo, inox
Egg knocker, stainless steel
Eierschneider, Edelstahl Rostfrei
Cut-oeufs, inox
Abre huevos, inox

art.	ø cm.	l.
42595-01	3,2	11



Taglia uova
Egg-slicer
Eierteiler
Tranche-oeufs
Cortahuevos doble uso

art.	dim. cm.	h.
42588-00	21x8	4,5



Taglia uova, alluminio
Egg-slicer, aluminum
Eierteiler, Aluminium
Tranche-oeufs rondelle, aluminium
Cortahuevos guitarra, aluminio

art.	dim. cm.	h.
42588-01	13,5x8	4,5



Contenitore per uova
Egg container
Eier-Behälter
Porte-oeufs
Contenedor para huevos

art.	dim. cm.	h.
47093-24	30x21,5	6,5



Contenitore per uova, acrilico
Egg container, acrylic
Eier-Behälter, Acryl
Porte-oeufs, acrilique
Conetnedor para huevos, acrílico

art.	dim. cm.	h.
44947-07	15x20	5

UTENSILI KITCHEN UTENSILS



P

Anelli per uova, inox
Egg rings, stainless steel
Eierringe, Edelstahl Rostfrei
Ronds à oeufs, inox
Anillos para huevos, inox

art.	ø cm.	u.pack
42596-02	8	2



Anello per uova, antiaderente
Egg ring, non stick
Eierring, beschichtet
Rond à oeufs, anti-adhésif
Anillo para huevos, antiadherente

art.	ø cm.	h.
42650-10	10	1,5



P

Anelli per uova, set 4 pz., inox
Egg rings, set 4 pcs., stainless steel
Eierringe, Satz 4 Stk., Edelstahl Rostfrei
Ronds à oeufs, set 4 pcs., inox
Anillos para huevos, 4 piezas, inox

art.	ø cm.
42651-10	10



Anello per uova, antiaderente
Egg ring, non stick
Eierring, beschichtet
Rond à oeufs, anti-adhésif
Anillo para huevos, antiadherente

art.	ø cm.	h.
42650-11	11	1,5



Taglia funghi, inox
Mushroom cutter, stainless steel
Pilze-Teiler, Edelstahl Rostfrei
Tranche-champignons, inox
Cortador de hongas, inox

art.	ø cm.	l.
42598-00	7,6	20,7



Pela/taglia avocado, inox
Avocado peeler and slicer, s/s
Avocadoschäler-/teiler, Edelstahl
Pèle et tranche avocat, inox
Pelador y cortador de aguacete, inox

art.	l. cm.
48286-62	18,5



Pela anguria /zucca, inox
Watermelon/pumpkin peeler, s/s
Wassermelone u. Kürbis-Schäler, E. R.
Eplucheur pastèque/potiron, inox
Pelador de sandía y calabaza, inox

art.	dim. cm.
48286-63	16x10



Pelaverdure, inox
Large vegetable slicer, stainless steel
Gemüseschäler, Edelstahl Rostfrei
Eplucheur à légumes, inox
Pelador de verduras, inox

art.	dim. cm.
48286-64	22x10



Pelapatate
Potato peeler
Sparschäler
Eplucheur
Pelador de patatas

art.	dim. cm.
42589-00	5x4



Schiacciapatate 3 griglie, inox
Potato ricer with 3 discs, stainless steel
Kartoffelpresse, 3 Roste, Edelstahl
Presse-purée 3 grilles, inox
Prensa patatas, 3 discos, inox

art.	ø cm.	ø mm.
42566-03	8,5	2,4-4,4-6,5



Taglia patate, inox
French fry cutter, stainless steel
Kartoffelschneidgerät, Edelstahl Rostfrei
Coupe-frites, inox
Cortador de patatas fritas, inox

art.	dim. cm.	h.	kg.
49832-10	24x44	34	11

Fornito con quadro di taglio 10 mm, disponibili su richiesta da 8 e 6 mm.
Equipped with 10 mm cutting knife, available upon request 8 & 6 mm. spare assemblies.



Taglia patate, inox
French fry cutter, stainless steel
Kartoffelschneidgerät, Edelstahl Rostfrei
Coupe-frites, inox
Cortador de patatas fritas, inox

art.	dim. cm.	h.	kg.
49832-02	26x9	12,5	1,2

Fornito con 2 quadri di taglio da 9x9 mm e 12x12 mm. - Equipped with 2 cutting knives of 9x9 mm & 12x12 mm.



Grattugia formaggio rotatoria
 Cheese rotary grater
 Drehe-Käse-Raffel
 Frisette à fromage
 Ralladora giratoria para queso

art.	ø cm.	h.	gr.
48281-22	22	16	250

Base legno. - Wood base.

Cloche per grattugia rotatoria
 Rotary grater cover
 Käse-Raffel-Deckel
 Cloche à frisette
 Tapa para ralladora

art.	ø cm.	h.
48281-23	15,5	11



Forbice per erbe, 5 lame
 Herb scissors
 Kräuterschere
 Ciseaux à herbes
 Tijeras hierbas

art.	l. cm.
18277-00	10



Taglia mango
 Mango cutter
 Mango Messer
 Coupe mangue
 Cortador y descorazonador mangos

art.	dim. cm.	gr.
48286-65	21,5x13,5	105



Taglia mango
 Mango cutter
 Mango Messer
 Coupe mangue
 Cuchillo par mango

art.	dim. cm.	h.	gr.
48286-66	10,5x10	17,5	470



Grattugia automatica
 Grater, automatic
 Raffel, automatisch
 Râpe automatique
 Rallador automático

art.	dim. cm.	gr.
48295-10	20x5,4	360



Dotazione: recipiente ermetico, contenitore removibile con coperchio, 2 lame. Ideale per formaggio, noci, cioccolato, ecc. Funzionamento con 4 pile alcaline LR6 AA. - Equipment: hermetic container, removable container with lid, 2 blades. Ideal for cheese, nuts, chocolate, etc. Powered by 4 alkaline batteries LR6.



Taglia tortillas, inox
Tortillas wedger, stainless steel
Tortillasteiler, Edelstahl Rostfrei
Coupe-tortillas, inox
Corta tortillas, inox

art.	Ø cm.	
42599-06	25	6 parti/wedges
42599-08	25	8 parti/wedges



Lira per formaggi, inox
Cheese wire cutter, stainless steel
Käse Drahtschneider, Edelstahl Rostfrei
Lyre à fromage, inox
Lira para quesos, inox

art.	dim. cm.
48282-21	20,5x26,7



Spremiaglio, inox
Garlic press, stainless steel
Knoblauchpresse, Edelstahl Rostfrei
Presse-ail, inox
Prensador de ajo, inox

art.	Ø cm.
42565-00	2,7



Snocciolatore, cromato
Olive seed remover, chromed
Olivenentsteiner, verchromt
Dénoyauteur, chromé
Quita pepa/hueso, cromado

art.	l. cm.
42563-00	17



Snocciolatore
Cherry core stripper
Kirschenentsteiner
Dénoyauteur de cerises
Quita pepa/hueso

art.	Ø cm.	h.
42563-44	10	34



Mandolino, inox
Mandoline, stainless steel
Gemüsehobel Mandoline, Edelstahl
Mandoline, inox
Mandolina, inox

art.	dim. cm.	h.	kg.
49829-11	39x12,5	5,5	1,7

Dotato di 7 lame intercambiabili.
Equipped with 7 interchangeable blades.

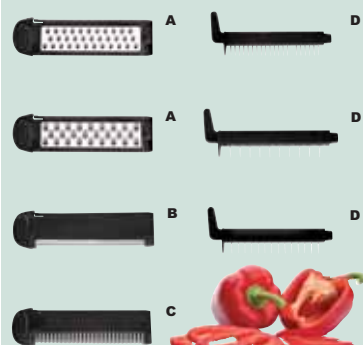

Il set di lame include due lame a grattugia (A), una lama a filo dritto (B), una lama a filo ondulato (C) e 3 lame da julienne con diverso spessore (D).
The blade set includes two grating blades (A), a straight edge master blade (B), a "crinkle" edge master blade (C) and 3 different width julienne blades (D).



Mandolino Grand Gourmet, inox
Slicer Mandoline, Grand Gourmet, s/s
Gemüsehobel Grand Gourmet, Edelstahl
Mandoline Grand Gourmet, inox
Mandolina Grand Gourmet, inox

art.	dim. cm.	h.	kg.
49830-60	40x12	28	1,6

Dotato di 38 lame, 10 mm, su richiesta kit di taglio da 4,5 e 7 mm. - Equipped with 38 blades, 10 mm, available upon request 4,5 & 7 mm. spare assemblies.

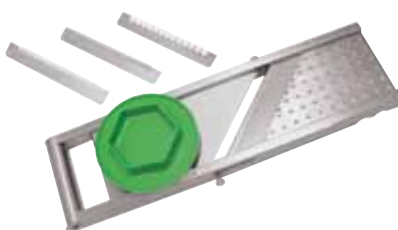

Mandolino, inox
Mandoline, stainless steel
Gemüsehobel Mandoline, Edelstahl
Mandoline, inox
Mandolina, inox

art.	dim. cm.	h.	kg.
49752-00	33,5x11	2,3	0,6

Dotato di 3 lame intercambiabili da 2-3-6 mm. - Equipped with 3 interchangeable blades, 2-3-6 mm.



Mandolino giapponese, ABS
Japanese Mandoline slicer, ABS
Japanese Gemüsehobel, ABS
Mandoline japonaise, ABS
Mandolina japonés, ABS

art.	dim. cm.	h.	kg.
49753-06	11x31,5	3,0	0,3
49753-09	15x35	3,3	0,5

Dotato di 1 lama liscia e 3 lame da 1-2-3 mm. - Equipped with 1 plain blade and 3 blades of 1-2-3 mm.



P

Mandoline
Mandoline
Gemüsehobel Mandoline
Mandoline
Mandolina

art.	dim. cm.	h.
48295-02	18x5	7



P

Mandolino automatico
Mandoline, automatic
Gemüsehobel Mandoline, automatisch
Mandoline automatique
Manbdolina automática

art.	dim. cm.	h.	gr.
48295-11	28,4x10,2	19,4	660

Dotato di 1 lama Julienne e 3 lame lisce. Equipped with 1 julienne and 3 plain blades.



P

Mini tritattutto
Mini chopper
Mini chopper
Mini-Zwiebel-Schneider
Mini cortador

art.	ø cm.	h.
48295-08	12	10



Intaglia verdure, inox
Cutter/corer, stainless steel
Ausstechforme, Edelstahl Rostfrei
Découpoir, inox
Sacabocados, inox

art.	dim. cm.	h.
48286-70	3,7x8,5	9

Diametro di taglio 3,4 cm. Cutting diameter 3,4 cm.



Turn'up, inox
Cutter, stainless steel
Ausstechforme, Edelstahl Rostfrei
Découpoir, inox
Sacabocados, inox

art.	ø cm.	h.
48285-04	4	14,5
48285-05	5	14,5



N

Set decoro 4 pezzi, inox
Decoration kit, 4 tools, stainless steel
Dekoriersatz, 4-Tlg.
Kit 3 tubes découpoirs + 1 poussoir, inox
Juego 4 herramientas de decoración, inox

art.	ø mm.	h. mm.
48286-72	10-15-20	100



Set decoro 8 pezzi, inox
Decoration kit, 8 tools, stainless steel
Dekoriersatz, 8-Tlg.
Kit 5 tubes découpoirs + 3 poussoirs, inox
Juego 8 herramientas de decoración, inox

art.	ø mm.	h. mm.
48286-71	5-10-15-20-25	130



Per creare combinazioni insolite di frutta, verdura, pane, formaggi... spiedini originali, dalla grafica colorata. To create unusual combinations of fruits, vegetables, bread, cheese... original colorful skewers.



P

-  **GRATTUGIARE**
SHRED
-  **AFFETTARE**
SLICE
-  **FRAMMENTARE**
CHIP



Taglia verdure, plastica
Spiral Vegetable Slicer tri-Blade, plastic
Gemüseschneider, Kunststoff
Coupe légumes, plastique
Cortador de verduras, plástico

art. dim. cm. h.
49827-99 30x14 22

Dotato di tre lame intercambiabili in acciaio inox (3 mm, 6 mm e una lama dritta per taglio a nastro). Supporto dotato di rebbi per fissare al meglio verdura e frutta. Maneggevole nell'utilizzo e semplice da pulire. Ideale per realizzare julienne, chips, riccioli, anelli e fette sottili di verdura e frutta. - *Equipped with three interchangeable blades made of stainless steel (3 mm, 6 mm and a straight blade for ribbon cuts). Wheel with prongs to easily secure vegetables and fruits. Versatile and easy to clean. Ideal for making julienne cuts, chips, spiral shapes, rings and plain slices of vegetables and fruits.*



N

P

Taglia verdure 4-lame, plastica
Turning slicer 4-blades, plastic
Gemüseschneider, Kunststoff
Coupe légumes, plastique
Cortador de verduras, plástico

art. dim. cm. h.
49826-99 15,5x25 15



Stoccaggio sicuro e compatto. Multi-funzionale 4 lame - per affettare (2,5 mm), fine (3x3mm) e grossa (4x6mm) per tritatore e capelli d'angelo (1,2x2mm). Per fare svariati tipi di spirale e tagli, sminuzzare, tagliatelle, anelli, chip, ecc. Ideale per patate, zucchine, carote, ravanelli, mele, cavoli, ecc. Perno per fare spiedini a spirale. Il coperchio può essere utilizzato come vassoio. Pressatore adatto sia per ambidestri che per mancini. - *Foldable turning slicer, easy assembly, safe and compact storage. Multi-functional 4 blades - slicer (2,5mm), fine (3x3mm) and coarse (4x6mm) shredder and angel hair (1,2x2mm). Make many kinds of spiral slicing & shredding such as noodles, rings, curvy chips & twist. Works great with potatoes, zucchini, carrots, radishes, apples and cabbages etc. Bonus pin for making spiral cut skewers with slicer blade. Storage cover can be used as food tray. Pusher adapts both left & right hand users.*



Taglia verdure, inox
Strip slicer, stainless steel
Gemüseschneider, Edelstahl Rostfrei
Coupe-lanières, inox
Cortador de verduras japonés, inox

art. dim. cm. h. kg.
49823-00 20x20 20 1,9

Lavabile in lavastoviglie. Blocco di taglio da 1,5 mm. Lunghezza max verdura 11 cm. ø max 17 cm. - *Dishwasher safe. Cutting block 1,5 mm. Max vegetables length 11 cm. Max ø 17 cm.*



Taglia verdure, plastica
Strip slicer, plastic
Gemüseschneider, Kunststoff
Coupe lanière, plastique
Cortador de verduras, plástico

art. dim. cm. h.
49823-89 24x23 18

Permette di tagliare in bande larghe e sottili verdure e frutta. Lama inox. Larghezza taglio 15 cm. - *To cut vegetables and fruits in large and thin stripes. Equipped with stainless steel blade. Width of cut 15 cm.*



Taglia verdure, plastica
Strip & spaghetti slicer, plastic
Gemüseschneider, Kunststoff
Coupe lanière et spaghetti, plastique
Cortador de verduras japonés, plástico

art. dim. cm. h.
49823-99 24x23 18

Taglia verdure giapponese dotato di lame reversibili in acciaio inox per tagliare a bande o a spaghetti. Larghezza del taglio 10 cm. - *Equipped with stainless steel reversible blades to cut vegetables in stripes or spaghetti. Width of cut 10 cm.*



Taglia verdure LE ROUET GOURMET
Vegetable cutter
Gemüseschneider
Coupe légumes
Cortador de verduras

art.	dim. cm.	h.	kg.
49827-03	13,5x36	24,3	2,4

Dotato di set di taglio da 1-2-4 mm.
Disponibili set di taglio da 7 mm.
Equipped with cutting blocks 1-2-4 mm.
Available cutting block 7 mm.



Set 2 cucchiai decorazione
Set 2 decorating spoons
Satz 2 Dekoration-Löffel
Set 2 cuillères pour décorer
2 cucharas para decoración



art.
47831-02

Per decorazioni su piatti con salse, panna, caramello, purea, ecc., ecc. Piccolo per preparazioni dolci, grande per salate. - To make decorations on dishes with sauces, cream, caramel, puree, etc. Small spoon to decorate sweets, a larger one for savory preparations.



Taglia cipolla a fiore
Blossom onion cutter
Zwiebel-blumenschneider
Coupe-oignon en fleurs
Cortador de cebollas en flores

art.	ø cm.
48216-10	9,5



Taglia in 6, inox
Cut in six, stainless steel
Schneidergerät, Edelstahl Rostfrei
Coupe en six, inox
Cortador en seis, inox

art.	ø cm.	h.
48286-60	8,5	9,5



Decora verdure, ghirlanda
Vegetable decorating tool
Dekoriergerät
Decò guirlande
Decorador guirlanda

art.	l. cm.
48284-00	15,5



Decora verdure, spirale
Vegetable decorating tool
Dekoriergerät
Decò spiral
Decorador espiral

art.	ø cm.	l.
48283-00	1,3	23,5
48283-01	1,0	23,5
48283-02	0,7	23,5



Decora verdure, quadro
Vegetable decorating tool
Dekoriergerät
Decò spiral
Decorador espiral

art.	l. cm.
48283-03	23,5



Decora verdure, rombo
Vegetable decorating tool
Dekoriergerät
Decò spiral
Decorador espiral

art.	l. cm.
48283-04	23,5



Decora verdure, doppio
Vegetable decorating tool
Dekoriergerät
Decò spiral
Decorador espiral

art.	l. cm.
48283-05	23,5



Kit 4 attrezzi decoro
4 fluted chisel set
Dekoriersatz, 4-Tlg.
Lot 4 gouges cannelées
Juego de 4 cinceladores estriados

art.
48286-05



Stiletto thailandese
Thai knife
Thai-Messer
Couteau stilet thai
Cuchillo tailandés

art.	l. cm.
48286-08	17



Libro 'Scolpire frutta e verdura'

Testo in italiano - Text in Italian only.

art.	96 pages
48287-20	96 pages

UTENSILI KITCHEN UTENSILS



Valigia attrezzi decoro, 45 pz.
 Decoration case, 45 tools
 Dekorierkoffer, 45 -Tlg.
 Mallette 45 outils décor
 Maletín de 45 herramientas de decoración

art.	dim. cm.	kg.
48286-18	40x32x10,5	2,8



Valigia attrezzi decoro, 26 pezzi
 Decoration case, 26 tools
 Dekorierkoffer, 26-Tlg.
 Mallette 26 outils décor
 Maletín de 26 herramientas decoración

art.
48286-01



Pochette attrezzi decoro, 22 pezzi
 Decoration case, 22 tools
 Dekoriersatz, 22-Tlg.
 Pochette 22 outils décor
 Estuche de 22 herramientas decoración

art.
48286-13



Kit 18 attrezzi decoro
 Kit of 18 decoration tools
 Dekoriersatz, 18-Tlg.
 Kit 18 outils de décor
 Kit de 22 herramientas decoración

art.
48286-03



Poster 'La cuisine'

art.	dim. cm.
48287-10	63x90,5



Set 3 foglie, inox
 Set of 3 leaves, stainless steel
 Ausstechformen-Set, 3-tlg., Edelstahl Rostfrei
 Set découpoirs, 3 pcs, inox
 Kit de 3 cortadores, inox

art.	dim. cm.
48286-47	6,4x3,3 - 8,7x4,5 - 10,6x6,1



Set 3 foglie, inox
 Set of 3 leaves, stainless steel
 Ausstechformen-Set, 3-tlg., Edelstahl Rostfrei
 Set découpoirs, 3 pcs, inox
 Kit de 3 cortadores, inox

art.	l. cm.
48286-46	6 - 8 - 11



Set 3 foglie, inox
Set of 3 leaves, stainless steel
Ausstechformen-Set, 3-tlg., Edelstahl Rostfrei
Set découpoirs, 3 pcs, inox
Kit de 3 cortadores, inox

art. dim. cm.
48286-45 9x2,6 - 12x3,5 - 15x4,5

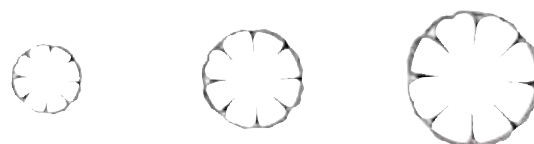

Set 3 fiori, inox
Set of 3 flowers, stainless steel
Ausstechformen-Set, 3-tlg., Edelstahl Rostfrei
Set découpoirs, 3 pcs, inox
Kit de 3 cortadores, inox

art. ø cm.
48286-48 4,7 - 7 - 9



Fiore susino, inox
Plum blossom, stainless steel
Ausstechform, Edelstahl Rostfrei
Découpoir, inox
Cortador, inox

art. dim. cm.
48286-28 3,6x3,5



Mantecatore per maionese
Mayomaker
Mayonnaisefaß
Baratte à mayonnaise
Mantequera a mayonesa

art. dim. cm. kg.
48294-12 13,5x17x37 1,3



Mantecatore per burro
Butter churn
Butterfaß
Baratte à beurre
Mantequera

art. dim. cm. lt.
48294-01 11,5x11,5x40 1,6



Stampo per burro
Butter mold
Butterform
Moule à beurre
Molde para mantequilla

art. dim. cm. h. gr.
48294-02 12,2x6,6 4,3 80



Stampo per burro
Butter mold
Butterform
Moule à beurre
Molde para mantequilla

art. dim. cm. h. gr.
48294-03 15,8x9 5,0 125



Stampo per burro
Butter mold
Butterform
Moule à beurre
Molde para mantequilla

art. dim. cm. h. gr.
48294-04 21x9,4 5,8 250



P GRATTUGIE - GRATERS

GRATERS / **PRO**



Formaggi teneri e stagionati.
Soft & hard cheese.



Agrumi.
Citrus, lemon.



Verdure cipolla e aglio.
Vegetables, onion & garlic.



Cioccolato.
Chocolate.



Frutta secca, peperoncino e aglio.
Nuts, pepper & garlic.

**UTENSILI KITCHEN UTENSILS
GRATTUGIE GRATERS**



Grattugia inox, manico antiscivolo
Grater, stainless steel, non-slip handle
Raffel, Edelstahl Rostfrei, Rutschfestes Griff
Râpe inox, queue antidérapant
Rallador inox, mango antiderrapante

Grattugia inox, manico antiscivolo
Grater, stainless steel, non-slip handle
Raffel, Edelstahl Rostfrei, Rutschfestes Griff
Râpe inox, queue antidérapant
Rallador inox, mango antiderrapante

Grattugia inox, manico antiscivolo
Grater, stainless steel, non-slip handle
Raffel, Edelstahl Rostfrei, Rutschfestes Griff
Râpe inox, queue antidérapant
Rallador inox, mango antiderrapante

art. dim. cm. l.
42560-01 4x22 38,5

art. dim. cm. l.
42560-02 4x22 38,5

art. dim. cm. l.
42560-03 4x22 38,5



Grattugia inox, manico antiscivolo
Grater, stainless steel, non-slip handle
Raffel, Edelstahl Rostfrei, Rutschfestes Griff
Râpe inox, queue antidérapant
Rallador inox, mango antiderrapante

Grattugia inox, manico antiscivolo
Grater, stainless steel, non-slip handle
Raffel, Edelstahl Rostfrei, Rutschfestes Griff
Râpe inox, queue antidérapant
Rallador inox, mango antiderrapante

Grattugia inox, manico antiscivolo
Grater, stainless steel, non-slip handle
Raffel, Edelstahl Rostfrei, Rutschfestes Griff
Râpe inox, queue antidérapant
Rallador inox, mango antiderrapante

art. dim. cm. l.
42560-04 7,7x13,3 30

art. dim. cm. l.
42560-05 7,7x13,3 30

art. dim. cm. l.
42560-06 7,7x13,3 30

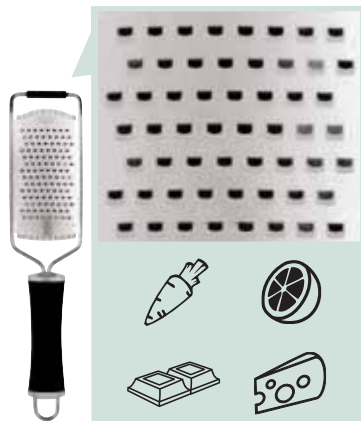

Grattugia inox, manico antiscivolo
Grater, stainless steel, non-slip handle
Raffel, Edelstahl Rostfrei, Rutschfestes Griff
Râpe inox, queue antidérapant
Rallador inox, mango antiderrapante

Grattugia inox, manico antiscivolo
Grater, stainless steel, non-slip handle
Raffel, Edelstahl Rostfrei, Rutschfestes Griff
Râpe inox, queue antidérapant
Rallador inox, mango antiderrapante

Grattugia inox, manico antiscivolo
Grater, stainless steel, non-slip handle
Raffel, Edelstahl Rostfrei, Rutschfestes Griff
Râpe inox, queue antidérapant
Rallador inox, mango antiderrapante

art. dim. cm. l.
42560-07 7,7x13,3 30

art. dim. cm. l.
42560-08 7,7x13,3 30

art. dim. cm. l.
42560-09 7,7x13,3 30



Grattugia per spätzle, inox
Spätzle sieve, s/s
Spätzle-Raffel, Edelstahl Rostfrei
Grille à spätzle, inox
Rallador para spätzle, inox

art.	dim. cm.	h.
49844-01	31x10,5	6



Preparazione tipica della Germania meridionale. Gnocchetti a base di farina di grano tenero, uova e acqua, dalla caratteristica forma a goccia che si ottiene con una grattugia formata da una base bucherellata sulla quale scorre un recipiente contenente l'impasto che viene fatto scorrere avanti e indietro. Dopo essere stati lessati, gli Spätzle vengono ripassati nel burro e serviti come primo piatto o come contorno. - *Spätzle are a typical preparation of southern Germany. These are dumplings made from wheat flour, eggs and water. Spätzle have a characteristic shape of a drop which is obtained with a special grater formed by a perforated base on which slides a basin containing the mixture. After being boiled, the Spätzle are heated up in butter and served as a first course or as side dish.*



Grattugia noce moscata, inox
Nutmeg grater, s/s
Muskatrafel, Edelstahl Rostfrei
Râpe à muscade, inox
Rallador nuez moscada, inox

art.	dim. cm.
42556-00	4,5x14



P

Grattugia 4 tagli, inox
4-ways grater, s/s
Raffel, Edelstahl Rostfrei
Râpe, inox
Rallador, inox

art.	dim. cm.	h.
42569-04	10x8	23



Grattugia a tamburo
Rotary grater
Trommelreibe
Râpe rotative
Rallador rotativo

art.	dim. cm.	h.	kg.
49756-00	16x22	45	2,4

Dotata di 3 tamburi: verdure, parmigiano e gruyère. - *Equipped with 3 drums: vegetables, parmesan, gruyère cheese.*



Sfogliatrice manuale
Noodle machine
Nudelschneidmaschine
Coupe-nouilles
Máquina de pasta

art.	dim. cm.	h.	kg.
49840-00	30x22	25	9,8

Tagliasfoglia da ordinarsi separatamente. *Cutting rollers to be ordered separately.*



Sfogliatrice elettronica
Electronic pasta machine
Elektrischer Teigausroller
Machine à abaisse électronique
Máquina para hojaldrar electrónica

art.	dim. cm.	h.	kg.
49841-00	31x26	29,5	18,3

230V/50Hz 290W - Velocità di rotazione rulli da 5 a 100 giri/max. Campo di regolazione 0-5 mm. Produzione sfoglia 12 kg/h. Larghezza sfoglia 210 mm. Tagliasfoglia da ordinarsi separatamente. *Rotational speed of the rollers from 5 to 100 max. Rollers setting range 0-5 mm. Pasta output 12kg/h. Pasta sheet width 210 mm. Cutting rollers to be ordered separately.*



Sfogliatrice elettrica
Electric pasta machine
Elektrischer Teigausroller
Machine à abaisse électrique
Máquina para hojaldrar eléctrica

art.	dim. cm.	h.	kg.
49849-00	30x22	25	14,8

230V/50Hz 290W - Velocità di rotazione rulli 45 giri/min. Campo di regolazione 0-5 mm. Produzione sfoglia 12 kg/h. Larghezza sfoglia 210 mm. Tagliasfoglia da ordinarsi separatamente. - *Rotational speed of the rollers 45 per min. Rollers setting range 0-5 mm. Pasta output 12kg/h. Pasta sheet width 210 mm. Cutting rollers to be ordered separately.*



Tagliasfoglia
Cutting roller
Schneidewalzen
Cylindres de coupe
Cortador de pasta

art.	mm.
49840-01	12 lasagnette



Tagliasfoglia
Cutting roller
Schneidewalzen
Cylindres de coupe
Cortador de pasta

art. mm.
49840-02 2 tagliatelle



Tagliasfoglia
Cutting roller
Schneidewalzen
Cylindres de coupe
Cortador de pasta

art. mm.
49840-03 1,5 capelli d'angelo



Tagliasfoglia
Cutting roller
Schneidewalzen
Cylindres de coupe
Cortador de pasta

art. mm.
49840-04 4 trenette



Tagliasfoglia
Cutting roller
Schneidewalzen
Cylindres de coupe
Cortador de pasta

art. ø mm.
49840-05 2 spaghetti



Tagliasfoglia
Cutting roller
Schneidewalzen
Cylindres de coupe
Cortador de pasta

art. mm.
49840-06 6,5 fettuccine



Tagliasfoglia
Cutting roller
Schneidewalzen
Cylindres de coupe
Cortador de pasta

art. mm.
49840-07 12 reginette



RAVIOLI Stampo, alluminio
Mould, aluminum
Formen, Aluminium
Moule, aluminium
Molde, aluminio

art. dim. mm. pz/pcs
49840-30 34x34 24



RAVIOLI Stampo, alluminio
Mould, aluminum
Formen, Aluminium
Moule, aluminium
Molde, aluminio

art. dim. mm. pz/pcs
49840-31 34x34 36



RAVIOLI da BRODO Stampo, alluminio
Mould, aluminum
Formen, Aluminium
Moule, aluminium
Molde, aluminio

art. dim. mm. pz/pcs
49840-32 25x25 44

Stendipasta è pratico e robusto, risolve ogni problema di spazio. Consente di stendere più di 1 kg di pasta ed è un prodotto naturale costruito in faggio evaporato. - *Stendipasta is practical, sturdy and solves all problems of space. On this pasta drying rack you can hang over 1 kg of pasta and it is a natural product made of evaporated beechwood.*



Stendipasta
Pasta drying rack
Nudel-Trockner
Séchoir à pâtes
Tendadero para pasta

art. dim. cm.
49840-20 33x37x37



TORTELLI Stampo, alluminio
Mould, aluminum
Formen, Aluminium
Moule, aluminium
Molde, aluminio

art. dim. mm. pz/pcs
49840-33 60x60x60 18



RAVIOLI CHEF Stampo, alluminio
Mould, aluminum
Formen, Aluminium
Moule, aluminium
Molde, aluminio

art. dim. mm. pz/pcs
49840-34 52x52 12



Stampo panzerotti
Dumplin maker
Knödel-Form
Moule à chausson
Molde para empanadillas

art. tagli/cuts mm.
49843-05 62 - 82 - 104 - 177



Compatta-bottiglie
Bottle-crasher
Flaschen-Zerquetscher
Presse-bouteilles
Compactador para botellas

art. dim. cm. h. kg.
48221-00 38x18 37 1,4

Diametro del nucleo 5,5 cm adatto a tutti i tipi di collo. Costruzione in materiale composito e acciaio inox. - Core diameter 5,5 cm suitable for all types of neck. Construction in composite material and stainless steel.



Apriscatole sicuro
Safety can opener
Sicherheitsdosenöffner
Ouvre-boîte de sûreté
Abrelatas de seguridad

art. dim. cm.
48222-01 12,5x8



Apriscatole professionale
Professional can opener
Profí-Dosenöffner
Ouvre-boîte, professionnel
Abrelatas profesional

art. dim. cm.
48220-00 8x7



Apriscatole, impugnatura PP
Can opener, PP handle
Dosenöffner, Griffe aus PP
Ouvre-boîte, poignées PP
Abrelatas, mango PP

art. l. cm.
48280-03 21



Passaverdura elettrico, inox
Electric sieve, s/s
Elektropassiergerät, Edelstahl Rostfrei
Moulin électrique, inox
Molino eléctrico, inox

art. ø cm. h. kg.
49879-37 37 108 35

Motore trifase 380V. Griglia in dotazione 3 mm. - Threephase motor 380V. Equipped with 3 mm disc.



Passaverdura stagnato con supporto
Sieve on tripod, tinned
Passiergerät, verzinkt, mit Träger
Moulin étamé sur pied
Molino estañado sobre pie

art. ø cm. h. kg.
42577-39 39 80 14

Griglia in dotazione 3 mm. Equipped with 3 mm disc.



Passapomodori, professionale
Tomato juicer sieve
Profí-Tomatenpassiergerät
Moulin à tomates professionnel
Molino para tomates, profesional

art. ø cm. h.
42576-00 21 50

Griglia in dotazione 1 mm. Equipped with 1 mm disc.



Macinaerbe, inox
Herb mill, s/s
Kräutermühle, Edelstahl Rostfrei
Moulin fines herbes, inox
Molino de hierbas finas, inox

art.	dim. cm.
42558-00	7x22



Passaverdura inox, 3 griglie
Sieve, stainless steel, 3 discs
Passiergerät, Edelstahl Rostfrei, 3 Roste
Moulin inox, 3 grilles
Molino inox, 3 rejillas

art.	ø cm.	h.	kg.
42571-20	19	16,5	0,46



Passaverdura inox, 3 griglie
Sieve, stainless steel, 3 discs
Passiergerät, Edelstahl Rostfrei, 3 Roste
Moulin inox, 3 grilles
Molino inox, 3 rejillas

art.	ø cm.	h.	kg.
42572-24	24	16,5	0,82

Griglie/Discs: 1,5 - 2 - 4 mm.



Passaverdura inox, 3 griglie
Sieve, stainless steel, 3 discs
Passiergerät, Edelstahl Rostfrei, 3 Roste
Moulin inox, 3 grilles
Molino inox, 3 rejillas

art.	ø cm.	h.	kg.
42570-32	32	25	1,4



Passaverdura stagnato, 3 griglie
Sieve, tinned, 3 discs
Passiergerät, verzinkt, 3 Roste
Moulin étamé, 3 grilles
Molino estañado, 3 rejillas

art.	ø cm.	h.	kg.
42573-31	32	25	1,4

Griglie/Discs: 1,5 - 2,5 - 4 mm.



Passaverdura inox, 1 griglia
Sieve, stainless steel, 1 disc
Passiergerät, Edelstahl Rostfrei, 1 Rost
Moulin inox, 1 grille
Molino inox, 1 rejilla

art.	ø cm.	h.	kg.
42574-37	37	32	3,5

Griglia/Disc: 3 mm.



Passaverdura stagnato, 1 griglia
Sieve, tinned, 1 disc
Passiergerät, verzinkt, 1 Rost
Moulin étamé, 1 grille
Molino estañado, 1 rejilla

art.	ø cm.	h.	kg.
42575-37	37	32	3,5

Griglia/Disc: 3 mm.



Griglie per art.
Discs for item
Roste für Art.-Nr.
Grilles pour réf. 42577 - 49879
Rejillas para art. 42574 - 42575

art.	mm.
-90	1,0
-91	1,5
-92	2,0
-93	3,0
-94	4,0



Griglie per art.
Discs for item
Roste für Art.-Nr.
Grilles pour réf.
Rejillas para art. 42570 - 42573

art.	mm.
-91	1,5
-92	2,5
-94	4,0

UTENSILI KITCHEN UTENSILS



Apriscatole
Table top can opener
Tisch-Dosenöffner
Ouvre-boîte
Abrelatas

art. l. cm.
19811-00 50

Corpo in alluminio pressofuso, testa in acciaio, fissaggio a viti o morsetto. - *Clamp base and bar in cast iron, stainless steel head. Table fixing either with screws or clamp.*



Apriscatole
Table top can opener
Tisch-Dosenöffner
Ouvre-boîte
Abrelatas

art. l. cm.
19810-00 56



Apriscatole da banco, acciaio
Table top can opener, steel
Tisch-Dosenöffner, Edelstahl
Ouvre-boîte, acier
Abrelatas, acero

art. l. cm.
49811-00 40

Testa in materiale composito epossidico, fissaggio a morsetto, base 18x8 cm. Lama inox reversibile. - *Composite material head. Table fixing either with clamp, base 18x8 cm. Stainless steel reversible blade.*



Apriscatole da banco, inox
Table top can opener, stainless steel
Tisch-Dosenöffner, Edelstahl Rostfrei
Ouvre-boîte, inox
Abrelatas, inox

art. l. cm.
49812-00 55

Fissaggio a morsetto, base 22x12 cm. Lama inox reversibile. - *Table fixing with clamp, base 22x12 cm. Stainless steel reversible blade.*



Apriscatole elettrico, inox
Electric can opener, stainless steel
Elektrodosenöffner, Edelstahl Rostfrei
Ouvre-boîte électrique, inox
Abrelatas eléctrico, inox

art. dim. cm. h. kg.
49814-00 44x25 75 13

230V - 75W. Motore a 2 velocità. Per tutti i formati di scatola da 50 a 270 mm di altezza. - *Dual speed motor. Opens all can shapes from 50 to 270 mm height.*



Apriscatole da banco, inox
Table top can opener, stainless steel
Tisch-Dosenöffner, Edelstahl Rostfrei
Ouvre-boîte, inox
Abrelatas, inox

art. l. cm.
49861-10 55

Lavabile in lavastoviglie, cambio rapido lama e sistema ingranaggi, modello con morsetto. Ideale per 15-20 lattine al giorno di h. 43 cm max. - *Dishwasher safe, features quick change knife and gear system, clamp model. For uses up to 15-20 cans per day, max height 43 cm.*



Apriscatole da banco
Table top can opener
Tisch-Dosenöffner
Ouvre-boîte
Abrelatas

art. l. cm.
49861-00 56

Corpo e asta in acciaio inox, testa in acciaio, fissaggio con morsetto. - *Clamp base and bar in stainless steel, cast iron head. Table fixing with clamp.*



Apriscatole elettrico, inox
Electric can opener, stainless steel
Elektrodosenöffner, Edelstahl Rostfrei
Ouvre-boîte électrique, inox
Abrelatas eléctrico, inox

art. dim. cm. h. kg.
49862-00 11x16 28 6,5

Motore a 2 velocità. Altezza max scatola 17 cm. - *Dual speed heavy motor. Cans max height 17 cm.*



Spazzola di pulizia
Cleaning brush
Reinigungsbürste
Brosse de nettoyage
Cepillo para limpieza

art.
49861-01

TERMOMETRI THERMOMETERS

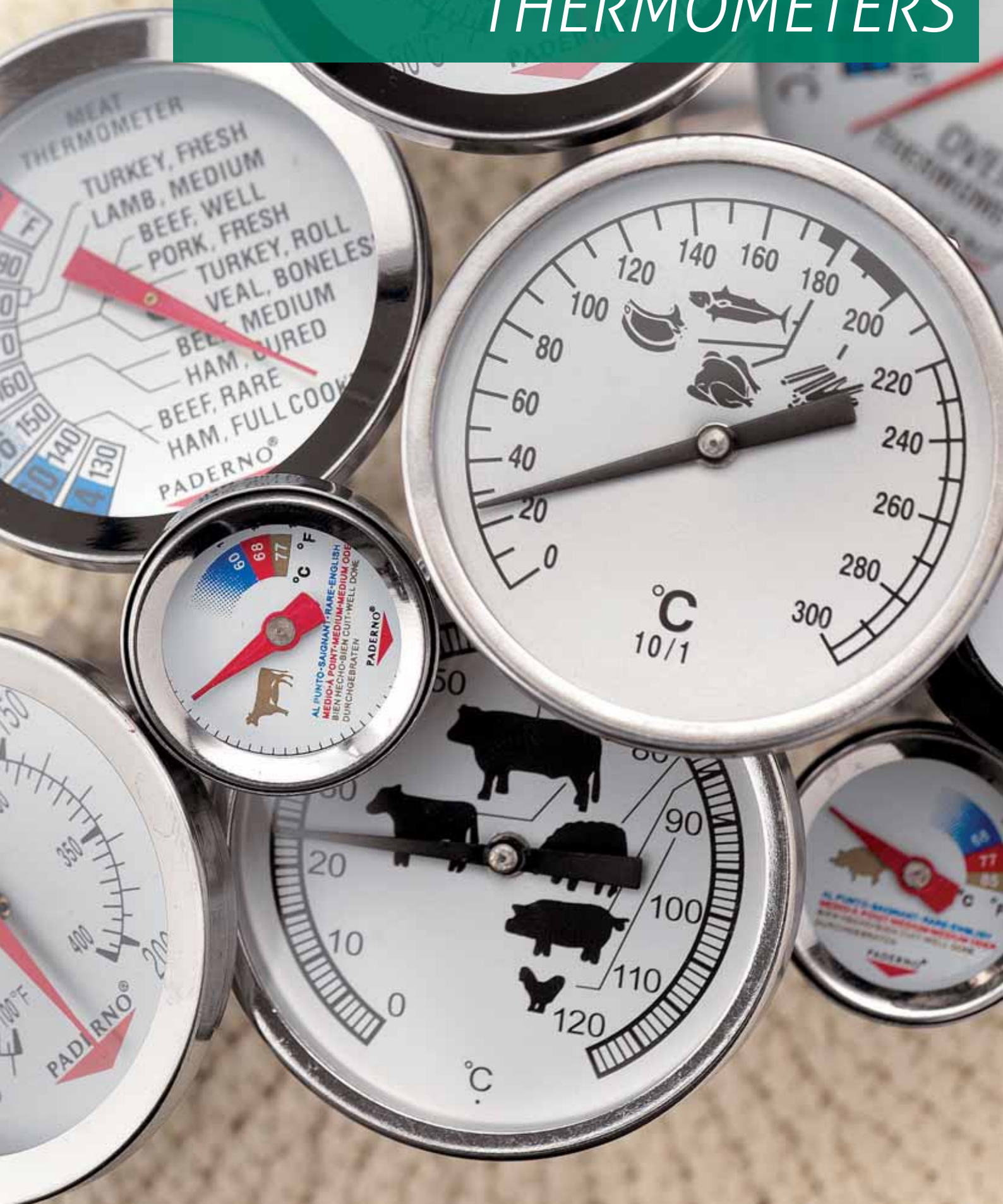

UTENSILI KITCHEN UTENSILS



P

Termometro arrosti
Meat roasting thermometer
Braten-Thermometer
Thermomètre à rôtir
Termómetro asado

art. ø cm. scala range
49705-00 4,5 1°C 0+120°C

Lunghezza sonda 13 cm.
Penetration probe 13 cm.



P

Termometro arrosti
Meat roasting thermometer
Braten-Thermometer
Thermomètre à rôtir
Termómetro asado

art. ø cm. range
19705-00 5 +54+88°C



P

Termometro fritti
Cooking & frying thermometer
Back-Thermometer
Thermomètre à friture
Termómetro frituras

art. ø cm. scala range
19706-00 5 10°C +38+205°C



Termometro per zucchero
Sugar thermometer
Zuckerthermometer
Thermomètre à sucre
Termómetro azúcar

art. l. cm. scala range
47843-00 30 1°C +80+200°C

Guaina inox. - Stainless steel housing.



Termometro per panettiere
Baker's thermometer
Bäckerthermometer
Thermomètre boulanger
Termómetro panadero

art. l. cm. scala range
49712-00 30 1°C -10+60°C

Guaina plastica. - Plastic housing.



P

Termometro per forno, inox
Oven thermometer, stainless steel
Ofenthermometer, 18-10 Edelstahl
Thermomètre à four, inox
Termómetro horno, inox

art. ø cm. scala range
19709-00 7 10°C +38+316°C



Termometro frigo/freezer, ABS
Fridge/freezer thermometer, ABS
Kühlschrankthermometer, ABS
Thermomètre à réfrigérateur, ABS
Termómetro congelador, ABS

art. ø cm. scala range
49885-02 7 1°C -50+50°C



P

Termometro frigo/freezer, inox
Fridge/freezer thermometer, s/s
Kühlschrankthermometer, Edelstahl
Thermomètre à réfrigérateur, inox
Termómetro congelador, inox

art. ø cm. scala range
19702-00 6 1°C -29+27°C



Termometro digitale, ABS
Digital thermometer, ABS
Digitalthermometer, ABS
Thermomètre digitale, ABS
Termómetro digital, ABS

art. dim. cm. scala range
49887-00 1,5x5x7 0,1°C -50+70°C



Termometro da muro
Room/wall thermometer
Wandthermometer
Thermomètre à mur
Termómetro de pared

art. dim. cm. scala range
49702-00 20,5x4 1°C -30+50°C



Termometro da tasca
Pocket thermometer
Taschenthermometer
Thermomètre à poche
Termómetro digital

art. l. cm. scala range
19701-00 15 0,1°C -50+150°C



Termometro digitale
Digital thermometer
Digitalthermometer
Thermomètre digitale
Termómetro digital

art. l. cm. scala range
49710-00 22,5 1°C -50+300°C



P

Termometro da tasca
Pocket thermometer
Taschenthermometer
Thermomètre à poche
Termómetro digital

art.	Ø mm.	scala	range
49701-00	3,5	0,1°C	-50+200°C

Lunghezza sonda 12,5 cm.
Penetration probe 12,5 cm.



Termometro a infrarossi/sonda
Infrared thermometer with probe
Infrarot u. Sonde Thermometer
Thermomètre infrarouge à sonde intégrée
Termómetro infrarrojos con sonda integrada

art.	dim. cm.	scala	range
49985-00	2,5x4x15,6	0,1°C	-32,9+219,9°C IR -54,9+329,9°C TC

Sonda pieghevole inox Ø 3,3 x 120 mm. Batteria litio 3V CR2032, 40 ore. - Stainless steel penetration probe Ø 3,3 x 120 mm. 3V CR2032 lithium coin cell, 40 hours.



Termometro a infrarossi
Infrared thermometer
Infrarot-Thermometer
Thermomètre infrarouge
Termómetro infrarrojo

art.	dim. cm.	scala	range
49986-00	2,5x5,2x10	0,1°C	-49,9+349,9°C

90 gr., batteria AAA 2x1,5V, 20 ore uso continuativo. - 90 grams, battery 2x1.5V AAA, life 20 hours continuous use.



Termometro digitale
Digital thermometer
Digitalthermometer
Thermomètre digital
Termómetro digital

art.	dim. cm.	scala	range
49883-00	13x5,5x2,5	0,1°C	-50+300°C

Involucro ABS con additivi "Biomaster" che aiutano a ridurre la crescita batterica. Sonda alimentare permanente da 13 cm ed 1 mt di cavo PU a spirale. - ABS case that contains "Biomaster", additive to reduce bacterial growth. Supplied with a permanently attached food penetration probe with a 13 cm pointed s/s stem and 1 mt coiled PU lead.



Termometro multifunzione
Multi-function thermometer
Multifunktions-Thermometer
Thermomètre multifonction
Termómetro multifunción

art.	dim. cm.	scala	range
49988-00	3,2x8,6x11,6	0,1°C	-49,9+149,9°C

Visualizza sia le temperature che gli allarmi impostati. Sonda di penetrazione per cibi, in acciaio inox (Ø 3.5 x 125 mm) con cavo PVC da 1 mt e cappuccio sonda. - LCD displays both the temperature and the alarm set temperatures. Each unit is supplied with a pointed, S/S, food penetration probe (Ø 3.5 x 125 mm) with a 1 mt PVC connecting lead and probe cover.



Termometro digitale
Digital thermometer
Elektronisches Thermometer
Thermomètre digital
Termómetro digital

art.	Ø mm.	scala	range
49715-00	3,5	0,1°C	-50+300°C

Lunghezza sonda 12,5 cm.
Penetration probe 12,5 cm.



Termometro digitale
Digital thermometer
Elektronisches Thermometer
Thermomètre digital
Termómetro digital

Batteria litio 2x3V CR2032, 1500 ore, display LCD 14,3 mm., certificato tracciabile di calibrazione incluso. - 2x3V CR2032 lithium coin cell, 1500 hours, display 14.3 mm LCD. FREE traceable certificate of calibration included.

art.	dim. cm.	scala	range	col.	gr.
49880-10	15,3x4,7x1,9	0,1 or 1°C	-49,9+299,9°C	●	97
49880-11	15,3x4,7x1,9	0,1 or 1°C	-49,9+299,9°C	●	97
49880-12	15,3x4,7x1,9	0,1 or 1°C	-49,9+299,9°C	●	97
49880-13	15,3x4,7x1,9	0,1 or 1°C	-49,9+299,9°C	●	97
49880-14	15,3x4,7x1,9	0,1 or 1°C	-49,9+299,9°C	●	97
49880-15	15,3x4,7x1,9	0,1 or 1°C	-49,9+299,9°C	○	97



Termometro digitale
Digital thermometer
Elektronisches Thermometer
Thermomètre digital
Termómetro digital

art.	dim. cm.	scala	range	gr.
49716-00	1,9x7x15,2	0,1°C	-50+300°C	175

Countdown/up 99 ore e 59 min., allarme con volume regolabile a 92dB. Fornito in astuccio con zip completo di sonda di penetrazione. Batteria AAA 2x1,5V, 5000 ore. - Countdown/up 99 hours and 59 min., alarm with adjustable volume to 92dB. Supplied in a zip wallet complete with penetration probe. Battery 2x1.5V AAA, life 5000 hours.

UTENSILI KITCHEN UTENSILS



Timer/termometro da forno
Oven timer/cooking thermometer
Digitalkochalarm
Minuterie digitale
Reloj/termómetro digital

art.	dim. cm.	scala	range
49718-00	13x7,5x2	1°C	0+300°C

Timer 23h 59min 59sec. Allarme acustico. Sonda ad alta temperatura e 2 m. di cavo. Penetrazione sonda 15 cm (ø4 mm). - Count down/up from/to 23h 59m 59 sec. With audible high alarm. Supplied with a high temperature probe and a 2 mt s/s braided lead. Probe insertion 15 cm.



Termometro per sottovuoto
Sous vide cooking thermometer
Vakuüm-Koch-Thermometer
Thermomètre pour cuisson sous-vide
Termómetro cocción al vacío

art.	dim. cm.	gr.
49881-01	2,5x5,6x12,8	130



Range 0,1°C (-99,9+299,9°C), range 1°C (300+372°C). Batteria AAA 3x1,5V, durata minima 5 anni (10.000 ore). Schermo LCD 12 mm. Risposta veloce, raggiunge la temperatura in soli 3 secondi. Ogni kit contiene 1 termometro, 1 sonda per sottovuoto 60 mm., 1 metro di nastro adesivo, astuccio con zip, certificato di calibrazione tracciabile. Range 0.1°C (-99.9+299.9°C), range 1°C (300+372°C). Battery 3x1.5V AAA, life minimum 5 years (10000 hours). Display 12 mm LCD. Fast response, reaches temperature in just 3 seconds. Each kit contains 1 thermometer, 1 Sous Vide needle probe 60 mm., one metre foam/tape, zip pouch, FREE traceable certificate of calibration.



Spatola con termometro
Spatula with thermometer
Rührspaten mit Thermometer
Spatule avec thermomètre
Espátula con termómetro

art.	dim. cm.	range
49729-00	26x4x1,8	-50+300°C



Termometro a infrarossi
Infrared probe thermometer
Infrarot-Thermometer
Thermomètre infrarouge
Termómetro infrarojos

art.	dim. cm.	scala	range	gr.
49884-08	4x6,6x15,5	0,1°C	-64+1.370°C	185

Batteria alcalina 2xAAA, 180 ore uso continuativo. Battery 2xAAA alkaline, life 180h continuous use.



Termometro a infrarossi
Infrared probe thermometer
Infrarot-Thermometer
Thermomètre infrarouge
Termómetro infrarojos

art.	dim. cm.	scala	range
49717-00	17,5x4x7,2	1°C	-50+400°C



Termometro a infrarossi
Infrared thermometer
Infrarot-Thermometer
Thermomètre infrarouge
Termómetro infrarojos

art.	dim. cm.	scala	range	gr.
49987-00	3,6x8,8x13,1	0,1°C	-50+330°C	143

Batteria 9 volt PP3, 80 ore uso continuativo. Con allineamento laser incorporato. - Battery 9 volt PP3, life 80 hours continuous use. The thermometer also incorporates laser assisted alignment.



N

Cucchiaino misuratore volumetrico digitale
Digital volumetric spoon scale
Digitale Volumenöffelwaage
Cuillère à balance volumétrique numérique
Cuchara escala volumétrica digital

art.	l. cm.	ml.
49732-00	23	57-130

Misura peso e volume, precisione 0,1 g. Pesa max. 300 g. Permette di pesare in successione più ingredienti fino ad un totale di 3.000 g. Cucchiaino dosatore con 9 ingredienti programmati. - *Weight and volume measurements. 0.1 g precision. Max weight 300 g. Option to weight added ingredients incrementally up to max. 3.000 g. Spoon scale programmes with 9 most common ingredients.*



Timer digitale, H/M/S
Digital timer
Digitalkochalarm
Minuterie digitale
Timer digital

art.	dim. cm.
49720-00	7x5,5

Timer 23H-59M-59S. Orologio 12H AM/PM. Cronometro. Allarme acustico 80dB. Attacco magnetico. - *Timer 23H-59M-59S. Clock 12H AM/PM. Count down. 80dB audible alarm. Magnetic pad.*



Salinometro + termometro
Salt manager + thermometer
Salzgehalt-Meter + Thermometer
Testeur de salinite + thermometer
Salinometro + termómetro

art.	dim. cm.	gr.
49730-00	3,2x1,6x22,5	54

Per misurare il contenuto di sale di alimenti e liquidi in percentuale (da 0 a 5%). È inoltre in grado di misurare la temperatura (0-100°C). Utilizza due batterie a bottone CR2032. Fornito con cucchiaino dosatore e fiala contenente una concentrazione di cloruro di sodio al 2% per calibrare lo strumento. - *To measure the salt content of foods and liquids in percentage (0 to 5%). Temperature 0-100°C. Supplied with measuring spoon and vial containing sodium chloride, concentration 2% to calibrate the instrument.*



Tester per oli di frittura
Cooking oils tester
Kontrollsystem für Bratenöle
Test des huiles
Controlador de aceite de frituras

art.	dim. cm.	h.
49731-00	24x21	6,5



Sistema per l'autocontrollo dello stato di degradazione degli oli di frittura, attraverso metodo colorimetrico, basato sulla verifica della percentuale dei composti polari. Il kit è sufficiente per effettuare circa 30 controlli. Tempo di risposta 3 minuti circa. Kit fornito in comoda valigetta con foglio istruzioni. - *Self-test system for evaluating the degree of deterioration of heated oils and grases by a colorimetric method based on the percentage of ionic compounds. Around 30 applications per kit. Response time about 3 minutes. Each kit is supplied with carrying case and instructions.*



ORION Orologio da parete
Wall clock
Wanduhr
Horloge à paroi
Reloj de pared

art.	ø cm.
41380-01	29

Metallo satinato, pila alcalina inclusa.
Satin alloy, battery included.



SILENT Orologio da parete
Wall clock
Wanduhr
Horloge à paroi
Reloj de pared

art.	ø cm.
41380-02	30,5

ABS, pila alcalina inclusa. Movimento silenzioso. - *ABS, battery included. Silent clock.*

BILANCE - SCALES



Bilancia digitale
Digital scale
Präzisionswaage
Balance digitale
Balanza digital



art.	dim. cm.	scala	kg.
49865-06	21,6x17,1x6,3	1g	6

Protezione antimicrobica. Conteggio porzioni. Ampia piattaforma cm 4,6x16,5. Schermo angolare LCD. Adattatore AC o batterie. Costruzione in ABS/acciaio inox. *Antimicrobial protection. Portion count. Large and removable platform cm 4,6x16,5. AC adapter or batteries supply. ABS/stainless steel construction.*

Bilancia digitale
Digital scale
Präzisionswaage
Balance digitale
Balanza digital



art.	dim. cm.	scala	kg.
49865-70	30,5x31,8x5,7	100g	68

Piattaforma cm 30,5x30,5. Indicatore batteria scarica. Supporto schermo LCD da 2,5 cm rimovibile per montaggio a parete. Piedini antiscivolo. Alimentazione a corrente o a batteria. - *Platform cm 30,5x30,5. Low battery indicator. Remote LCD wall mount display. Non-slip feet. Electric or batteries supply.*

Bilancia meccanica, inox
Mechanical scale, stainless steel
Waage, Edelstahl Rostfrei
Balance, inox
Balanza, inox

art.	Ø cm.	scala	kg.
49864-03	20	10g	3
49864-05	20	20g	5



Bilancia meccanica, inox
Mechanical scale, stainless steel
Waage, Edelstahl Rostfrei
Balance, inox
Balanza mecánica, inox

art.	ø cm.	scala	kg.
49864-20	25	100g	20



Bilancia meccanica, inox
Mechanical scale, stainless steel
Automatische Waage, Edelstahl Rostfrei
Balance automatique, inox
Balanza mecánica, inox

art.	dim. cm.	scala	kg.
49866-01	18x22	5g	1
49866-02	18x22	10g	2
49866-05	18x22	20g	5



Bilancia digitale
Digital scale
Präzisionswaage
Balance digitale
Balanza digital

art.	dim. cm.	scala	kg.
49863-10	24x18	1,0g	10

3 batterie tipo R14 1,5V (non include).
Alimentatore tipo DC 6V 300mA a richiesta. - 3 batteries type R14 1,5V (not included). Adapter DC 6V 300mA upon request.



Bilancia digitale
Digital scale
Präzisionswaage
Balance digitale
Balanza digital

art.	ø cm.	scala	kg.
49853-01	13	0,5g	1
49853-03	13	1,0g	3

2 batterie tipo AA (non incl.).
2 batteries type AA (not included).



Bilancia digitale
Digital scale
Präzisionswaage
Balance digitale
Balanza digital

art.	dim. cm.	scala	kg.
49863-30	23,5x30	2g	30
49863-50	23,5x30	5g	50



Bilancia digitale
Digital scale
Präzisionswaage
Balance digitale
Balanza digital

art.	dim. cm.	scala	kg.
49863-15	23x29,5x12,5	2g	15

4 batterie tipo LR20 1,5V (non incl.).
4 batteries type LR20 1,5V (not included).



Bilancia da tasca
Pocket scale
Rollenhalter
Balance de poche
Balanza bolsillo

art.	dim. cm.	scala	g.
49852-20	10,6x6,4x4	0,01g	200

Funziona con 2 pile tipo AAA. - Powered by 2 batteries type AAA.



Bilancia digitale
Digital scale
Präzisionswaage
Balance digitale
Balanza digital

art.	dim. cm.	scala	kg.
49863-95	57x32x61	20g	150
49863-99	67,5x42x88	50g	300

IP 51. Funziona con una batteria ricaricabile 6V.
Powered by 6V rechargeable battery.



P SERIE 48280

MANICO POLIPROPILENE
POLYPROPYLENE HANDLE



Un'ampia gamma di utensili professionali per la cucina, indispensabili per creare decorazioni originali e fantasiose, ma utili anche per svolgere le più semplici operazioni in modo preciso e veloce. Tutti i pezzi sono realizzati in acciaio inox 18/10, mentre la manicatura ergonomica è prevista nella versione acciaio inox o polipropilene. Tutti gli articoli sono dotati di un foro sul manico per essere appesi. Lavabili in lavastoviglie. Il design è moderno e funzionale per il massimo comfort d'utilizzo.

A wide range of professional kitchen utensils. These are essential tools to make original decorations as well as to ease the preparation of your recipes. All items are made of 18/10 stainless steel while their ergonomic handles are available both in stainless steel and Polypropylene. They are all hangable and can be cleaned in dishwasher. They boast a modern, functional design and are very easy to use.

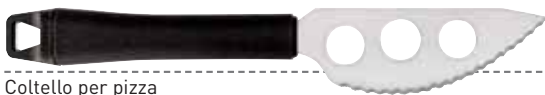

Coltello per pizza
Pizza knife
Pizza-Messer
Couteau à pizza
Cuchillo pizza

art.	l. cm.
48280-45	23,5



Rotella taglia pizza
Pizza wheel
Pizza-Rad
Roulette à pizza
Ruleta cortapizzas

art.	l. cm.	Ø
18324-10	24	10

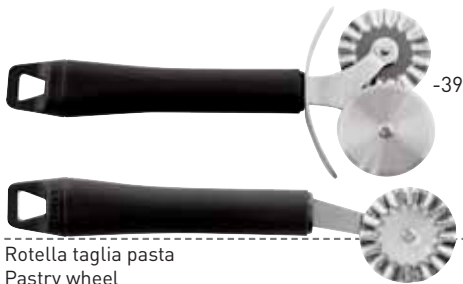

Rotella taglia pasta
Pastry wheel
Teig-Rad
Roulette à pâte
Ruleta cortapasta

art.	l. cm.	Ø
48280-32	18	4
48280-39	18	4



Spelucchino
Paring knife
Spickmesser
Couteau d'office
Cuchillo puntilla

art.	l. cm.
48280-55	21



Coltello verdure
Vegetables knife
Gemüsemesser
Couteau à crudités
Cuchillo verduras

art.	l. cm.
48280-48	19



Coltello bistecca/verdure
Steak/vegetables knife
Steack-/ Gemüsemesser
Couteau à steak/crudités
Cuchillo bisteck/verduras

art.	l. cm.
48280-51	24



Coltello pomodori/limoni
Tomato/lemon knife
Tomaten-/Zitronenmesser
Couteau à tomates/citrons
Cuchillo tomate/limón

art.	l. cm.
48280-58	23,5



Falcetta prezzemolo
Parsley knife
Petersilie-Wiegemesser
Hachinette persil
Cuchillo perejil

art.	l. cm.	Ø
48280-20	17	10,5

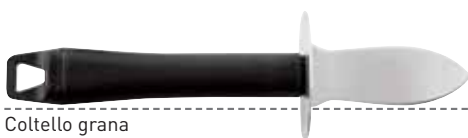

Coltello grana
Cheese knife
Käsemesser
Couteau à fromage
Cuchillo queso

art.	l. cm.
48280-04	20



Coltello apriostriche/cozze
Oyster knife
Austernmesser
Couteau à huîtres
Cuchillo ostras

art.	l. cm.
48280-05	20,5





Coltello castagne
Chestnut knife
Kastanienmesser
Couteau à marrons
Cuchillo castañas

art. l. cm.
48280-21 16



Squamapesce
Fish scaler
Fischentschupper
Ecailleur à poisson
Escamador

art. l. cm.
48280-38 24



Squamapesce doppio
Double fish scaler
Fischentschupper, doppel
Ecailleur à poisson double
Escamador doble

art. l. cm.
48280-37 22,5

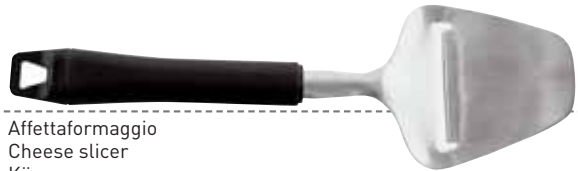

Affettaformaggio
Cheese slicer
Käsemesser
Couteau à fromage
Cuchillo para cortar queso

art. l. cm.
48280-41 25



Affettaformaggio tenero
Cheese slicer
Käsemesser
Couteau à fromage
Cuchillo para queso suave

art. l. cm.
48280-42 20,5



Mannaietta per formaggio
Cheese cleaver
Käsemesser
Couteau à fromage
Hacha para queso

art. l. cm.
48280-49 23,5



Coltello formaggi duri
Cheese knife
Käsemesser
Couteau à fromage
Cuchillo para queso duro

art. l. cm.
48280-56 23,5



Coltello formaggio
Cheese knife
Käsemesser
Couteau à fromage
Cuchillo para queso

art. l. cm.
48280-59 29



Coltello formaggi duri
Parmesan knife
Käsemesser
Couteau à fromage
Cuchillo para queso parmesano

art. l. cm.
48280-46 24



Coltello paté
Foie gras knife
Pastetenmesser
Couteau à foie gras
Cuchillo para paté

art. l. cm.
48280-43 25,5



Coltello tortiera
Pie pan knife
Tortenring-Messer
Couteau à manqué
Cuchillo para tartas

art. l. cm.
48280-22 21



Spalmaßburro
Butter spreader
Butterstreicher
Couteau à tartiner
Cuchillo para untar

art. l. cm.
48280-75 21,5



Pennello
Pastry brush
Kuchenpinsel
Pinceau
Pincel pastelería

art. l. cm.
48280-09 20



Pennello
Pastry brush
Kuchenpinsel
Pinceau
Pincel pastelería

art. l. cm.
48280-94 20



Grattugia formaggio
Ceddar/cheese grater
Käseraffel
Râpe à fromage
Rallador queso

art. l. cm.
48280-06 24

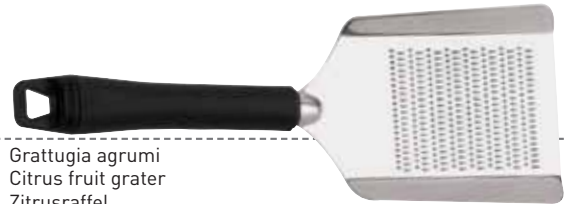

Grattugia agrumi
Citrus fruit grater
Zitrusraffel
Râpe à agrumes
Rallador cítricos

art. l. cm.
48280-07 24



Apribottiglie
Bottle opener
Flaschenöffner
Décapsuleur
Abrebotellas

art. l. cm.
48280-02 20



Apriscatole
Can opener
Dosenöffner
Ouvre boîtes
Abrelatas

art. l. cm.
48280-03 21



Tagliacetrioli
Cucumber knife
Gurkenmesser
Couteau à cornichons
Cortador de pepinillos

art. l. cm.
48280-57 22,5



Temperino per verdure
Vegetable sharpener
Gemüsefedermesser
Taille crayon légumes
Afilador para vegetales

art. ø cm.
48280-12 4,5
48280-13 7,0



Scavino
Melon baller
Kugelausstecher
Moule à pomme
Cortador bolas

art.	l. cm.	ø
48280-24	19,0	1,0
48280-30	19,0	1,5
48280-31	19,0	2,0
48280-35	19,5	2,5
48280-36	19,5	3,0



Scavino doppio
Double melon baller
Kugelausstecher, doppel
Moule à pomme, double
Cortador bolas doble

art.	l. cm.	ø
48280-29	17	1,2-1,8
48280-28	19	2,2-2,8



Scavino ovale
Oval melon baller
Kugelausstecher, oval
Moule à pommes, ovale
Cortador oval

art. l. cm.
48280-26 20



Scavino ovale festonato
Oval melon baller, fluted
Kugelausstecher, oval, gerippt
Moule à pommes, ovale, cannelée
Cortador ovalado

art. l. cm.
48280-27 20



Scavino pomodori
Tomato corer
Tomatenentkerner
Vide-tomates
Vaciador de tomates

art. l. cm.
48280-80 18



Scavazucchine, seghettato
Zucchini corer, dented
Gemüseausstecher
Vide-courgettes
Vaciador de zucchini

art. l. cm.
48280-54 24



Scavino cuore
Heart-shaped melon baller
Kugelausstecher, herz
Moule à pommes, coeur
Cortador forma corazón

art. l. cm.
48280-70 19,5



Levatorsoli a cuore SMALL
Heart-shaped apple corer
Entkerner, herz
Vide-pommes, coeur
Descorazonador forma corazón

art. ø cm. l.
48280-18 2 24



Levatorsoli a cuore LARGE
Heart-shaped apple corer
Entkerner, herz
Vide-pommes, coeur
Descorazonador forma corazón

art. ø cm. l.
48280-19 3 24



Svuota ananas
Pineapple coring tool
Ananasausstecher
Vide ananas
Vacía corazón piña

art. l. cm.
48280-10 25





Pelasparagi
Asparagus peeler
Spargelschäler
Eplucheur à asperges
Pelador de espárrago

art.	l. cm.
48280-85	24



Pelapomodori
Tomato peeler
Tomatenschäler
Eplucheur à tomates
Pelador de tomates

art.	l. cm.
48280-08	18,5



Sbucciatore a lama mobile
Swivel peeler
Pendelschäler
Eplucheur, lame mobile
Pelador con cuchilla mobil

art.	l. cm.
48280-52	21

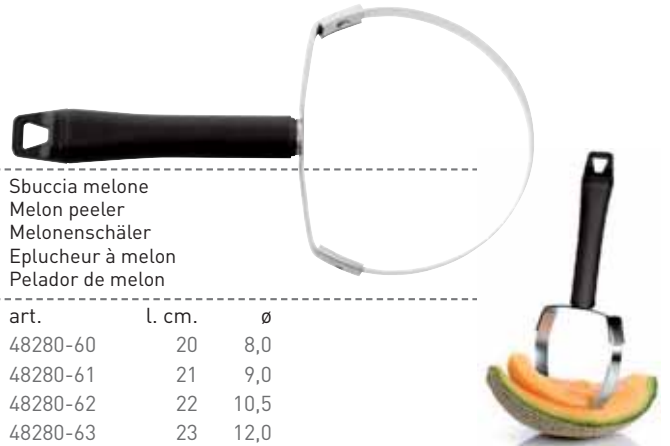

Sbuccia melone
Melon peeler
Melonenschäler
Eplucheur à melon
Pelador de melon

art.	l. cm.	∅
48280-60	20	8,0
48280-61	21	9,0
48280-62	22	10,5
48280-63	23	12,0



Pelapatate
Potato peeler
Sparschäler
Eplucheur
Pelador de patatas

art.	l. cm.
48280-34	20



Sbucciatore a Y
Y-shaped swivel peeler
Pendelschäler
Eplucheur
Pelador forma Y

art.	l. cm.
48280-53	18,5



Pelarance
Orange peeler
Orangenschäler
Eplucheur à oranges
Pelador de naranjas

art.	l. cm.
48280-96	20



Cottello per pompelmo
Grapefruit knife
Grapefruitmesser
Couteau à pamplemousse
Cuchillo para pomelo

art.	l. cm.
48280-47	23



Porzionatore macedonia
Fruit scoop
Fruchtportionierer
Cuiller à fruits
Porcionador de ensalada de frutas

art.	l. cm.
48280-15	20



Cottello bar
Citrus knife
Zitrus-Messer
Couteau à agrumes
Cuchillo para cítricos

art.	l. cm.
48280-97	23,5



Cucchiaio per pompelmo
Grapefruit spoon
Grapefruitlöffel
Cuiller à pamplemousse
Cuchillo para pomelo

art. l. cm.
48280-16 21



Coltello decora frutta
Fruit decorating knife
Dekoriermesser
Couteau à décorer
Cuchillo para decorar fruta

art. l. cm.
48280-91 23



Arricciaburro
Butter curler
Buttermesser
Couteau à beurre
Ruzador de mantequilla

art. l. cm.
48280-11 21,5



Coltello decorare
Decorating knife
Dekoriermesser
Couteau à décorer
Cuchillo para decorar

art. l. cm.
48280-44 22,5



Decoratore
Decorator
Ziseliermesser
Canneleur
Decorador

art. l. cm.
48280-95 16,5



Decoratore per mancini
Decorator, left handed
Ziseliermesser für Linkshänder
Canneleur gaucher
Decorador para zurdos

art. l. cm.
48280-93 16,5



Rigalimoni
Lemon striper
Zesteur
Canneleur
Acanalar de limones

art. l. cm.
48280-90 17



Decoratore triangolo
Lemon striper
Zesteur
Canneleur
Acanalar de limones

art. ø cm. l.
48280-50 2 16



Decora limoni
Lemon striper
Zesteur
Canneleur
Decorador de limones

art. l. cm.
48280-92 17



Tagliaverdure ondulato
Vegetable cutter
Wellenschneider
Coupe légumes, cannelé
Cortador de verduras ondulado

art. l. cm.
48280-23 11,5



Levatorsoli
Apple corer
Entkerner
Vide-pommes
Descorazonador

art. l. cm.
48280-25 23



Taglia juliennes
Julienne cutting knife
Julienneschneidmesser
Couteau à juliennes
Cuchillo para juliennes

art. l. cm.
48286-61 18,5

SERIE 48278 P

MANICO INOX
STAINLESS STEEL HANDLE



Frusta
Whisk
Rührbesen
Fouet
Batidorr

art.	l. cm.	ø
48278-24	27,5	5

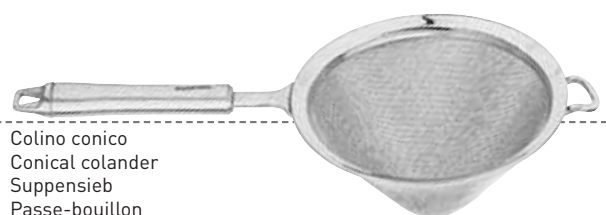

Colino conico
Conical colander
Suppensieb
Passe-bouillon
Colador cónico

art.	l. cm.	ø
48278-13	33	15

UTENSILI KITCHEN UTENSILS



Rotella taglia pizza
Pizza wheel
Pizza-Rad
Roulette à pizza
Ruleta cortapizzas

art.	l. cm.	Ø
48278-33	21	6,7



Rotella taglia pasta
Pastry wheel
Teig-Rad
Roulette à pâte
Ruleta cortapasta

art.	l. cm.	Ø
48278-32	19,5	4



Rotella taglia pasta doppia
Double pastry wheel
Teig-Rad, doppel
Roulette a pâte double
Ruleta cortapasta doble

art.	l. cm.	Ø
48278-39	18,5	4



Affettaformaggio a filo
Wire cheese slicer
Käse-Drahtschneider
Coupe fromage à fil
Cortador de queso a hilo

art.	l. cm.
48278-43	25



Affettaformaggio tenero
Cheese slicer
Käsemesser
Couteau à fromage
Cortador de queso suave

art.	l. cm.
48278-42	21



Coltello verdure
Vegetables knife
Gemüsemesser
Couteau à crudités
Cuchillo de verduras

art.	l. cm.
48278-48	19,5



Squamapesce
Fish scaler
Fischentschupper
Ecailleur à poisson
Escamador

art.	l. cm.
48278-38	22



Mannaietta per formaggio
Cheese cleaver
Käsemesser
Coutau à fromage
Hachita para queso

art.	l. cm.
48278-49	23,5



Spelucchino
Paring knife
Spickmesser
Couteau d'office
Cuchillo moldeador

art.	l. cm.
48278-55	20,5



Coltello parmigiano
Cheese knife
Käsemesser
Coutau à fromage
Cuchillo para queso

art.	l. cm.
48278-46	24



Forca per cipolle
Onion fork
Zwiebelgabel
Fourchette à oignons
Tenedor para cebollas

art.	l. cm.
48278-90	23



Coltello apriostriche/grana
Oyster/cheese knife
Austern-/Käsemesser
Couteau à huîtres/fromage
Cuchillo para ostras/queso

art.	l. cm.
48278-45	20,5



Affettaformaggio
Cheese slicer
Käseraffel
Couteau à fromage
Cortador de queso

art. l. cm.
48278-41 25

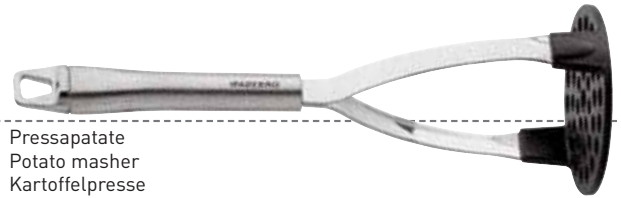

Pressapatate
Potato masher
Kartoffelpresse
Presse-purée
Prensador de patatas

art. l. cm.
48278-87 26



Pressapatate
Potato masher
Kartoffelpresse
Presse-purée
Prensador de patatas

art. l. cm.
48278-31 27



Spatola per glassa
Spatula
Palette
Spatule
Espátula

art. l. cm.
48278-77 32,5



Spalmaburro
Butter spreader
Buttermesser
Couteau à beurre
Cuchillo mantequilla

art. l. cm.
48278-75 21



Pennello pasticceria
Pastry brush
Kuchenpinsel
Pinceau à cuisine
Pincel pastelería

art. l. cm.
48278-94 20



Grattugia
Grater
Raffel
Râpe
Rallador

art. l. cm.
48278-20 28,5

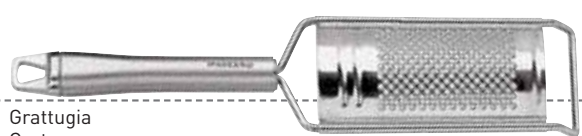

Grattugia
Grater
Raffel
Râpe
Rallador

art. l. cm.
48278-21 20



Spremiaglio
Garlic press
Knoblauchpresse
Presse-ail
Prensador de ajo

art. l. cm.
48278-37 19,5



Apribottiglie
Bottle opener
Flaschenöffner
Ouvre-bouteilles
Abrebotellas

art. l. cm.
48278-02 20,5



Apribarattoli
Can opener
Dosenöffner
Ouvre-boîtes
Abrelatas

art. l. cm.
48278-01 25



Apriscatole
Can opener
Dosenöffner
Ouvre-boîtes
Abrelatas

art. l. cm.
48278-03 21



Scavazucchine, seghettato
Zucchini corer, dented
Gemüseausstecher
Vide-courgettes
Vaciador de zucchini, dentado

art. l. cm.
48278-54 24



Pelapatate
Potato peeler
Kartoffelschäler
Eplucheur
Pelador de patatas

art. l. cm.
48278-34 19,5



Sbucciatore a lama mobile
Swivel peeler
Pendelschäler
Eplucheur
Pelador a cuchilla mobile

art. l. cm.
48278-52 21



Scavino sferico
Melon baller
Kugelausstecher
Moule à pommes
Vaciador

art. l. cm. Ø
48278-35 18 2,5



Sbucciatore a Y
Y-shaped swivel peeler
Pendelschäler
Eplucheur
Pelador forma Y

art. l. cm.
48278-53 18



Pelarance
Orange peeler
Orangenschäler
Eplucheur à pamplemousse
Pelador de naranja

art. l. cm.
48278-96 20



Levatosoli
Apple corer
Entkerner
Vide-pomme
Descorazonador

art. l. cm.
48278-25 23



Coltello per pompelmo
Grapefruit knife
Orangenschäler
Couteau à pamplemousse
Cuchillo para pomelo

art. l. cm.
48278-47 24



Forchettina 3 punte
Potato fork
Gabelchän
Petite fourchette
Tenedor tre puntas

art. l. cm.
48278-17 17



Porzionatore gelato
Ice cream scoop
Eisportionierer
Cuillère à glace
Porcionador para helado

art. l. cm. Ø
48278-95 22 4



Dosa caffè
Coffee measuring spoon
Maßlöffel
Cuillère à mesure
Porcionador de café

art. l. cm. Ø
48278-16 20 3,5



Separauova
Egg separator
Eier-Trenner
Sépare oeufs
Separador de huevos

art. l. cm.
48278-36 22,5



Coltello decora frutta
Decorating knife
Dekoriermesser
Couteau à décorer
Cuchillo para decorar frutas

art.	l. cm.
48278-91	22,5



Cucchiaino cocktail
Cocktail spoon
Cocktaillöffel
Cuiller à cocktail
Cuchara cóctel

art.	l. cm.	Ø
48278-15	24	5



Colino
Soup strainer
Suppensieb
Passe-bouillon
Colador

art.	l. cm.	Ø
48278-12	23	7



Decora limoni
Lemon striper
Zesteur
Canneleur
Decorador de limones

art.	l. cm.
48278-92	16,5



Arricciaburro
Butter curler
Buttermesser
Couteau à beurre
Ruzador de mantequilla

art.	l. cm.
48278-11	21,5



Saponetta toglia odori
Smell-remover soap
Geruchentferner-Seife
Savonette enlève odeurs
Jabon quita olores

art.	l. cm.
48278-99	8

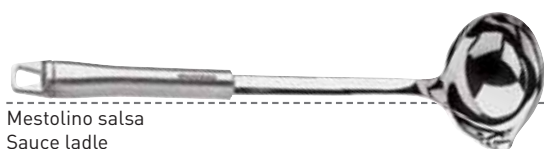

Mestolino salsa
Sauce ladle
Saucenlöffel
Louche à sauce
Cacillo salsa

art.	l. cm.	Ø
48278-68	30	7

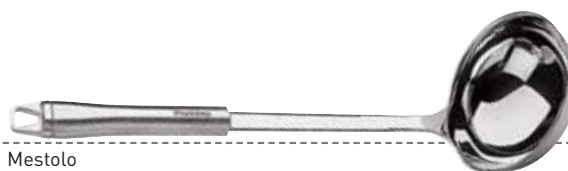

Mestolo
Ladle
Schöpföffel
Louche
Cazo

art.	l. cm.	Ø
48278-69	32	9

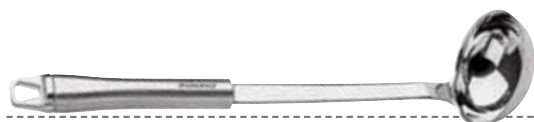

Mestolino
Small ladle
Schöpföffel, klein
Petite louche
Cacillo

art.	l. cm.	Ø
48278-66	29,5	6,5

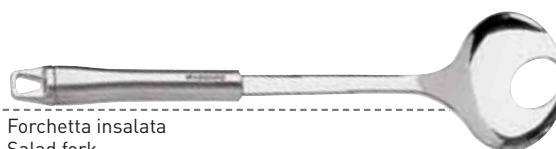

Forchetta insalata
Salad fork
Saltgabel
Fourchette à salade
Tenedor para ensaladas

art.	l. cm.
48278-64	31

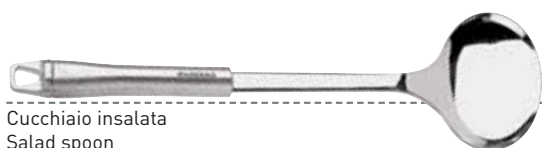

Cucchiaino insalata
Salad spoon
Salatlöffel
Cuiller à salade
Cuchara para ensaladas

art.	l. cm.
48278-62	30,5



Paletta flessibile
Flexible turner
Küchenwender
Pelle
Espátula flexible

art.	l. cm.
48278-70	34

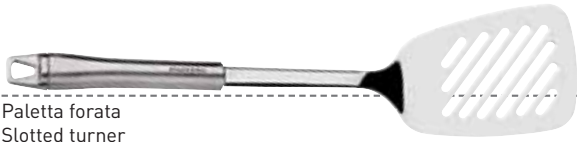

Paletta forata
Slotted turner
Küchenwender
Pelle ajourée
Espátula perforada

art. l. cm.
48278-71 33,5

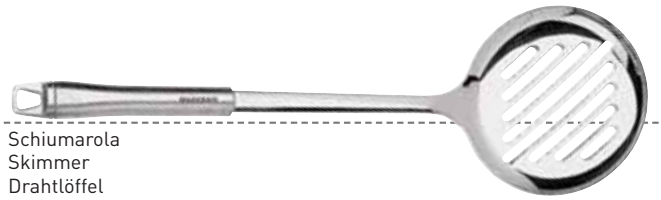

Schiumarola
Skimmer
Drahtlöffel
Ecumoir
Espumadera

art. l. cm. ø
48278-73 36 11



Spatola
Spatula
Palette
Spatule
Espátula

art. l. cm.
48278-76 30

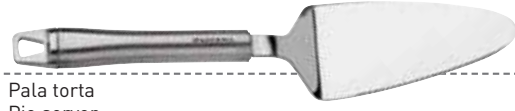

Pala torta
Pie server
Tortenheber
Pelle à gâteau
Paleta para tartas

art. l. cm.
48278-93 27



Paletta pesce/asparagi
Fish/asparagus turner
Palette für Fisch u. Spargeln
Pelle à poisson/asperges
Pala pescado/espárragos

art. l. cm. dim.
48278-72 31,5 20x7,5



Cucchiaio forato
Perforated spoon
Gießlöffel, perforiert
Cuiller perforé
Cuchara perforada

art. l. cm.
48278-61 34,5

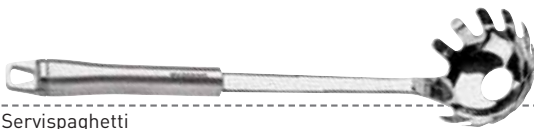

Servispaghetti
Spaghetti server
Spaghettilöffel
Cuiller à spaghetti
Servidor para espagueti

art. l. cm.
48278-74 31,5



Forchettone
Fork
Gabel
Fourchette
Tenedor

art. l. cm.
48278-65 33,5



Cucchiaio risotto
Rice spoon
Reislöffel
Rice spoon
Cuchara para risotto

art. l. cm.
48278-63 26



Pala pasticcio
Lasagne spatula
Palette
Pelle
Pala para pastel

art. l. cm.
48278-27 28

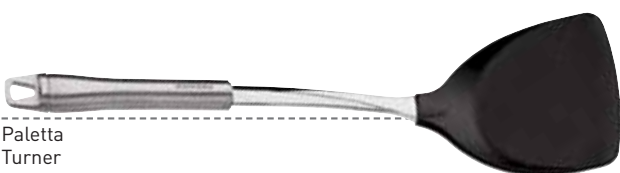

Paletta
Turner
Palette
Pelle
Paleta

art. l. cm.
48278-86 35



Paletta forata
Perforated turner
Küchenwender, perforiert
Pelle ajourée
Pala perforada

art. l. cm.
48278-85 36

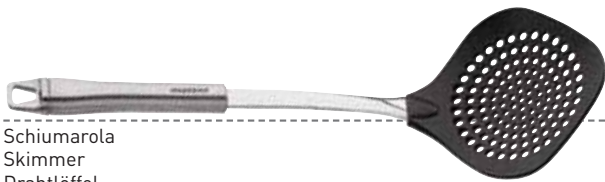

Schiumarola
Skimmer
Drahtlöffel
Ecumoir
Espumadera

art. l. cm.
48278-88 35,5

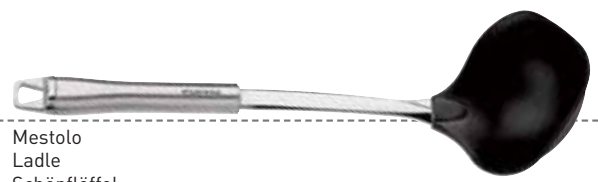

Mestolo
Ladle
Schöpföffel
Louche
Cazo

art. l. cm.
48278-84 32



Cucchiaio riso
Rice spoon
Giesslöffel
Cuiller
Cuchara

art. l. cm.
48278-82 34,5



Cucchiaio forato
Perforated spoon
Giesslöffel, perforiert
Cuiller ajouré
Cuchara perforada

art. l. cm.
48278-81 34,5



Servispaghetti
Spaghetti server
Spaghettillöffel
Cuiller à spaghetti
Servidor para espagueti

art. l. cm.
48278-89 34,5



Forchettone
Meat fork
Gabel
Fourchette
Tenedor

art. l. cm.
48278-83 34



Cucchiaio silicone
Silicone spoon
Löffel aus Silikon
Cuiller en silicone
Cucharón de silicona

art. l. cm. dim.
48278-14 29,5 5,5x8



Paletta silicone
Silicone turner
Palette aus Silikon
Pelle en silicone
Paleta de silicona

art. l. cm. dim.
48278-29 25,5 3,5x5,5
48278-28 30,0 5x9

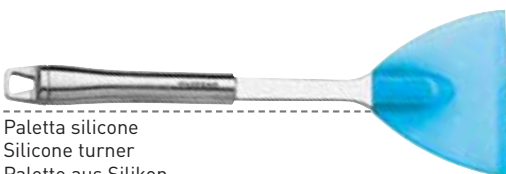

Paletta silicone
Silicone turner
Palette aus Silikon
Pelle en silicone
Paleta de silicona

art. l. cm. dim.
48278-30 27,5 9x7



Sbattitore burro
Butter beater
Schäber
Spatule
Batidor para mantequilla

art. l. cm.
48278-26 31



Frusta per uova
Egg whisk
Rührbesen
Fouet
Batidor

art. l. cm.
48278-18 21

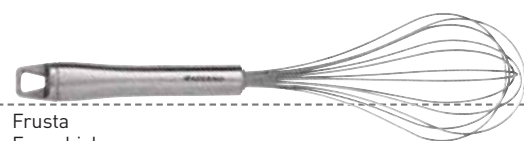

Frusta
Egg whisk
Rührbesen
Fouet
Batidor

art. l. cm.
48278-19 28,5

CUCINA ETNICA *ETHNIC CUISINE*



ZEN



Una serie di ciotole dal chiaro design orientaleggiate create per servire dalla colazione alla cena. Una varietà di gusci funzionali e versatili, perfetti per presentare i più diversi alimenti alla moda, monoporzioni, fingerfood e specialità asiatiche, in puro gusto estetico.

A series of bowls in clear oriental design perfect for serving from breakfast through dinner. A variety of functional and versatile items which enable to serve any types of cuisine and can be mixed with plain white items of other shapes. Any fashion food served in a simple and pure aesthetic style.



Ciotola, melamina
Bowl, melamine
Schüssel, Melamin
Bol, melamine
Bol, melamine

art.	dim. cm.	h.	col.
44450-21	21x21	11	○
44450B21	21x21	11	●



Ciotola, melamina
Bowl, melamine
Schüssel, Melamin
Bol, melamine
Bol, melamine

art.	dim. cm.	h.	col.
44450-12	12x12	4	○
44450B12	12x12	4	●



Ciotola, melamina
Bowl, melamine
Schüssel, Melamin
Bol, melamine
Bol, melamine

art.	dim. cm.	h.	col.
44450-17	17,5x17,5	7	○
44450B17	17,5x17,5	7	●



Ciotola, melamina
Bowl, melamine
Schüssel, Melamin
Bol, melamine
Bol, melamine

art.	dim. cm.	h.	col.
44450-11	11x10	3	○
44450B11	11x10	3	●



Ciotola, melamina
Bowl, melamine
Schüssel, Melamin
Bol, melamine
Bol, melamine

art.	dim. cm.	h.	col.
44450-13	13x11	3,5	○
44450B13	13x11	3,5	●



Ciotola, melamina
Bowl, melamine
Schüssel, Melamin
Bol, melamine
Bol, melamine

art.	dim. cm.	h.	col.
44450-15	17,5x15,5	5,5	○
44450B15	17,5x15,5	5,5	●



Piatto, melamina
Dish, melamine
Platte, Melamin
Plat, melamine
Bandeja, melamine

art.	dim. cm.	h.	col.
44450-23	22x23,5	5,5	○
44450B23	22x23,5	5,5	●



Vassoio, melamina
Tray, melamine
Tablett, Melamin
Plateau, melamine
Bandeja, melamine

art.	dim. cm.	h.	col.
44451-23	22,5x9,5	3	○
44451B23	22,5x9,5	3	●



Vassoio, melamina
Tray, melamine
Tablett, Melamin
Plateau, melamine
Bandeja, melamine

art.	dim. cm.	h.	col.
44451-22	22x12	3	○
44451B22	22x12	3	●

CUCINA ETNICA ETHNIC CUISINE



Ciotola, melamina
Bowl, melamine
Schüssel, Melamin
Bol, melamine
Bol, melamine

art.	ø cm.	h.	col.
44452-31	31	8,5	○
44452B31	31	8,5	●



Ciotola, melamina
Bowl, melamine
Schüssel, Melamin
Bol, melamine
Bol, melamine

art.	dim. cm.	h.	col.
44453-14	14,5x12	5,5	○
44453B14	14,5x12	5,5	●



Ciotola, melamina
Bowl, melamine
Schüssel, Melamin
Bol, melamine
Bol, melamine

art.	ø cm.	h.	col.
44454-11	11,5	4	○
44454B11	11,5	4	●



Ciotola, melamina
Bowl, melamine
Schüssel, Melamin
Bol, melamine
Bol, melamine

art.	dim. cm.	h.	col.
44455-09	9x7	2,5	○
44455B09	9x7	2,5	●



Ciotola, melamina
Bowl, melamine
Schüssel, Melamin
Bol, melamine
Bol, melamine

art.	dim. cm.	h.	col.
44456-14	14x9	2,5	○
44456B14	14x9	2,5	●



Ciotola, melamina
Bowl, melamine
Schüssel, Melamin
Bol, melamine
Bol, melamine

art.	dim. cm.	h.	col.
44457-32	32,5x14	4	○
44457B32	32,5x14	4	●



Piatto tondo, melamina
Round dish, melamine
Platte, rund, Melamin
Plat rond, melamine
Bandeja redonda, melamine

art.	ø cm.	h.	col.
44459-28	28	3	○
44459B28	28	3	●



Vassoio, melamina
Tray, melamine
Tablett, Melamin
Plateau, melamine
Bandeja, melamine

art.	dim. cm.	h.	col.
44461-20	20x20	4,5	○
44461B20	20x20	4,5	●



Vassoio, melamina
Tray, melamine
Tablett, Melamin
Plateau, melamine
Bandeja, melamine

art.	dim. cm.	h.	col.
44462-25	25x25	5,5	○
44462B25	25x25	5,5	●



Vassoio, melamina
Tray, melamine
Tablett, Melamin
Plateau, melamine
Bandeja, melamine



art.	dim. cm.	h.
44464-23	23,5x7,5	2



Vassoio, melamina
Tray, melamine
Tablett, Melamin
Plateau, melamine
Bandeja, melamine



art.	dim. cm.	h.
44465-24	24,5x6,5	1,5



Vassoio, melamina
Tray, melamine
Tablett, Melamin
Plateau, melamine
Bandeja, melamina

art.	dim. cm.	h.	col.
44460-24	24x12,5	2	○
44460B24	24x12,5	2	●



Coppa riso, melamina
Rice bowl, melamine
Reistasse, Melamin
Bol à riz, melamine
Copa arroz, melamina

art.	ø cm.	h.	lt.
44463-11	11	7	0,3



Ciotola brodo, melamina
Soup bowl, melamine
Suppentasse, Melamin
Bol à soup, melamine
Bol sopa, melamina

art.	ø cm.
49640-09	9



Coppa riso, melamina
Rice bowl, melamine
Reistasse, Melamin
Bol à riz, melamine
Copa arroz, melamina

art.	ø cm.
49641-12	11



Cucchiaio, melamina
Spoon, melamine
Löffel, Melamin
Cuiller, melamine
Cucharita, melamina

art.	l. cm.
49644-00	13



Zuppiera con coperchio, melamina
Soup bowl with cover, melamine
Suppenterrine mit Deckel, Melamin
Soupière avec couvercle, melamine
Sopera con tapa, melamina

art.	ø cm.
49645-25	25,4



Cucchiaione a servire, melamina
Serving spoon, melamine
Servierlöffel, Melamin
Cuillère à servir, melamine
Cuchara para servir, melamina

art.	l. cm.
49644-22	22



Zuppiera, melamina
Soup bowl, melamine
Suppenterrine, Melamin
Soupière, melamine
Sopera, melamina

art.	ø cm.
49647-15	15,2
49647-18	18,0
49647-20	20,3
49647-23	23,0
49647-25	25,4



Piatto tondo, melamina
Round dish, melamine
Runde Schale, Melamin
Plat rond, melamine
Plato redondo, melamina

art.	ø cm.
49648-15	15,2
49648-18	18,0
49648-20	20,3
49648-23	23,0
49648-25	25,4
49648-36	35,5
49648-40	40,6



Piatto ovale, melamina
Oval dish, melamine
Platte, oval, Melamin
Plat oval, melamine
Plato oval, melamina

art.	ø cm.
49649-20	20,3
49649-23	23,0
49649-25	25,4
49649-30	30,5
49649-36	35,5
49649-40	40,6



Piatino salsa, melamina
Sauce dish, melamine
Saucenteller, Melamin
Assiette à sauce, melamine
Platillo para salsa, melamina

art.	ø cm.
49642-07	7
49642-09	9



Piattino 2 scomparti, melamina
Double dish, melamine
Doppel-Schale, Melamin
Plat double, melamine
Platillo doble, melamina

art. dim. cm.
49643-02 8,5x7



Cucchiaio brodo, melamina
Soup spoon, melamine
Suppenlöffel, Melamin
Cuiller à soupe, melamine
Cuchara sopa, melamina

art. l. cm.
49655-35 14



Ciotola brodo/riso, melamina
Soup/riso bowl, melamine
Suppentasse-/Reisschüssel, Melamin
Bol à soupe/riz, melamine
Bol sopa/arroz, melamina

art. ø cm.
49655-34 11

Zuppa di miso è una zuppa tradizionale giapponese, ci sono molti modi per prepararla, la versione base è costituita da un brodo chiamato "dashi" in cui viene ammorbidita la pasta di miso, alga Wakame, zenzero e erba cipollina. Molti ingredienti vengono aggiunti in base alle ricette regionali e stagionali e le preferenze personali. - *Miso soup is a traditional Japanese soup consisting of a stock called "dashi" into which softened miso paste is mixed. Many ingredients are added depending on regional and seasonal recipes, and personal preferences.*



Piatto a servire
Sushi serving dish
Sushi-Servierteller
Plat à sushi
Plato para sushi

art. ø cm.
49655-21 22
49655-22 25
49655-23 28



Perfetto per servire sushi o cirashi, una delle preparazioni tradizionali del sushi giapponese. La base è sempre il classico riso cotto che si sposa a meraviglia con il pesce crudo. Nel cirashi solitamente si utilizzano pesci carnosi come tonno, salmone, sgombrò, spada, ricciola e gamberi che si servono sopra il riso. - *This sushi oke dish offers the perfect presentation for chirashi recipes. Chirashi is one of the traditional dishes of the Japanese sushi. The base is always the classic cooked rice perfect with the raw fish such as tuna, salmon, mackerel, sword, yellowtail and shrimps.*



Vassoio bento
Bento tray
Bento-Platte
Plateau à bento
Bandeja bento

art. dim. cm. h.
49655-36 22x15 3



Scatola bento
Bento box
Bento-Box
Boîte à bento
Caja bento

art. dim. cm. h.
49655-37 25x25 5



Piatto presentazione sushi boat
Sushi Boat presentation platter
Sushischiffchen
Bateau présentation sushi
Barco presentación sushi

art. dim. cm. h.
49655-29 38x15 8



Tagliere sushi, PP
Sushi Board, PP
Sushibrett, PP
Planche à sushi, PP
Tabla para sushi, PP

art. dim. cm.
49655-13 18x11,5



Vassoio reversibile
Double Sided Tray
Platte
Plateau
Bandeja

art. dim. cm.
49655-20 35x31

Vassoio nero/rosso, mezzaluna, reversibile. Perfetto come segnaposto, come tovaglietta, per servire zuppe, insalate o in combinazione con piatti più piccoli per servire sushi o antipasti. - *Black and red reversible "half moon" tray. Perfect for place setting as a placemat, to serve soup, salad, or an entire meal, or in conjunction with smaller plates to serve sushi or appetizers.*

Pezzo a servire noto come geta per la sua somiglianza agli elevati sandali giapponesi in legno, un perfetto complemento sushi bar, e anche una bella base per aperitivi o dessert. - *Service piece known as geta for its resemblance to the elevated wooden Japanese sandals, a perfect addition to the sushi bar service, also creates a beautiful canvas for tapas and desserts.*



Tagliere sushi, bamboo
Bamboo Sushi Board Geta
Bambus-Sushibrett,
Planche à sushi en bambou
Tabla para sushi de bambù

art. dim. cm. h.
49655-24 24x15 3



Padella Toban
Toban skillet
Toban-Pfanne
Poêle Toban
SarténToban

art. ø cm.
49655-40 19



Per cucinare al salto, in forno, microonde, ecc., oltre ad essere uno strumento di cottura si utilizza per servire direttamente in tavola. Toban (traduzione letterale "padella ceramica"), è una padella tradizionale giapponese utilizzata anche come piatto. - *Steak, stir-fry, quick suki-yaki, oven-baking, or even microwave cooking etc., Iga-yaki toban (donabe skillet) is a unique cookware as well as a serving dish at the same time. Toban (literally translates into "ceramic skillet"), is one of traditional-style Japanese cookware which can work as skillet or shallow pot.*



Piatto presentazione sushi bridge
Sushi bridge presentation platter
Sushi-Bridge
Plat de présentation sushi bridge
Plato de presentación sushi bridge

art. dim. cm. h.
49655-41 28x13,5 6



Supporto per temaki, legno
Wooden hand roll stand
Temaki-Ständer, Holz
Support pour temaki, bois
Soporte para temaki, madera

art. dim. cm. h.
49655-31 18x9 8,5



Supporto per temaki, laccato
Hand roll stand, laquered
Temaki-Ständer
Support pour temaki
Soporte para temaki

art. dim. cm. h.
49655-32 18x9,5 8



Perfetto per la presentazione del temaki. Contiene fino a tre pezzi. Temaki sushi è un tipo di sushi arrotolato a forma di cono. Il temaki è diverso dal sushi maki in quanto non si taglia a pezzi. La traduzione di "temaki" è arrotolato a mano. - *Holds up to three pieces. Temaki sushi is a form of rolled sushi, created in a cone. Temaki is different from maki sushi, as you do not cut it into pieces. "Temaki" means hand roll.*



Caraffa sake, porcellana
Sake jug, porcelain
Sakekrug, Porzellan
Carafe à sake, porcelaine
Jarra sake, porcelana

art. ø cm. h. ml.
49655-25 6 13 170



Coppetta sake, porcellana
Sake cup, porcelain
Sakebecher, Porzellan
Coupe à sake, porcelaine
Copa sake, porcelana

art. ml.
49655-26 40



Supporto bacchette cinesi, porcellana
Chopstick rest, porcelain
Stäbchen-Aufsteller, Porzellan
Support à baguettes, porcelaine
Soporte para palillos, porcelana

art. dim. cm.
49655-28 4,5x3

CUCINA ETNICA ETHNIC CUISINE



Supporto bacchette cinesi, porcellana
Chopstick rest, porcelain
Stäbchen-Aufsteller, Porzellan
Support à baguettes, porcelaine
Soporte para palillos, porcelana

art. dim. cm.
49655-27 4,5x3

Bacchette, melamina
Chopsticks, melamine
Esstäbchen, Melamin
Baguettes, melamine
Palillos, melamina

art. l. cm. paia/pairs
49658-01 27 10



Bacchette, melamina
Chopsticks, melamine
Esstäbchen, Melamin
Baguettes, melamine
Palillos, melamina

art. l. cm. paia/pairs
49658-02 27 10

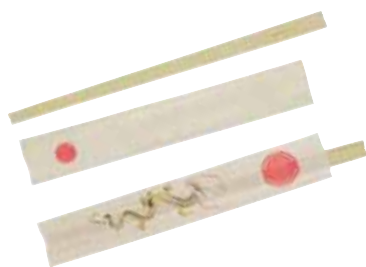

Bacchette, bamboo, monouso
Bamboo chopsticks, disposable
Bambus Esstäbchen
Baguettes en bambou
Palillos de bambú

art. l. cm. paia/pairs
48300-29 21 100

Bacchette, bamboo, monouso
Bamboo chopsticks, disposable
Bambus Esstäbchen
Baguettes en bambou
Palillos de bambú

art. l. cm. paia/pairs
48300-30 24 50

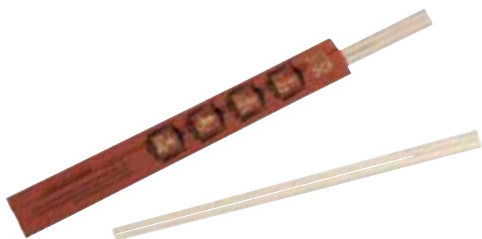

Bacchette, bamboo, monouso
Bamboo chopsticks, disposable
Bambus Esstäbchen
Baguettes en bambou
Palillos de bambú

art. l. cm. paia/pairs
49627-22 24 100

Fornite a coppie unite, in un sacchetto di carta. - Supplied in pairs, attached together, in a paper packet.

Spiedini bamboo, monouso
Bamboo skewers, disposable
Bambus-Fleischspieß
Brochettes en bambou
Palillos de bambú

art. l. cm. u. pack
48300-31 10,5 200

Spiedini bamboo, monouso
Bamboo skewers, disposable
Bambus-Fleischspieß
Brochettes en bambou
Palillos de bambú

art. l. cm. u. pack
48300-32 10,5 200
48300-33 15,0 100



La parola giapponese per le bacchette "Hashi" significa "ponte". A differenza delle bacchette cinesi, che sono squadrate e nella parte terminale smussate, quelle giapponesi sono arrotondate e rastremate all'estremità (molto più difficili da usare). Questo sembra per facilitare la rimozione delle lisce dal pesce alla base della dieta giapponese. - *The Japanese word for chopsticks "Hashi" means "bridge". Unlike Chinese chopsticks, which are squared-off and blunt at the end, these Japanese utensils are rounded and tapered to a point at the end (much more difficult to use). It has been suggested that this is in order to facilitate the removal of bones from fish, which makes up a great part of the Japanese diet.*



Bacchette giapponesi, colori assortiti
Japanese chopsticks, assorted colors
Japanische-Esstäbchen
Baguettes japonaises
Palillos japoneses

art. l. cm.
49628-00 24

Bacchette giapponesi, inox
Japanese chopsticks (hashi), s/s
Japanische-Esstäbchen, E.R.
Baguettes japonaises, inox
Palillos japoneses, inox

art. l. cm.
49655-30 23

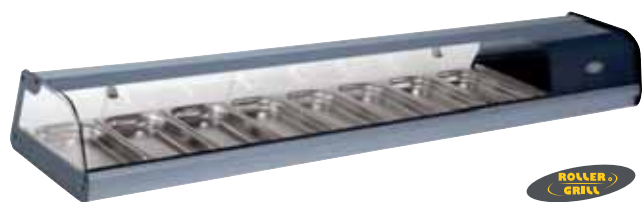

ROLLER GRILL

Costruzione in acciaio inox e finitura in alluminio anodizzato. Porte posteriori scorrevoli in plexi, rimovibili, vetro frontale curvo, sollevabile. Dispositivo di scarico, interruttore on/off, interruttore LED, compressore, condensatore ed evaporatore, termostato elettronico, gas T134 privo di CFC. Temperatura: +1°C/+5°C. Dotazione: 6/8 contenitori GN 1/3 altezza 40 mm. - *Stainless steel construction and finishing in anodized aluminum. Removable rear sliding doors in plexi, liftable curved front glass. Draining device, on/off switch, LED switch, compressor, condenser and evaporator, electronic thermostat, gas T134 CFC free. Temperature: +1°C/+5°C. Delivered with 6/8 GN 1/3 containers, height 40 mm.*



Vetrina antipasti
Tapas display
Vorspeisen-Schaufenster
Vitrine tapas
Vitrina para tapas

art.	dim. cm.	h.	temp.	V	W	kg
49630-06	145x40	26	+2/+5°C	230	160	33
49630-08	180x40	26	+2/+5°C	230	160	40



Stuoietta bamboo
Bamboo sushi mat
Bambus-Sushi-Matte
Tapis à sushi, bambou
Mantelín de bambù para sushi

art.	dim. cm.
49626-00	24x24

Stuoietta bamboo
Bamboo sushi mat
Bambus-Sushi-Matte
Tapis à sushi, bambou
Mantelín de bambù para sushi

art.	dim. cm.
49626-02	24x21



Tappetino per sushi, silicone
Sushi mat, silicone
Sushi-Rollen Matte, Silikon
Natte à rouler le sushis, silicone
Mantelín para sushi, silicona

art.	dim. cm.
49655-11	25x26



Kit per sushi-maki
Sushi maki set
Sushi-Maki-Satz
Utensile pour sushis-maki
Juego para sushi-maki

art.	ø cm.	l.
49655-01	6	30

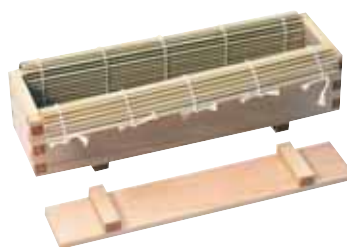

Kit 3 pz per sushi-maki
Sushi-maki set 3 pcs
Sushi-Maki-Satz 3 Stk
Kit 3 pcs pour réaliser les sushi-maki
Juego 3 pz para sushi-maki

art.	dim. cm.	h.
49655-02	26x7,5	5,5



Stampo per sushi
Sushi roll mould
Sushi-Ausstechform
Moule à sushi
Molde para sushi

art.	sushi dim. cm.	pcs
49655-08	5x2,5	10



Stampo per onigiri
Onigiri mould
Onigiri-Ausstechform
Moule à onigiri
Molde para onigiri

art.	dim. cm.
49655-14	6x7



Stampo per maki
Maki roll mould
Maki-Ausstechform
Moule à maki
Molde para maki

art.	dim. cm.	h.
49655-10	20x3	3



Stampo per nigiri
Nigiri mould
Nigiri-Ausstechform
Moule à nigiri
Molde para nigiri

art.	dim. cm.
49655-16	5,5x3



Cucchiaio riso
Rice spoon
Reislöffel
Cuiller à riz
Cuchara arroz

art. dim. cm.
49655-03 15x5,3



Cuocivapore, bamboo
Bamboo steamer
Dampf-Kocher, Bambus
Cuiseur à vapeur, bambou
Vaporera bambú redonda

art. ø cm.
49603-15 16
49603-20 20
49603-25 25
49603-30 30
49603-40 40
49603-50 50

2 ceste + 1 coperchio. - 2 bodies + 1 cover.



Cuocivapore quadrato, bamboo
Square bamboo steamer
Dampf-Kocher, Bambus
Cuiseur à vapeur carré, bambou
Vaporera bambú cuadrada

art. dim. cm.
49656-15 15,2x15,2
49656-16 16,5x16,5
49656-20 20,3x20,3



Cuoci riso a vapore
Rice steamer
Reiskocher
Cuit riz
Olla para riz

art. ø cm. h. lt. V W Kg riso/rice
49954-21 50 35 21 220 3000 10



Vaporiera, inox
Steamer, stainless steel
Dampfer, Edelstahl Rostfrei
Cuit vapeur, inox
Olla para cocinar al vapor, inox

art. ø cm. h. kg. V W lt.
49954-18 38 46 7 230 2000 15



Wok c/griglia e coperchio, 3-ply
Wok with grid and cover, 3-ply
Wok mit Rost und Deckel, 3-ply
Wok avec grille et couvercle, 3-ply
Wok con rejilla y tapa, 3-ply

art. ø cm. h.
12529-32 32 8



Wok, ferro
Steel wok pan
Wok-Eisenpfanne
Poêle chinoise, acier
Wok, hierro

art. ø cm. h.
11713-32 32 10
11713-40 40 11



Wok, ferro
Steel wok pan
Wok-Eisenpfanne
Poêle chinoise, acier
Wok, hierro

art. ø cm. h.
49604-31 30,5 9
49604-36 35,5 11
49604-41 40,5 12



Wok antiaderente
Non stick wok
Wok-Pfanne, nichtaftend
Poêle chinoise, anti-adhérente
Wok, antiadherente

art. ø cm.
49612-30 30,5
49612-33 33,0

Wok a fondo piano, antiaderenti, che formano a poco a poco sulla superficie una pellicola antiaderente. Manico legno.
Flat bottom non-stick woks, which gradually builds up a non-stick surface. Wooden handle.

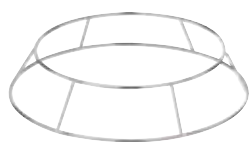

Base per wok, cromata
Wok stand, chromed
Fuss für Wokpfanne, verchromt
Base pour wok, chromée
Base para Wok, cromada

art.	ø cm.	h.
49600-00	20-25	5,5

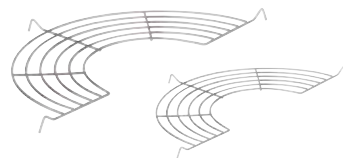

Griglia per tempura, cromata
Tempura rack, chromed
Tempura-Rost, verchromt
Grille à tempura, chromée
Rejilla para tempura, cromada

art.	ø. cm.
49613-30	30,5
49613-33	33,0
49613-35	35,5

La griglia sul wok mantiene in caldo il cibo che ha terminato la cottura, mentre l'olio cola nel wok. - The tempura rack attached to the wok holds food that has finished cooking, so that it stays warm while oil drains back into the wok.



La tempura è un piatto tipico della cucina giapponese che consiste in un fritto croccante e leggero, fatto di verdure e pesce. Il nome deriva dal termine latino "tempora" che indica quattro periodi dell'anno corrispondenti alle quattro stagioni; in questi frangenti di tempo i cristiani evitavano di mangiare carne, nutrendosi solo di pesce e verdure. Si narra che, durante il XVI secolo, alcuni missionari portoghesi giunsero sino in Giappone e qui fecero conoscere al popolo del Sol Levante la tradizione dei tempora; consuetudine che fu poi personalizzata dai giapponesi che iniziarono a friggere verdure e pesce con una pastella leggera. - The tempura is a typical Japanese dish consisting in fried vegetables and fish, crispy and light. The name of this food comes from the Latin term "tempora" indicating four periods of the year corresponding to the four seasons during which Christians abstain from eating meat, eating only fish and vegetables. The story goes that during the sixteenth century, Portuguese missionaries arrived in Japan and taught the people of the Rising Sun the tradition of tempura. Later on this dish has been customized by the Japanese who began to fry vegetables and fish with a light batter.



Wok, ferro
Steel wok pan
Wok-Eisenpfanne
Poêle chinoise, alier
Wok, hierro

art.	ø cm.	h.
49605-46	45,5	14,0
49605-61	61,0	18,5
49605-71	71,0	22,0



Coperchio per wok, alluminio
Wok lid, aluminum
Wok-Deckel, Aluminium
Couvercle pour poêle chinoise, alu
Tapa para wok, aluminio

art.	ø cm.
49602-25	25
49602-30	29
49602-33	31
49602-35	34

Un elemento fondamentale nella cucina cinese, il coperchio del wok è usato per i piatti cotti al vapore, stufati o affumicati. - A vital piece of equipment in the Chinese kitchen, the wok lid is used when dishes are being steamed, simmered or smoked.



Base per wok, inox
Wok stand, stainless steel
Fuss für Wokpfanne, Edelstahl Rostfrei
Base pour wok, inox
Base para Wok, inox

art.	ø cm.
11953-22	22



Padella balti/karahi
Balti pan
Balti-Pfanne
Poêle balti
Sartén balti

art.	ø cm.
49657-15	15,2
49657-20	20,3
49657-25	25,4



Balti e karahi sono lo stesso stile di cucina, originario del Kashmir, dove le pietanze al curry sono realizzate in una padella in ghisa con fondo arrotondato e due maniglie, simile ad un wok cinese. Spezie tipiche utilizzate sono: anice, cardamomo, corteccia di cassia, chiodi di garofano, coriandolo, cumino, finocchio, zenzero e una miscela di spezie chiamata garam masala. Spesso questi pasti vengono consumati senza riso o posate, utilizzando un pane indiano detto naan. - Balti and karahi are the same style of cooking, originating in Kashmir, where the curries are made in a cast-iron pan with a rounded bottom and two handles, rather like a Chinese wok. Typical spices used in balti curries are aniseed, cardamom, cassia bark, cloves, coriander, cumin, fennel, ginger and the spice blend called garam masala. Balti curries are often eaten without rice or cutlery, using large, flat breads such as naan.



Padella balti base legno
Balti pan with wood base
Balti-Pfanne mit Holz-Basis
Poêle balti avec base en bois
Sartén balti base de madera

art.	ø cm.
49656-02	15,2



Padella per friggere, ferro
Steel fry pan
Frittier-Eisenpfanne
Tuile à frire, acier
Sartén freidora, hierro

art.	Ø cm.	h.	lt.
41707-32	32	9,8	6,0
41707-36	36	11,0	8,8
41707-40	40	13,4	12,2
41707-45	45	15,0	17,3
41707-50	50	17,6	23,5



Cestello per friggere, stagnato
Wire basket, tinned
Frittier-Rost, verzinkt
Grille à frire, étamée
Cesta escurrefrito, estañada

art.	Ø cm.	h.
41708-32	32	11,0
41708-36	36	11,5
41708-40	40	12,4
41708-45	45	15,5
41708-50	50	16,5



Padella omelette, antiaderente
Japanese omelettes pan, non-stick
Japanische Omelette Pfanne mit Antihafbeschichtung
Poêle à omelettes, revêtement anti-adhésif
Sartén antiadherente para tortillas japonesas

art.	dim. cm.	h.
49655-38	22x21	3,5



Padella tawa, ferro
Steel tawa pan
Tawa-Eisenpfanne
Poêle tawa, acier
Sartén tawa, hierro

art.	Ø cm.
49614-28	28

Queste padelle piane sono utilizzate nella cucina indiana, per focacce e tutto ciò che ha bisogno di cottura rapida ad alta temperatura. L'anatra di Bombay a volte viene cucinata su tawa. CURIOSITA': L'anatra Bombay o bummalo, nonostante il nome, non è una papera, ma bensì un pesce. E' originario delle acque tra Mumbai (ex Bombay) e Kutch nel Mar Arabico. - *These flat pans are used in Indian cooking, for chapattis and anything that needs quick cooking at high temperatures. Bombay duck is sometimes cooked on a tawa. The Bombay duck or bummalo is, despite its name, not a duck but a lizardfish. It is native to the waters between Mumbai (formerly Bombay) and Kutch in the Arabian Sea.*



Chapattis



Cuocivapore, inox
Steamer, stainless steel
Dampf-Kocher, Edelstahl Rostfrei
Cuisneur à vapeur, inox
Cuscusera, inox

art.	Ø cm.	h.	
49606-51	51	14	base
49606-00	51	14	inserto - body
49606-01	51	20	coperchio - cover



Vengono utilizzati con la fonduta cinese per contenere gli alimenti durante la cottura nel brodo. - *These mesh scoops are used with the Chinese hot pot, to hold food while it is cooking in the pot.*



Porzionatore
Scoop
Portionierer
Cuiller
Porcionador

art.	
49616S01	inox - s/s
49616B01	ottone - brass



Pentola cinese, alluminio
Chinese hot pot, aluminium
Chinese- Suppentopf, Alu
Marmite chinoise, alu
Olla chino, aluminio

art.	ø. cm.	h.
49616-22	22	17
49616-24	24	20
49616-26	26	22



Casseruola terracotta
Clay pot
Tontopf
Pot d'argile
Olla de barro

art.	ø. cm.	h.	kg.
49632-24	20	10	1,5
49632-32	28	16	2,7



Casseruola terracotta
Clay pot
Tontopf
Pot d'argile
Olla de barro

art.	ø. cm.	h.	kg.
49633-22	16,5	10	0,75
49633-24	19,0	12	1,35

Tecnica di cottura degli alimenti in una casseruola di terracotta che è stata prima immersa in acqua in modo da liberare il vapore durante il processo di cottura. Evitare sbalzi di temperatura, posizionare la casseruola con il suo contenuto in forno non preriscaldato. Tradizionalmente la casseruola viene utilizzata per servire direttamente dal forno alla tavola. Non mettere in lavastoviglie. - Clay pot cooking is a technique of cooking food in an unglazed clay pot which has been soaked in water so as to release steam during the cooking process. Avoid rapid temperature changes, place the pot with its content in a cold oven and set the temperature. Traditionally the clay pot is served right from oven onto the dinner table. Do not put in dishwasher.



Piatto ghisa con vassoio legno
Sizzler platter, cast iron
Gusseisenplatte
Plat en fonte
Fuente hierro fundido

art.	dim. cm.	dim. cm. ext.
49615-01	22x15	33,5x22



Piatto con supporto legno
Oval plate with wooden platter
Ovalplatte mit Holzbrett
Plat oval avec planche bois
Fuente ovale con tabla madera

art.	dim. cm.
44223S19	12,5x19



Padella grill, alluminio antiaderente
Grill pan, aluminum, non-stick coated
Grill-Pfanne, Aluminium, nichthaftend
Poêle à griller, alu, anti-adhérente
Sartén grill, aluminio, antiadherente

art.	dim. cm.	h.
16971-36	36,5x22,5	3,5
16971-47	47x29	4,5



Mortaio e pestello
Mortar and pestle
Mörser und Stößel
Mortier et pilon
Mortero y pistilo

art.	ø. cm.	h.	kg.
49618-12	9	10,5	2,6
49618-15	11	12,0	4,1
49618-18	14	13,5	5,8



Oliera, inox
Soy/oil sauce pot, stainless steel
Oelständer, Edelstahl Rostfrei
Huilière, inox
Alcuza, inox

art.	ø. cm.	h.
49631-08	7	11,5
49631-11	11	17,0



Colapasta
Noodle strainer
Nudeln-Sieb
Passoire
Colador

art.	ø. cm.	h.	l.
49601-14	14	13	22

Inox e legno naturale.
Stainless steel and natural wood.

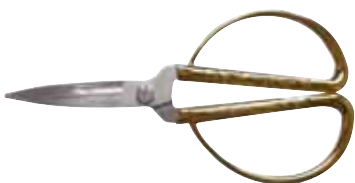

Forbice carni
Meat scissors
Fleischschere
Ciseaux à viande
Tijeras para carne

art.	l. cm.
49636-00	17



Pinza per anatra
Duck fur pincer
Ente Fell Zange
Pince à canard
Pinza pato

art.	l. cm.
49637-00	15



Squamapesce
Fish scaler
Fischentschupper
Ecailleur à poisson
Escamador

art.	l. cm.
49638-00	22

CUCINA ETNICA ETHNIC CUISINE



Schiumarola fritto, rete grossa
Fry basket, coarse mesh
Frittierkorb
Panier de friture
Cesta para freir

art.	Ø cm.
49607-15	15,0
49607-20	20,0
49607-25	25,5
49607-30	30,5



Schiumarola fritto, rete fine
Fry basket, fine mesh
Frittierkorb
Panier de friture
Cesta para freir

art.	Ø cm.
49608-15	15,0
49608-20	20,0
49608-25	25,5
49608-30	30,5
49608-35	35,5

Manico bamboo, rete inox. - Bamboo handle, stainless steel mesh.



Schiumarola
Skimmer
Schaumlöffel
Ecuoire
Espumadera

art.	Ø cm.	L.
49617-23	24	45
49617-25	26	46
49617-30	30	50

Inox. Usati per rimuovere cibi fritti o lessati dai wok. - Stainless steel. Used to remove deep fried or boiled foods from the wok.



Mestolo
Ladle
Schöpföffel
Louche
Cacillo

art.	Ø cm.
49609-12	11,8
49609-14	13,8



Paletta
Spatula
Teigschäber
Spatule
Espátula

art.	dim. cm.
49610-11	11x10,2
49610-14	13,3x12

Inox e legno naturale. - Stainless steel and natural wood.



Bastoncini per cucinare, bamboo
Bamboo cooking chopsticks
Bambus Kochstäbchen
Baguettes de cuisine en bambou
Palillos para cocinar de bambú

art.	l. cm.	paia/pairs
49629-45	45	1

Monouso. Oltre a quelli classici per mangiare ne esistono di più lunghi, sempre in bambù, necessari per mescolare. - Disposable. Large chopsticks used to manipulate food while it is being cooked.



Grattugia per wasabi
Wasabi grater
Wasabi-Raffel
Rape à wasabi
Rallador para wasabi

art.	dim. cm.
42555-11	11x7,5



Pennello per wok, bamboo
Bamboo wok brush
Wok-Pinsel, Bambus
Pinceaux à wok, bambou
Pincel para wok, bambú

art.	l. cm.
49634-00	25,5



Spazzola per wok
Wooden handled wok brush
Wok-Bürste, Holzgriff
Brosse à wok, manche bois
Cepillo para wok, mango madera

art.	l. cm.
49635-00	27,5

L'originale spazzola cinese è fatta di strisce di bambù tenute insieme ad un'estremità ed usata per pulire il Wok sotto l'acqua corrente. - The original Chinese wok cleaning brush is made of strips of Bamboo held together at the top and used to clean out the wok under running water.

COLTELLI SUSHI GIAPPONESI P

JAPANESE SUSHI KNIVES



Una scelta eccellente per la preparazione di sushi e verdure. Lame in acciaio inox, molibdeno e vanadio, per un'ottimale tenuta del filo, affilatura a rasoio, manici in legno antiscivolo. Secondo la tradizione giapponese l'affilatura è unilaterale ed il filo è molto più sottile rispetto a quello della normale affilatura dei coltelli occidentali. Questo rende i tagli più nitidi ed evita di creare traumi alla trama delicata di carne e pesce crudo. Non utilizzare per il taglio di solidi incluse grosse lisce di pesce. Data la particolarità dell'affilatura e dell'acciaio impiegato si consiglia vivamente di lavare a mano ed asciugare immediatamente con cura le lame.

Excellent choice when preparing sushi and vegetables. Molybdenum/Vanadium s/s blades for excellent edge retention, razor sharp edges, slip resistant wooden handles. The blades are sharpened with the traditional Japanese single bevel to improve sharpness. The large beveled one-sided edge is much thinner than a two-sided edge. This thinner, sharper edge makes for cleaner cuts through the soft flesh of fish, in particular. Using these knives will avoid bruising the delicate texture of raw fish and destroying the freshness of the fish. The thinner edge is more fragile than the edge on western knives. Do not use for cutting anything solid including larger fish bones. Due to the special blade sharpening and s/s used we highly recommend to only hand wash and dry the blades thoroughly immediately.

DEBA

art.	l. cm.
18280-22	22,5
18280-16	16,5
18280-10	10,5

Affilato e dalla lama pesante usato per disossare e tagliare il pesce utilizzato nel sushi. È simile ad un coltello da chef. - *The Deba is a powerful knife used for filleting fish and butchering meat without bones. Its weight and thickness can chop through fish bones and the sharp edge can fillet even the smallest of fish.*



OROSHI

art.	l. cm.
18281-24	24

Per sfilettare il tonno e altri pesci di grandi dimensioni. An Orosi Knife is a Japanese all-purpose cooking knife, but used particularly for fish.



USUBA

art.	l. cm.
18282-22	22,5
18282-18	18,0
18282-19*	18,0

*doppia affilatura

*double bevel

Coltello estremamente affilato con una punta quadrata. Questo coltello è usato per tagliare verdure e quando è tenuto ben affilato può tagliarle in fette sottili come un foglio di carta. - *The Usuba is the ultimate vegetable knife. Sharp and thin, it is used by chefs in Japan for katsuramuki, a traditional style of peeling vegetables into thin sheets.*



TAKO SASHIMI

art.	l. cm.
18283-33	33
18283-27	27

Il coltello Tako Sashimi assomiglia di più ad un coltello occidentale ed è utilizzato per affettare tagli spessi di carne per sushi. Ha la lama senza punta, per evitare di rovinare i tentacoli del polpo. - *The Tako Sashimi is a variation of the Yanagi and is used to slice straight-cut sashimi. The blunt tip and balanced weight works well on difficult ingredients like octopus, from which it gets its name. Originated in Kanto (Tokyo) region.*



YANAGI SASHIMI

art.	l. cm.
18284-21	21
18284-27	27
18284-30	30
18284-33	33

Viene utilizzato per tagliare sottili fette di verdure, carne o pesce, nonché per tagliare in generale a dadi o a fette. Grazie alla sua lama sottile ed affilata è utilizzato anche per creare guarnizioni o tagliare i rotoli di sushi. *The Yanagi Sashimi is a slicing knife used to cut boneless fish fillets into sashimi and topping for sushi. The graceful, thin blade cuts beautiful slices in one long, drawing stroke. Originated in Kansai (Osaka) region.*



APPARECCHI ELETTRICI *ELECTRIC APPLIANCES*

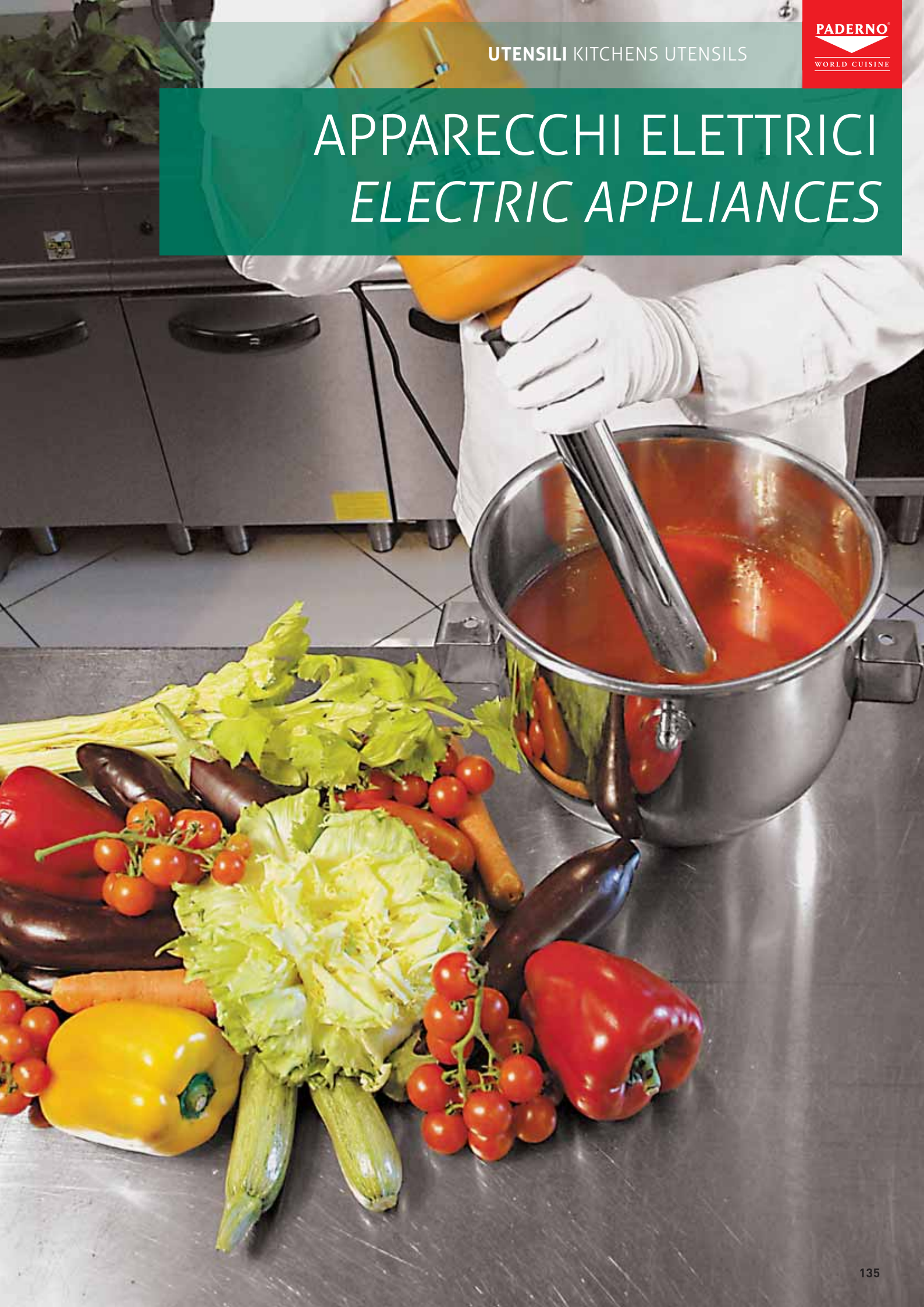



Grill a contatto, SAVOYE
Contact grill
Kontaktgrill
Grill à contact
Grill de contacto

art.	dim. cm.	h.	V	KW	kg.
49850-22	33x38,5	22	230	2	18

Superficie di cottura 260x240 mm. Piastre in ghisa. Piastra superiore autobilanciata regolabile. Termostato regolabile fino a 350°C, vassoio raccogli liquidi. - *Cooking surface mm 260x240. Fitted with upper and lower cast iron plates. The upper plate is self-balancing and the pressure spring is adjustable. Thermostat setting up to 350°C, juice tray.*



Grill a contatto, PANINI
Contact grill
Kontaktgrill
Grill à contact
Grill de contacto

art.	dim. cm.	h.	V	KW	kg.
49850-21	43x38,5	22	230	3	22,5

Superficie di cottura 360x240 mm. Piastre in ghisa. Piastra superiore autobilanciata regolabile. Termostato regolabile fino a 350°C, vassoio raccogli liquidi. - *Cooking surface mm 360x240. Fitted with upper and lower cast iron plates. The upper plate is self-balancing and the pressure spring is adjustable. Thermostat setting up to 350°C, juice tray.*



Grill a contatto doppia piastra, MAJESTIC
Contact grill double plate
Kontaktgrill, 2 Platten
Grill à contact, 2 plaques
Grill de contacto doble

art.	dim. cm.	h.	V	KW	kg.
49850-23	60x38,5	22	380	4	33,5
Oppure/Or		230	2x2		

Doppia superficie di cottura: 2 x (360x240 mm). Piastre in ghisa. Piastra superiore autobilanciata regolabile. Termostato regolabile fino a 350°C, vassoio raccogli liquidi. - *Double cooking surface: 2 x (mm 360x240). Fitted with upper and lower cast iron plates. The upper plate is self-balancing and the pressure spring is adjustable. Thermostat setting up to 350°C, juice tray.*



Busta toast/hamburger, 2 pz, icflon
Bag for toaster/grill, 2 pcs, icflon
Toast-/Hamburger-Tasche, icflon
Sac à toast/hamburger, icflon
Bolsa para tostadas/hamburger, icflon

art.	dim. cm.	
41682-17	17x20	TOAST
41682-20	20x20	HAMBURGER

Ideali per intolleranze alimentari. Riutilizzabili almeno 50 volte. Lavabili in lavastoviglie. - *Ideal for food intolerances. Reusable over 50 times. Dishwasher proof.*



Grill a contatto, PANINI XL
Contact grill
Kontaktgrill
Grill à contact
Grill de contacto

art.	dim. cm.	h.	V	KW	kg.
49850-19	41x62	34	230	3,6	32

Funzione contact-grill, con una superficie di cottura extra large (360x360 mm) e funzione bistecchiera. Costruzione robusta studiata per un utilizzo intensivo (dispositivo di sicurezza). 4 impostazioni cottura, termostato 0-300°C. - *Contact-grill function, with an extra large cooking surface (360x360 mm) and griddle plate function. Strong construction especially studied for heavy duty use (safety device). 4 settings cooking selector, precise bulb thermostat 0-300°C.*



Grill a contatto vetroceramica, PANINI VC
Glas ceramic contact grill
Kontaktgrill, Glaskeramik-Platte
Grill à contact vitrocéramique
Grill de contacto vitrocéramica

art.	dim. cm.	h.	V	KW	kg.
49850-18	39x62	24	230	1,5	13

Senza preriscaldamento, facile da pulire. Termostato regolabile 0-300°C, interruttore ON/OFF, spia d'accensione, vassoio estraibile. Superficie di cottura 330x280 mm. - *No preheating, easy cleaning. Thermostat 0-300°C, ON/OFF switch, pilot light, removable drip tray. Cooking surface mm 330x280.*



Piastra in vetroceramica, PS 400 VC
Glass ceramic griddle plate
Glaskermik-Grillplatte
Plaque à snacker vitrocéramique
Plancha hasadora vitrocerámica

art.	dim. cm.	h.	V	KW	kg.
49850-60	39x42	15	230	1,5	7

Senza preriscaldamento, facile da pulire. Termostato regolabile 0-300°C, interruttore ON/OFF, spie di controllo, cassetto raccogli-liquidi removibile. - *No preheating, easy cleaning. Thermostat 0-300°C, ON/OFF switch, pilot light, removable drip tray.*



Piastra in acciaio smaltato, PSR 600 EE
Griddle plate in enamelled steel
Grillplatte aus emailliertem Stahl
Plaque à snacker acier émaillé
Plancha de acero esmaltado

art.	dim. cm.	h.	V	KW	kg.
49850-59	60x47,5	23	220	2x3	29

Piastra in acciaio smaltato 10 mm. Vassoio di raccolta liquidi e grassi di cottura. Costruzione in acciaio inox con isolamento rinforzato. Collettore, termostato 0-300°C, spia d'accensione e termostatica. Superficie di cottura 600x400 mm. - *Steel enamelled griddle plate 10 mm. Drip tray for juice and grease draining. Stainless steel construction and reinforced insulation. Commutator, thermostat 0-300°C, pilot light, thermostatic pilot light. Cooking surface mm 600x400.*



Scalda würstel, CS 3 E
Hot dog heater
Würstchenwärmer
Chauffe-saucisses
Calentador de salchichas

art.	dim. cm.	h.	V	KW	kg.
49850-61	44x30	40	230	0,65	9

Con 3 tostapane in alluminio alimentare, contenitore teflon, controllo della potenza, spie di controllo. - *3 heating elements alimentary aluminum, teflon container, power control system, pilot lights.*



Griglia kebab/gyros, GR 40/60 E
Kebab/Gyros grill
Elektro-Dönergrill
Gril à kebab/gyros
Asador de kebab/gyros

art.	dim. cm.	h.	V	KW	kg.	kg. carne/meat
49850-13	58x66	69,5	230	3,6	27	15
49850-14	58x66	87,0	380	5,8	31	25

È possibile spostare il pilastro e la sorgente calore e regolare ciascuna zona per ottimizzare la cottura in funzione dell'altezza e diametro del pezzo di carne. Piastra inferiore completamente ermetica. Dotato di capiente collettore di succo, vasca di raccolta estraibile. Funzioni on/off, spia d'accensione. - *You can move the pilaster and heat source and regulate each zone to adjust the cooking to the height and diameter of the piece of meat. Bottom plate fully hermetic. Fitted with a large stamped juice collector with a removable drip tray. Features on/off switch, pilot lights.*



Crepiera tonda, ad alto rendimento, CFE 400
Crepe machine, high-capacity
Crêpegerät
Crêpière à haut rendement
Crepera

art.	ø cm.	h.	V	KW	kg.
49850-33	40	20	230	3,6	18

Piastra in ghisa verniciata ø 40 cm. Potenza maggiorata per uso all'aperto. Elemento riscaldante a spirale, termostato regolabile da 0 a 300°C, spia di controllo. - *Enamelled cast iron plate ø 40 cm. High power output for outdoor use. Spiral heating element, thermostat 0 to 300°C, pilot light.*



Crepiera singola, CSE 400
Single crepe machine
Crêpegerät
Crêpière simple
Crepera

art.	dim. cm.	h.	V	KW	kg.
49850-11	45x50	24	230	3,6	23

Piastra in ghisa verniciata ø 40 cm. Elemento riscaldante a spirale, spia di controllo. - *Enamelled cast iron plate ø 40 cm. Spiral heating element, pilot light.*





Crepiera doppia, CDE 400
Double crepe machine
Crêpegerät, 2 Platten
Crêpière double
Crepera 2 placas

art.	dim. cm.	h.	V	KW	kg.
49850-12	86x50	24	380	7,2	44

Oppure/Or 230 2x3,6

Piastre in ghisa verniciata ø 40 cm. Elemento riscaldante a spirale, spia di controllo. - Enamelled cast iron plates ø 40 cm. Spiral heating element, pilot light.

Forno multifunzione, FC 280
Multifunction oven
Multifunktionsofen
Four multifunctions
Horno multifunción

art.	dim. cm.	h.	V	KW	kg.	int. dim. cm.
49850-73	46x55	35,5	230	1,5	20	32x32,5x26,5

Utilizzato per cuocere o riscaldare. Cottura omogenea grazie a fori di ventilazione che garantiscono una perfetta circolazione dell'aria. Isolamento rinforzato. Caratteristiche: termostato (0-230°C), ventilatore, 120 min. timer e luci spia. Fornito con 2 griglie di cottura, 1 vassoio pasticceria. - Used for cooking or reheating. Homogeneous cooking thanks to ventilation holes ensuring a perfect circulation of the air. Reinforced insulation. Features: thermostat (0-230°C), fan, a 120 min. timer and pilot lights. Supplied with 2 cooking grids, 1 pastry tray.



Forno multifunzione, FC 380 TQ
Multifunction oven
Multifunktionsofen
Four multifunctions
Horno multifunción

art.	dim. cm.	h.	V	KW	kg.	int. dim. cm.
49850-75	55x55	35,5	230	2,4	22	41,5x35x26,5

Coniuga le funzioni convezione, turbo quarzo, grill, forno ventilato e scongelamento. Isolamento rinforzato. Caratteristiche: termostato (0-230°C), ventilatore, 120 min. timer e luci spia. Fornito con 3 griglie di cottura, 1 vassoio pasticceria. - This oven combines convection, Turbo Quartz, grill function, ventilated oven and defrosting. Reinforced insulation. Features: thermostat (0-230°C), fan, a 120 min. timer and pilot lights. Supplied with 3 cooking grids, 1 pastry tray.

Forno multifunzione 4 GN 2/3, FC 60 TQ
Multifunction oven
Multifunktionsofen
Four multifunctions
Horno multifunción

art.	dim. cm.	h.	V	KW	kg.	int. dim. cm.
49850-76	59,5x61	59	230	3	38	47x37x35

Coniuga la convezione, forno ventilato, turbo quarzo e grill quarzo. Caratteristiche: termostato 0-300°C, 120 min. timer sonoro con posizione di blocco per uso in continuo, luce interna, luci spia, piedini regolabili. Fornito con 4 griglie 450x340 mm. - Combines convection, ventilated oven, turbo quartz and quartz grill. Features: thermostat 0-300°C, 120 min. bell timer with lock position for continuous setting, inside light, pilots lights, adjustable feet. Delivered with 4 grids 450x340 mm.





Forno verticale "salvaspazio", FCV 280
Senkrechter Ofen
Vertical-Backofen
Four vertical
Horno vertical

art.	dim. cm.	h.	V	KW	kg.	int. dim. cm.
49850-74	37x53	49,5	230	1,5	20	26x33x32

Riscaldamento: 230°C in 12'. Cottura omogenea grazie a fori di ventilazione che garantiscono una perfetta circolazione dell'aria. Porta con doppio vetro. Isolamento rinforzato. Caratteristiche: commutatore-termostato (0-230°C), ventilatore, luci spia. Guide inox 5 livelli removibili, 4 griglie (255 x 310 mm), 1 vassoio. - *Temperature rise: 230°C in 12'. Homogeneous cooking thanks to ventilation holes ensuring a perfect circulation of the air. Double-glazed vertical door. Reinforced insulation. Features: commutator-thermostat (0-230°C), fan, pilot lights, removable stainless steel grid holders with 5 levels, 4 perforated plates (255x310 mm), 1 tray.*



Forno a nastro, CT3000
Conveyor oven
Tunnelofen
Four conveyeur
Horno a túnel

art.	dim. cm.	h.	V	KW	kg.	int. dim. cm.
49850-72	47x72	38,5	230	3	22	30x37

Ideale per uso intensivo. Cuoce non-stop senza preriscaldamento. Caratteristiche: 8 tubi al quarzo (1.550 W sopra, 1.450 W sotto), tetto con cavità e griglia di protezione (brevettato), selettore tubi quarzo, controllo velocità, nastro trasportatore con maglia inox, vassoi anteriore e posteriore 15 cm., spia d'accensione, motori ventilati, piedini regolabili. *Ideal for intensive use. Cooks non-stop with no preheating. Features: 8 quartz tubes (1.550 W on top, 1.450 W on bottom), roof with cavity and protection grid (patented), quartz tubes selector (off, full and half power on top), speed control, conveyor belt with stainless steel mesh, front and back trays of 15 cm, pilot lights, ventilated motors, adjustable feet.*



Salamandra, SEM 600 PDS
Salamander with Plate Detection System
Salamanders mit PDS
Salamandre avec détection de plat
Salamandra con PDS



art.	dim. cm.	h.	V	KW	kg.	int. dim. cm.
49850-71	60x64	59	230	3	56	49,5x37,5

La salamandra si accende quando il piatto entra in contatto con la barra inox. Facile da pulire, removibile. Sistema di controllo potenza. Commutatore per selezionare le 3 aree di riscaldamento. - *The salamander starts when the plate pushes the contact s/s bar. Easy cleaning: bar is completely removable. Power control system. Commutator to select the heating area (3).*



Tostapane, BAR 1000
Toaster
Toaster
Toaster
Tostador de pan

art.	dim. cm.	h.	V	KW	kg.
49850-65	45x28,5	30,5	230	2	10

Resa: 150 pezzi/h. Timer 15' con blocco per utilizzo continuato, spia di controllo e maniglia removibile. Fornito con griglia di protezione per tubi al quarzo. - *Optimal output: 150 pieces/h, quartz tubes selector, 15' timer with a lock position for non-stop use, pilot light and removable handle. Delivered with protection grid for quartz tubes.*



Tostapane, BAR 2000
Toaster
Toaster
Toaster
Tostador de pan

art.	dim. cm.	h.	V	KW	kg.
49850-66	45x28,5	42	230	3	12

Resa: 300 pezzi/h. Timer 15' con blocco per utilizzo continuato, spia di controllo e maniglia removibile. Fornito con griglia di protezione per tubi al quarzo. - *Optimal output: 300 pieces/h, quartz tubes selector, 15' timer with a lock position for non-stop use, pilot light and removable handle. Delivered with protection grid for quartz tubes.*



Tostapane a nastro doppia uscita, CT 540 B
Conveyor toaster
Tunnel-Toaster
Toaster conveyeur
Tostador a túnel

art.	dim. cm.	h.	V	KW	kg.
49850-20	50x68	34,5	230	2,65	20

Resa ottimizzata: 300-540 pezzi/h, senza preriscaldamento. Velocità e tostatura regolabili. 8 tubi al quarzo (1.200W sup., 1.450W inf.). - *Optimal output: 300-540 pieces/h, with no preheating. Adjustable speed and toasting. 8 quartz tubes (1.200W on top, 1.450W on bottom).*



N

Espositore caldo ventilato, WD 780 SI
Ventilated warming display
Konvektion-Warme Theke
Présentoir chaud à convection
Expositor caliente con convección

art.	dim. cm.	h.	KW	kg.
49850-69	78x49	48	1,2	30

Sistema di illuminazione a LED. 2 aperture verticali (180°) sul lato posteriore. Capacità: 2 vassoi GN 1/1 o 2 teglie pasticceria 40x60cm o 2 vassoi US full size. Caratteristiche: termostato elettronico (20-90°C), interruttore on/off, interruttore per la ventilazione, contenitore d'acqua, 2 griglie (67x43,3cm), 4 livelli. Fornito senza vassoi. - LED lighting system. 2 vertical openings (180°) on back side. Capacity: 2 GN 1/1 trays or 2 pastry trays 40x60cm or 2 US full size trays. Features: electronic thermostat (20-90°C), on/off switch, switch for ventilation, water container, 2 grids (67x43,3cm) and 4 levels. Delivered without any tray.



N

Espositore caldo ventilato, WD 780 DI
Ventilated warming display
Konvektion-Warme Theke
Présentoir chaud à convection
Expositor caliente con convección

art.	dim. cm.	h.	KW	kg.
49850-70	78x49	64	1,8	35

Sistema di illuminazione a LED. 2 aperture verticali (180°) sul lato posteriore. Capacità: 3 vassoi GN 1/1 o 3 teglie pasticceria 40x60cm o 3 vassoi US full size. Caratteristiche: termostato elettronico (20-90°C), interruttore on/off, interruttore per la ventilazione, contenitore d'acqua, 3 griglie (67x43,3cm), 5 livelli. Fornito senza vassoi. - LED lighting system. 2 vertical openings (180°) on back side. Capacity: 3 GN 1/1 trays or 3 pastry trays 40x60cm or 3 US full size trays. Features: electronic thermostat (20-90°C), on/off switch, switch for ventilation, water container, 3 grids (67x43,3cm) and 5 levels. Delivered without any tray.



Bollitore uova, CO 60
Eggs boiler
Eierkocher
Cuiseur à oeuf
Caldera para huevos

art.	dim. cm.	h.	V	KW	kg.
49850-36	21,5x43	25,5	230	1,2	4,5

Bollitore GN 1/3. Capacità 10 uova. Dotato di termostato, limitatore di temperatura, bottone ON/OFF. Fornito con 6 cestelli numerati. - Boiler GN 1/3. Capacity 10 eggs. Delivered with 6 numbered baskets. Equipped with thermostat, temperature limitator, ON/OFF press button.



Scaldapiatti, DW106 / 110
Dish-warmer
Rechaud
Chauffe plats
Calentador de platos

art.	dim. cm.	h.	V	KW	kg.
49850-06	40x21,5	33,5	220	0,65	14
49850-10	40x21,5	47,5	220	1,30	25

Preriscaldamento 15 minuti. Le placche conservano i piatti da portata a temperatura per 45 minuti. Termostato con interruttore bi-polare. Fifteen min. preheating. The panels keep dishes warm for 45 min. Regulating thermostat, double-pole pilot light.



N

Scaldasalse, WI-1
Sauce & chocolate warmer
Sauce und Schokowärmer
Chauffe-chocolat et sauce
Calentador para salsa y chocolate

art.	dim. cm.	h.	V	KW	lt.	kg.
49850-01	22,5x17,5	22	230	0,17	1	2

Riscalda e scioglie ogni tipo di guarnizione, nocciola, cioccolato, miele, ecc ...Termostato commutatore. Timer elettronico. Spia d'accensione. Fornito con 2 flaconi dosatori. - Warms and melts every kind of hazelnut topping, chocolate, honey... etc. Commutator thermostat. Electronic timer. Pilot light. Delivered with 2 squeeze bottles.



N

Fornello gas, GAR 7 - GAR 12
Gas stove burner
Gaskochfeld, Brenner
Réchaud gaz brûleur
Plano de cocción a gas, quemador

art.	dim. cm.	h.	KW	kg.
49850-15	37x51	19,5	7	13
49850-16	69x51	19,5	12 (7+5)	22

In acciaio inox per cottura a gas (NG & GPL). Sistema di accensione piezo, controllo indipendente delle zone di cottura con termocoppia di sicurezza. Griglia in ghisa, testa del bruciatore e piastra inox removibili. Forniti con supporto per casseruole piccole. - In stainless steel for both NG & LPG gas cooking. Piezo lighting system, independent control of cooking areas with safety thermocouple. Cast iron grid, removable cover of the burner and stainless steel plate. Supplied with stainless steel holder for small pans.



Friggitrice, FD 50 / FD 50 D
Fryer
Fritteuse
Friteuse
Freidora

art.	dim. cm.	h.	V	KW	kg.	kg/h	int. dim. cm.
49850-37	21,5x42,5	32	230	3,2	5	10	14x26x10
49850-39	39x42,5	32	2x230	2x3,2	10	20	2x14x26x10

Friggitrice, FD 80 / FD 80 D
Fryer
Fritteuse
Friteuse
Freidora

art.	dim. cm.	h.	V	KW	kg.	kg/h	int. dim. cm.
49850-38	28x42,5	32	230	3,6	7	15	22x26x10
49850-48	54x42,5	32	2x230	2x3,6	12	30	2x22x26x10

Filtraggio automatico dell'olio per decantazione. Dotate di termostato di regolazione a bulbo ed un termostato inox a doppia sicurezza in caso di surriscaldamento o olio insufficiente e micro-interruttore a contatto. I cestelli hanno manici termoresistenti. Facili da pulire: 5 pezzi completamente removibili, serbatoio dell'olio lavabile in lavastoviglie. Versione con rubinetto: il serbatoio unipiece, inclinato, è stato studiato per permettere all'olio di confluire direttamente nel rubinetto senza dover manipolare la friggitrice.

Automatic oil filtering by decanting. Equipped with s/s bulb regulation thermostat, double safety thermostat which cuts out in case of overheating or lack of oil and microswitch. Baskets are fitted with thermoresistant handles. Easy cleaning: 5 completely removable parts, oil container dishwashersafe. Model with draining device: oil tank one piece made, leaning made for direct flow of the oil in the front tap without fryer further handling.



Friggitrice, FD 80 R
Fryer
Fritteuse
Friteuse
Freidora

art.	dim. cm.	h.	V	KW	kg.	kg/h	int. dim. cm.
49850-41	26,5x45	36	230	3,6	8	15	22x26x10

Friggitrice, FD 80 DR
Fryer
Fritteuse
Friteuse
Freidora

art.	dim. cm.	h.	V	KW	kg.	kg/h	int. dim. cm.
49850-42	59x45	37	230	2x3,6	15	30	2x22x26x10



Friggitrice su mobile, RFE 16 C
Fryer on cabinet
Fritteuse auf Unterbau
Friteuse sur coffre
Freidora sobre soporte

art.	dim. cm.	h.	V	KW	kg.	kg/h	int. dim. cm.
49850-67	40x66	98	380	4-8-12	34	35	20,5x30,5x14,5

Friggitrice su mobile, RFE 20 C
Fryer on cabinet
Fritteuse auf Unterbau
Friteuse sur coffre
Freidora sobre soporte

art.	dim. cm.	h.	V	KW	kg.	kg/h	int. dim. cm.
49850-68	40x66	98	380	6x2	38	38	2x12,8x32x14,2

Progettate per fast food e ristoranti. RFE 16 C: può essere fornita sia con un pannello grande oppure 2 pannelli. RFE 20 C: dotata di 2 pannelli da 10 Lt ciascuno e con un commutatore per un controllo indipendente delle aree di frittura. Montate su piedini regolabili fino a 150 mm. in acciaio inox (possono essere fissate al pavimento secondo le norme CE - UL / NSF), dotate di relè di potenza, scarico con rubinetto maggiorato e un serbatoio perfettamente isolato con sonda integrata di livello dell'olio "mini-maxi". Due flange in acciaio inox tengono l'elemento riscaldante e i bulbi termostatici. Termostato di sicurezza nella cabina.

Designed for fast food and restaurants. RFE 16 C: can be delivered with either one large basket or two half-size baskets. RFE 20 C: to fry alternatively different products fitted with 2 baskets of 10 L each and with a commutator for an independent control of the frying areas. Mounted on adjustable stainless steel feet till 150 mm (can be fixed on the bottom according to CE - UL / NSF), equipped with a power relay, a large tap draining and a perfect insulated tank with an integrated "mini-maxi" oil level. Two stainless steel flanges hold the heating element and thermostatic bulbs. Reset safety thermostat in the cupboard.



Macchina per cialde, GESIMPLE
Single waffle iron
Waffeleisen mit 1 Platte
Gaufrier simple
Gofrera singular

Macchina per cialde doppia, GESDOUBLE
Double waffle iron
Waffeleisen mit 2 Platten
Gaufrier double
Gofrera doble

art.	dim. cm.	h.	V	KW	kg.
49850-24	30,5x44	23	230	1,6	22
49850-25	30,5x44	23	230	1,6	22
49850-26	30,5x44	23	230	1,6	22
49850-27	30,5x44	23	230	1,6	22

Piastra in ghisa. Vassoio di raccolta estraibile. Interruttore ON/OFF, termostato 0-300°C, luce spia, piedini regolabili. - Cast iron plates. Removable drip-tray. ON/OFF switch, thermostat 0-300°C, pilot lights, adjustable feet.

art.	dim. cm.	h.	V	KW	kg.
49850-28	55x44	23	230	3,2	38
49850-29	55x44	23	230	3,2	38
49850-30	55x44	23	230	3,2	38
49850-31	55x44	23	230	3,2	38



10

-24 / -28



20

-25 / -29



75

-26 / -30



40

-27 / -31



Macchina per cialde, GES23
Single waffle iron
Waffeleisen mit 1 Platte
Gaufrier simple
Gofrera singular



N

art.	dim. cm.	h.	V	KW	kg
49850-03	30,5x44	23	230	1,6	22

Questa macchina per cialde è equipaggiata con timer per cialde di mais (23 cm.). Ottieni 4 cialde dorate e croccanti in un'unica cottura a 270°C in 2,30 minuti. - This waffle iron is fitted out with timer for corn waffles (23cm.). Get 4 golden and crispy waffles in one baking at 270°C in 2,30 min.



Combi mixer/frusta
Mixer/liquidiser combi unit
Kombigerät
Combiné mixeur-fouet
Brazo triturador/batidor, unidad combinada

art.	rpm	max rpm	V	KW	B	C	F	kg.
49907-01	2000-9000	15000	230	0,35	36	43	36	4,95

Idoneo per la lavorazione in contenitori fino a 100 litri di capacità.
Suitable for food-processing in containers up to 100 liters capacity.

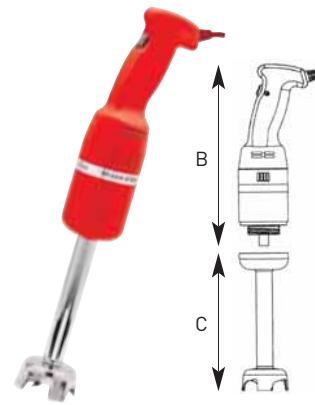

Mixer
Liquidiser
Stabmixer
Mixeur
Brazo triturador

art.	rpm	V	KW	B	C	kg.
49907-06	15.000	230	0,25	28,5	27	1,45

Idoneo per la lavorazione in contenitori fino a 30 litri di capacità.
Suitable for food-processing in containers up to 30 liters capacity.



Supporto murale
Wall rack
Wandständer
Support murale
Soporte mural

art.
49907-AA



Supporto murale per art. 49907-06
Wall rack for item 49907-06
Wandständer für Art.-Nr. 49907-06
Support murale pour réf. 49907-06
Soporte mural para art. 49907-06

art.
49907-AB



Mixer
Liquidiser
Stabmixer
Mixeur
Brazo triturador

art.	rpm	V	KW	kg.	h. cm
49807-00	0-13000	230	0,2	1	39,5

Fornito con 2 coltelli, 2 dischi e 1 misurino graduato. - Equipped with 2 knives, (chopper and star), 2 discs (beater and emulsion) and a graduated pot.



Mixer, per piccole preparazioni
Liquidiser, for small preparations
Stabmixer, für kleine Vorbereitungen
Mini mixer pour petites préparations
Brazo triturador, para pequeñas preparaciones

art.	rpm	V	KW	kg.	h. cm
49808-00	12500-14000	220	0,45	0,82	40
49808-AC	frusta/whisk				
49808-AD	emulsionatore/emulsifier				



49911-24 49916-25 49916-35 49916-45 49916-55

Mixer
Liquidiser
Stabmixer
Mixeur
Braço triturador

art.	rpm	V	KW	kg.	lt.	h. cm
49911-24	2000>12500	230	0,27	1,4		24
49916-25	2300>9600	230	0,27	3,0	15	25
49916-35	2300>9600	230	0,35	3,3	45	35
49916-45	1500>9000	230	0,44	4,9	100	45
49916-55	9000	230	0,75	5,2	200	55



49911-19 49911-30 49911-35 49911-45

Combi mixer/frusta
Mixer/liquidiser combi unit
Kombigerät
Combiné mixeur-fouet
Braço triturador/batidor, unidade combinada

art.	rpm	V	KW	kg.	lt.	h. cm
49911-19	2000>12500 350>1560	230	0,25	1,9		19
49911-30	2300>9600 500>1800	230	0,30	3,1	30	30
49911-35	1500>9000 250>1500	230	0,44	5,9	50	35
49911-45	1500>9000 250>1500	230	0,50	6,1	100	45





Combinato cutter/frullatore ROBOT COOK

Cutter & blender

Gemüseschneid-/ u. Mixermaschine

Cutter/Mixeur

Procesador de alimentos

art.	rpm	KW	kg.	dim. cm.	h.
49949-25	100>3500>4500	1,8	13,5	22,6x33,8	52,2



Velocità variabile da 100 a 3500 giri/min. Velocità Turbo 4500 giri/min. Migliore controllo delle preparazioni grazie al tasto Impulso Alta precisione. Lavora prodotti delicati senza tagliarli con la rotazione inversa dei coltelli: funzione R-Mix. 9 ricette programmabili. Robusto motore industriale asincrono. Dotato di un coltello a fondo vasca ad alta precisione. Potenza di riscaldamento modulabile fino a 140°, regolabile per grado. Un asciuga coperchio anti-vapore. Un foro nel coperchio permette l'aggiunta d'ingredienti nella vasca senza dover interrompere la preparazione. Un sistema innovativo di blocco del coltello permette di svuotare la preparazione in tutta sicurezza. Tutti i pezzi a contatto con gli alimenti si smontano facilmente e sono lavabili in lavastoviglie. Il coperchio è a tenuta stagna e comprende una funzione di sicurezza. Potenza max. di riscaldamento 1200W, potenza motore 1000W, potenza nominale 1800W, 8 Amp. Capacità liquida L. 2,5. - *Speed range from 100 to 3500 rpm. Turbo speed up to 4500 rpm. Better control of the preparations due to the key High precision Pulse. Prepares delicate products without cutting it thanks to the blade reverse rotation: R-Mix function. 9 programmable recipes. Asynchronous industrial motor, very robust. Equipped with high precision knife in the bottom tank. Heating power adjustable up to 140°, per single degree. Anti-steam cover dryer. A hole in the lid allows to add ingredients while working. An innovative lock knife system allows you to empty the preparation safely. All parts in contact with food can be easily dismantled and are dishwasher safe. The watertight lid includes a safety function. Max. heating power 1200W, motor power 1000W, rated power 1800W, 8 Amp. Liquid capacity L. 2,5.*



Centrifuga J80 Ultra

Juice extractor

Fruchtpresse

Centrifugeur-presse agrumes

Centrifugadora/exprimidor jugos

art.	rpm	V	KW	kg.	dim. cm.	h.
49949-20	3000	230	0,7	11	23,5x42	50,5

Per la lavorazione di frutta e verdura. Dotata di vasca per la raccolta dei rifiuti con capacità 6,5 lt, una tramoggia automatica con ø79 mm che permette portate fino a 60kg/orari. Vasca in inox con beccuccio antigoccia. Motore industriale molto silenzioso che mantiene una velocità costante qualunque sia il carico. - *Suitable for fruit and vegetables. Equipped with waste collector 6,5 lt, automatic hopper ø79 mm. Output up to 60kg/h. Stainless steel bowl with non drip spout. Very silent industrial motor, keeps constant speed regardless of the workload.*



Tagliaverdure CL 50 Ultra

Vegetable preparation machine

Gemüseschneidmaschine

Coupe-légumes

Cortador verduras

art.	rpm	V	KW	kg.	dim. cm.	h.
49940-01	375	230	0,55	15	30x36	55,5

Corpo in acciaio inox, dotato di due alimentatori. Produzione max 300 coperti. Può cubettare da 5 a 25 mm. Ideale anche per il taglio della mozzarella. Per utilizzare la macchina vedere pag. 148 per i dischi di taglio. - *Stainless steel base with two sizes feed hoppers. Serving 300 covers max. Dicing from 5 to 25 mm. Suitable also for cutting mozzarella. To use the machine see page 148 for cutting discs.*



Tagliaverdure CL 55
Vegetable preparation machine
Gemüseschneidmaschine
Coupe-légumes
Cortador de verduras

art.	rpm	V	KW	kg.	dim. cm.	h.
49940-03	375/750	400	1,1	27	38x30	84

Motore trifase. Base in acciaio inox. Tramoggia intercambiabile. Produzione max 600 coperti. Può cubettare da 5 a 25 mm. La macchina per le caratteristiche tecniche è ideale anche per il taglio della mozzarella. Per utilizzare la macchina, vedere pag. 148 per i dischi da taglio. - Three phase motor. Stainless steel base. Changeable hopper. Serving 600 covers max. Dicing from 5 to 25 mm. Suitable for the mozzarella cheese cutting too. To use the machine, see page 148 for cutting discs.



Tagliaverdure CL 52
Vegetable preparation machine
Gemüseschneidmaschine
Coupe-légumes
Cortador verduras

art.	rpm	V	KW	kg.	dim. cm.	h.
49940-02	375	400	0,75	21	30x36	64

Motore trifase. Versione da banco base in acciaio inox. Produzione max 500 coperti. Può cubettare da 5 a 25 mm. Modello ideale per lavorare tutte le verdure voluminose come cavoli e melanzane. Per utilizzare la macchina, vedere pag. 148 per i dischi da taglio. - Three phase motor. Table-top model, stainless steel base. Serving 500 covers max. Dicing from 5 to 25 mm. Ideal model to cut all the big vegetables as cabbage and aubergine. To use the machine, see page 148 for cutting discs.



Combinato cutter/tagliaverdure R301 Ultra
Cutter & vegetable slicer
Gemüseschneid/- u. Schälmaschine
Cutter/Coupe-légumes
Cortador verduras

art.	rpm	V	KW	kg.	dim. cm.	h.
49942-01	1500	230	0,65	14	28,5x36	40

Comando ad impulsi. Vasca smontabile inox da 3,7 litri. Produzione max 70 coperti. Dotazione gruppo tagliaverdure in ABS, coltelli lisci. Possibilità di affettare, sfilacciare, listellare, grattugiare, granulare, non può cubettare. Dischi da taglio vedere pag. 148. - Equipped with a pulse control for optimum cutting precision. Stainless steel bowl of 3,7 lt easy to dismantle. Serving 70 covers max. Equipped with a set of ABS slicers, straight knives. Suitable for slicing, scalop cutting, julienne ripple cut slicing and grating, not for dicing. Cutting discs see page 148.



Combinato cutter/tagliaverdure R502
Cutter & vegetable slicer
Gemüseschneid/- u. Schälmaschine
Cutter/Coupe-légumes
Cortador verduras

art.	rpm	V	KW	kg.	dim. cm.	h.
49942-02	750/1500	400	1	30	35,5x30	65,5

Motore trifase. Comando ad impulsi. Vasca smontabile inox da 5,5 litri con coperchio a tenuta liquidi. Produzione max 300 coperti. Dotazione gruppo tagliaverdure in alluminio, coltelli lisci. Può cubettare da 5 a 25 mm. Dischi da taglio vedere pag. 148. - Three phase motor. Equipped with pulse control. Stainless steel bowl of 5,5 lt easy to dismantle. Serving 300 covers max. Vegetable cutting unit in aluminum. Including a straight blade knife. Dicing from 5 to 25 mm. Cutting discs see page 148.



Combinato cutter/tagliaverdure R502 V
Cutter & vegetable slicer
Gemüseschneid/- u. Schälmaschine
Cutter/Coupe-légumes
Cortador verduras

art.	rpm	V	KW	kg.	dim. cm.	h.
49942-03	300/3500	230	1,3	30	35,5x30	65,5

Tagliaverdura variabile da 300 a 1000 giri/min. Vasca smontabile inox da 5,5 litri con coperchio a tenuta liquidi. Produzione max 300 coperti. Dotazione gruppo tagliaverdure in alluminio, coltelli lisci. Può cubettare da 5 a 25 mm. Dischi da taglio vedere pag. 148. - *When using the vegetable preparation function, speed range varies between 300 and 1.000 rpm. Equipped with pulse control. Stainless steel bowl of 5,5 lt easy to dismantle. Serving 300 covers max. Vegetable cutting unit in aluminum. Including a straight blade knife. Dicing from 5 to 25 mm. Cutting discs see page 148.*



Cutter da tavolo R4
Table-top cutter
Gemüseschneidmaschine
Cutter à légumes
Cortador verduras

art.	rpm	V	KW	kg.	dim. cm.	h.
49943-01	1500/3000	400	0,9	17	21x32	43

Motore trifase. Comando ad impulsi. Vasca smontabile inox da 4,5 litri. Corpo in pressofusione. Dotazione coltelli lisci. Disponibili su richiesta coltelli dentati e coltelli dentati fini. - *Three phase motor. Equipped with pulse control. Stainless steel bowl of 4,5 lt. Diecast aluminum body. Including a straight blade knife. Available on demand serrated and slightly serrated blade knives.*



Cutter da tavolo R5 plus
Table-top cutter
Gemüseschneidmaschine
Cutter à légumes
Cortador verduras

art.	rpm	V	KW	kg.	dim. cm.	h.
49943-02	1500/3000	400	1,2	24	28x34	48

Motore trifase. Comando ad impulsi. Vasca smontabile inox da 5,5 litri con coperchio a tenuta di liquidi. Corpo in pressofusione. Dotazione coltelli lisci. Disponibili su richiesta coltelli dentati. - *Three phase motor. Equipped with pulse control. Stainless steel bowl of 5,5 lt. Automatic bowl locking. Diecast aluminum body. Including a straight blade knife. Available on demand serrated blade knife.*



Omogeneizzatore Blixer 4
Emulsifier-mixer
Mixergerät
Emulsionneur-mixer
Omogenizador/emulsificador

art.	rpm	V	KW	kg.	dim. cm.	h.
49944-01	1500/3000	400	1	18	46x22,5	30,5

Motore trifase. Comando ad impulsi. Vasca smontabile inox da 4,5 litri e capacità liquidi massima di 2,5 litri. Dotazione contropala raschiatrice, coltelli a tenuta di liquidi con speciale dentatura. Corpo in pressofusione. *Three phase motor. Equipped with pulse control. Stainless steel bowl of 4,5 lt. Maximum liquid capacity 2,5 lt. Including a scraper arm and special serrated blade knife. Diecast aluminum body.*



Omogeneizzatore Blixer 4 V
Emulsifier-mixer
Mixergerät
Emulsionneur-mixer
Omogenizador/emulsificador

art.	rpm	V	KW	kg.	dim. cm.	h.
49944-02	300/3500	230	1,1	18	46x22,5	30,5

Comando ad impulsi. Vasca smontabile inox da 4,5 litri e capacità liquidi massima di 2,5 litri. Corpo macchina in pressofusione. Dotazione contropala raschiatrice, coltelli a tenuta di liquidi con speciale dentatura. *Equipped with pulse control. Stainless steel bowl of 4,5 lt. Maximum liquid capacity 2,5 lt. Including a scraper arm and a special serrated blade knife. Diecast aluminum body.*



Centrifuga C80
Sieving juicer
Passiermaschine
Centrifugeuse
Centrifugadora

art.	rpm	V	KW	kg.	dim. cm.	h.
49946-01	1500	230	0,65	21	61x36	54

Produzione 50 kg/ora. Versione da banco. Dotazione cestello setaccio con fori ø1 mm, disponibili su richiesta cestello setaccio con fori ø0,5 e ø3 mm. *Hourly output: 50 kg. Table-top model. Including a standard ø1 mm sieve, available on demand sieves ø0,5 and ø3 mm.*

	49941 R 301 Ultra	49940 R 502 / R 502 V.V. CL 50 Ultra CL 52 / CL 55
	Dischi Discs	
	0,8 mm	AA
	1 mm	AB
	2 mm	AC
	3 mm	AD
	4 mm	AE
	5 mm	AF
	6 mm	AG
	8 mm	AH
	10 mm	AI
	2 mm	AL
	3 mm	AM
	5 mm	AN
	1,5 mm	AO
	2 mm	AP
	3 mm	AQ
	4 mm	AR
	5 mm	AS
	6 mm	AM
	7 mm	AT
	9 mm Rösti	AN
	Parmesan	AO
	Raifort 0,7 mm	AP
Raifort 1,0 mm	AQ	
Raifort 1,3 mm	AR	
	2x2 mm	AY
	2x4 mm	BA
	2x8 mm	BC
	3x3 mm	BD
	4x4 mm	BE
	6x6 mm	BF
	8x8 mm	BG
	5x5x5 mm	■ BM
	8x8x8 mm	■ BN
	10x10x10 mm	■ BO
	14x14x5 mm	■ BL
	14x14x14 mm	■ BP
	20x20x20 mm	■ BQ
	25x25x25 mm	■ BR
	8x8 mm	▲ BH (1)
	10x10 mm	▲ BI (1)

■ Kit Cubetti: 1 griglia + 1 disco taglio. - Dices: 1 grid + 1 cutting disc.
 ▲ Kit Patatine: 1 griglia + 1 disco speciale. - French fries: 1 grid + 1 special cutting disc.
 (1) Non disponibile per CL 55 a leva. - Not available for CL 55 lever.



Spremiagrumi
Citrus fruit squeezer
Zitruspresse
Presse agrumes
Exprimidor cítricos

art.	rpm	V	KW	kg.	dim. cm.	h.
49922-01	1500	220-240	0,13	5	20x30	35

Base in lega di alluminio, ogiva in policarbonato. Facile da pulire, ogiva, contenitore, griglia e filtro estraibili in un semplice movimento. Base uni-pezzo (blocco motore). Vassoio raccogli gocce in plastica, estraibile, 3 coni di spremitura (lime, limoni/arance, pompelmi). Altezza del becco 125 mm. Blocco motore resistente all'acqua. Elevata stabilità.

Aluminum alloy base and polycarbonate bowl. The whole bowl assembly including bowl, pips, filter grid and squeezer, can easily be taken out from the base in a simple movement. One piece base (motor block). Removable plastic drip tray, 3 removable squeezers (limes, lemons and oranges, grapefruits). Height of the spout 125 mm. Waterproof motor block. High stability.



Spremiagrumi
Citrus fruit squeezer
Zitruspresse
Presse agrumes
Exprimidor cítricos

art.	rpm	V	KW	kg.	dim. cm.	h.
49922-02	1500-1800	220-240	0,23	10	20,5x30,5	49

In alluminio pressofuso e acciaio inox. Ogiva e griglia filtro in acciaio inox. Particolarmente adatto per produzione continua. Facile da pulire: rapida rimozione dell'ogiva, griglia del filtro, cupola e spremiagrumi. 3 coni di spremitura (lime, limoni/arance, pompelmi). Cupola in policarbonato nero anti-spruzzi. Corpo inclinato per un migliore rendimento. Altezza del becco 212 mm. Produzione massima, circa 200 arance/h, 20 litri/h. Tutte le parti rimovibili sono lavabili in lavastoviglie.

Aluminum casting and stainless steel construction. Stainless steel bowl and filter grid. Particularly adapted for continuous production. Easy to clean: quick removal of the bowl, filter grid, dome and squeezer. 3 removable squeezers (limes, lemons and oranges, grapefruits). Black polycarbonate anti-splash dome. Inclined body for a better output. Height of the spout 212 mm. Maximum output approximately 200 oranges/hour, 20 liters/hour. All removable parts are dishwasher safe.



Spremiagrumi
Citrus fruit squeezer
Zitruspresse
Presse agrumes
Exprimidor cítricos

art.	rpm	V	KW	kg.	dim. cm.	h.
49922-03	1500-1800	220-240	0,23	10	20x30	38

In alluminio pressofuso e acciaio inox. Per arance, limoni e pompelmi. Basta tagliare la frutta in 2 parti e spremere. Estrae il massimo di succo per azione centrifuga. Leva start e stop. Tutte le parti a contatto con la frutta sono in inox. Facile da pulire. Rimozione rapida del filtro. Tutte le parti rimovibili sono lavabili in lavastoviglie.

Aluminum casting and stainless steel construction. For oranges, lemons and grapefruits. Just cut the fruit into 2 parts and squeeze. Extracts the maximum of juice by centrifugal action. Lever action start and stop. All parts in contact with fruit are stainless steel. Easy to clean. Quick removal of the perforated strainer. All removable parts are dishwasher safe.



Spremiagrumi
Citrus fruit squeezer
Zitruspresse
Presse agrumes
Exprimidor cítricos

art.	rpm	V	KW	kg.	dim. cm.	h.
49922-04	1500-1800	220-240	0,275	10	24x40	49

In alluminio pressofuso e acciaio inox. Per arance, limoni e pompelmi. Basta tagliare la frutta in 2 parti e spremere. Estrae il massimo di succo per azione centrifuga. Leva start e stop. Tutte le parti a contatto con la frutta sono in inox. Facile da pulire. Rimozione rapida del filtro. Tutte le parti rimovibili sono lavabili in lavastoviglie.

Aluminum casting and stainless steel construction. For oranges, lemons and grapefruits. Just cut the fruit into 2 parts and squeeze. Extracts the maximum of juice by centrifugal action. Lever action start and stop. All parts in contact with fruit are stainless steel. Easy to clean. Quick removal of the perforated strainer. All removable parts are dishwasher safe.



Centrifuga, spremisucchi
Juice extractor
Fruchtpresse
Centrifugeur-presse agrumes
Centrifugadora/exprimidor jugos

art.	rpm	V	KW	kg.	dim. cm.	h.
49922-06	3000-3300	220-240	0,8	16	26x47	45

Paniere di filtraggio con fori $\varnothing 0,5$ mm. Produzione continuata per azione centrifuga ed espulsione automatica della polpa. Altezza del becco 200 mm. Ad alto rendimento, più di 1 litro/minuto. Foro di carico circolare ($\varnothing 79$ mm). Non è necessario tagliare frutta e verdura. Struttura in acciaio inox. Sistema brevettato di bloccaggio-sbloccaggio con leva speciale. Tutte le parti rimovibili sono lavabili in lavastoviglie.

Standard basket is provided with $\varnothing 0,5$ mm holes. Continuous juice production by centrifugal action and automatic pulp ejection. Height of the spout 200 mm. High output more than 1 liter/minute. Wide circular feeding hole ($\varnothing 79$ mm.) no need to cut fruits or vegetables. Stainless steel bowl and base. Patented locking-unlocking system with special lever. Motor braking when opening. All removable parts are dishwasher safe.



Centrifuga, spremisucchi
Juice extractor
Fruchtpresse
Centrifugeur-presse agrumes
Centrifugadora/exprimidor jugos

art.	rpm	V	KW	kg.	dim. cm.	h.
49949-14	3000-3600	220-240	1,3	25	33x56,2	60,6

Tutte le parti a contatto con gli alimenti sono completamente in acciaio inox. Sistema brevettato Ezy-clean System II (coperchio, ciotola e cesto facilmente rimovibili). Non è necessario pre-tagliare frutta e verdura. Foro di carico circolare ($\varnothing 79,5$ mm). Resa 140 litri/h.

Full stainless steel food-zone, no aluminum, no plastic. Patented Ezy-clean System II (cover, bowl and basket are easily removable thanks to their new ergonomics). No pre-cutting needed, wide feeding chute $\varnothing 79.5$ mm. Extremely sturdy, no plastic in the shifter area, all in metal. Output up to 140l/h.



Spaccaghiaccio
Ice crusher
Eiszerstosser
Broyeur à glace
Triturador de hielo

art.	rpm	V	KW	kg.	dim. cm.	h.
49922-08	73-89	220-240	0,13	10	24x35	47

Dotato di sicurezza elettrica, termica e meccanica. 2 misure di tritatura. Funzionamento sia manuale che automatico (timer). Base in robusto ABS, alta stabilità. Capacità massima della tramoggia 1,3 kg. Produzione massima 160 fino a 300kg/h. circa. Illuminazione del ghiaccio tritato. Tutte le parti rimovibili sono lavabili in lavastoviglie.

Electrical, thermal and mechanical safety. Choose coarse or fine ice, electronic control unit. Both manual and automatic (timer). Heavy duty ABS base - high stability. Ice basket max. capacity 1,3 kg. Maximum output approximately 160 to 300kg/hour. Crushed ice lighting. All removable parts are dishwasher safe.



Frullino
Mixer
Quirl
Batteur
Mixer

art.	rpm	V	KW	kg.	dim. cm.	h.
49949-09	8000-16000	220-240	0,12	6	18x18	53

Corpo in alluminio pressofuso e acciaio inox. 2 bicchieri in acciaio inox e policarbonato capacità = 675 ml. Agitatori facilmente smontabili, avvitando e svitando il mandrino. Tutte le parti rimovibili sono lavabili in lavastoviglie.

Aluminum casting and stainless steel construction. Stainless steel bowl and polycarbonate bowl capacity = 0,675 lt. Easy removable agitators (tools) by simple screwing/unscrewing on the spindle. All removable parts are dishwasher safe.



Frullatore
Blender
Mixer
Mixeur
Mixer

Frullatore
Blender
Mixer
Mixeur
Mixer



art.	rpm	V	KW	kg.	dim. cm.	h.	lt.	art.	rpm	V	KW	kg.	dim. cm.	h.	lt.
49922-22	500-15000	220-240	1,2	11	30x22	56,6	2	49922-20	500-15000	220-240	1,2	11	30x22	56,6	2
49922-23	500-15000	220-240	1,2	11	30x22	56,6	4	49922-21	500-15000	220-240	1,2	11	30x22	56,6	4

Ideale per alberghi, bar, ristoranti, self-service, ospedali... Per miscelare, liquefare, emulsionare... tutti i tipi di alimenti e bevande. Trita rapidamente cubetti di ghiaccio. Velocità controllata da un processore elettronico che previene anche il surriscaldamento o il blocco dell'asse. Il contenitore può essere collocato in qualsiasi posizione. Lame in acciaio inox temperato. Sistema di bloccaggio-sbloccaggio con leva speciale brevettato. Tutte le parti rimovibili possono essere lavate in lavastoviglie. - Heavy duty appliance for hotels, bars, restaurants, cafeterias, hospitals... For blending, mixing, liquefying, emulsifying... all types of preparations of food and drink. Quickly crushes ice cubes. Speed is controlled by an electronic processor. This module also prevents overheating or blocking of the axle. Completely safe: locking system for bowl and lid. The container can be placed in any position. High duty tempered stainless steel blades and drive shaft parts, easy to dismount without tool. Patented locking-unlocking system with special lever. All removable parts are dishwasher safe.



Frullatore
Blender
Mixer
Mixeur
Batidora de vaso



Grattugia formaggio
Cheese grater
Käse-Raffelmaschine
Râpeur à fromage
Ralladora para queso



art.	V	KW	kg.	dim. cm.	h.	art.	rpm	V	KW	kg.	dim. cm.	h.
49922-09	220-240	3	9	20x47	44	49922-14	1500-1800	220-240	0,6	14	25x42	35

Blender ideale per la preparazione di qualsiasi tipo di cocktail, frullati, succhi di frutta, frappè, granite, caffè freddo, ecc., grazie alle sue 30 ricette pre-programmate. Per cubetti di ghiaccio, frutta, con o senza liquidi. Tutte le parti rimovibili possono essere lavate in lavastoviglie. Bicchiere senza BPA.

Blender for any kind of cocktails, smoothies, fruit juices, milkshakes, granitas, iced coffee, frappe, etc., thanks to its 30 pre-programmed recipes. Ergonomic sensitive glass control panel. For ice cubes, fruits, with or without liquid. All removable parts can be put in dishwasher or easily cleaned with hot soapy water. BPA-free jar.

Per formaggio, cioccolato, frutta secca, noccioline... Fornito con 1 disco standard per Gruyère con fori \varnothing 3 mm. Su richiesta dischi con fori: \varnothing 2, 4, 6, 8 mm. Corpo in alluminio pressofuso e acciaio verniciato. Produzione media 50 kg/h. Dotato di uno speciale contenitore in plastica (cassetto). Capacità 800 g. - For Cheese, chocolate, dried fruits, peanuts... Provided with 1 standard disc for Gruyere with \varnothing 3 mm holes. On request: \varnothing 2, 4, 6, 8 mm holes discs. Aluminum casting and painted steel housing. Average output 50 kg/hour. Provided with a special plastic container (drawer). Capacity 800 g.



Spremiagrumi
Citrus fruit squeezer
Zitruspresse mit Spritzschutz
Presse agrumes
Exprimidora

art.	rpm	V	KW	kg.	dim. cm.	h.
49958-00	1400	230	0,3	8	31x22	34

Recipiente in acciaio inox. Ogiva unificata per arance, limoni, pompelmi.
Stainless steel container. Universal shape for oranges, lemons, grapefruits.



Spremiagrumi a leva
Lever citrus fruit squeezer
Zitruspresse mit Pressarm
Presse agrumes à levier
Exprimidora

art.	rpm	V	KW	kg.	dim. cm.	h.
49959-00	1400	230	0,34	9	31x22	35

Messa in moto automatica a pressione. Apparato di spremitura in acciaio inox. Diametro filtro rotante: 110 mm. - Pressure sensitive automatic starter. Stainless steel squeezing set. Diameter of rotating filter: 110 mm.



Frullatore
Blender
Getränkemixer
Mixeur
Mixer

art.	rpm	V	KW	kg.	dim. cm.	h.
49956-01	10000>15000	230	400	4	20x20	46

Capacità bicchiere plastica 1,7 lt. Disponibile ricambio bicchiere plastica 1,7 lt art. 49956-AA oppure in inox art. 49956-AB. - Plastic glass capacity 1,7 lt. Available spare plastic glass item 49956-AA or in stainless steel item 49956-AB.



Frullatore
Blender
Getränkemixer
Mixeur
Mixer

art.	rpm	V	KW	kg.	dim. cm.	h.
49957-00	12000>22000	230	1	5,5	23x23	52

Capacità bicchiere inox 3 lt. - Stainless steel glass capacity 3 lt.



Tritaghiaccio automatico
Automatic ice crusher
Eiszerstosser
Broyeur à glace
Triturador de hielo automatico

art.	rpm	V	KW	kg.	dim. cm.	h.
49960-00	1400	230	0,34	11	42x21	29



Frullino
Drink Mixer
Getränkemixer
Shaker électrique
Batidora para batidos

art.	rpm	V	KW	kg.	dim. cm.	h.
49955-01	15000	230	0,12	2,8	20x22	50

Capacità bicchiere plastica 0,8 lt. Disponibile ricambio bicchiere plastica 0,8 lt. art. 49955-AA oppure in inox art. 49955-AB. - Plastic glass capacity 0,8 lt. Available spare plastic glass item 49955-AA or in stainless steel item 49955-AB.

**UTENSILI KITCHEN UTENSILS
APPARECCHI ELETTRICI ELECTRIC APPLIANCES**



Macchina per gelato, inox
Ice cream maker, stainless steel
Eismaschine, Edelstahl Rostfrei
Machine à glace, inox
Maquinas helado, inox

art.	dim. cm.	h.	kg.	V	KW	lt.	prod.
49949-19	51x31	35	30	220	0,4	1,5	3kg/h



Macchina per il ghiaccio
Ice maker
Eiswürfelmaschine
Machine à glaçons
Máquina de hielo

art.	resa/output	V	KW	kg.	dim. cm.	h.
49954-01	15kg/24h	220-240	0,2	21	43,5x38	43

Capacità serbatoio lt 4,5. Macchina dotata di rilevatore livello acqua e ghiaccio. - Tank 4,5 litres. Water and ice level detector device.



Disidratatore per frutta e verdura
Dehydrator for fruits and vegetables
Dehydratisierapparat
Déshydrateur fruits et légumes
Deshidratador de frutas y verduras

art.	dim. cm.	h.	kg.	V	KW
49953-02	43,5x29	21	3,6	220-240	0,53

Fornito con 6 vassoi reversibili. Temperatura regolabile da 30 a 80°C. Timer fino a 72 ore. Possibilità di utilizzare fino a 20 vassoi contemporaneamente. Supplied with 6 reversible trays. Adjustable temperature range from 30 to 80 °C. Timer up to 72 hours. Use up to 20 trays at a time.



Affumicatoio a 2 piani, HELIA
Smoker, 2 levels
Räucherofen
Fumoir
Ahumador

art.	dim. cm.	h.	V	KW	kg.
49850-63	45x45	35	230	1,5	25

Dotazione: vassoio raccogli liquidi cm 30x40 e teglia, griglia pesce e griglia piana cm 30x40, 1kg di segatura di faggio, spezie per pesce, libro di ricette con istruzioni d'uso. - Equipment: drip tray cm 30x40 and smoking pan, trout grill and flat grill cm 30x40, 1kg of sawdust beech, fish spices, recipe book with direction of use.



Impastatrice planetaria
Planetary mixer
Knet- u. Schlagmaschine
Batteur-mélangeur
Batodira planetaria

art.	rpm	V	KW	kg.	dim. cm.	h.
49947-08	1420	230	0,18	27	30x40	58

3 velocità planetaria 135-235-421 giri/min. Capacità vasca 7,6 lt. Timer 0-15 min. - 3 planetary speeds: 135-235-421 rpm. Bowl capacity 7,6 lt. Timer 0-15 min.

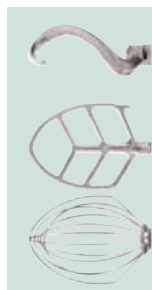

Tutti i modelli sono dotati di un selettore meccanico di velocità sulla parte superiore della macchina. Pos. 1-3 uncino - Pos. 4-7 spatola - Pos. 7-10 frusta - All models are equipped with a mechanical speed selector on the top of the machine. Pos. 1-3 hook - Pos. 4-7 spatula - Pos. 7-10 whip.



Impastatrice planetaria
Kitchen planetary mixer
Knet-u. Schlagmaschine
Batteur mélangeur
Batidora mezcladora

art.	rpm	V	KW	kg.	dim. cm.	h.
49945-05	40x260	230	0,75	15	38x31	45,5

10 velocità. Capacità vasca 5 lt. - 10 speeds. Bowl capacity 5 lt.



Tritacarne elettrico
Electric meat mincer
Elektr. Fleischwolf
Hachoir électrique
Tritador de carne, eléctrico

art.	dim. cm.	h.	kg.	V	KW
49921-00	18x42	43	6	220-240	0,35

Produzione 60-80 kg/h. Dotazione: 3 griglie ø 3, 5, 8 mm, 3 imbuto ø 12, 18, 21 mm, accessorio kébbé. - Output 60-80 kg/h. Equipment: 3 plates ø 3, 5, 8 mm, 3 funnels ø 12, 18, 21 mm, kébbé unit.



Tritacarne elettrico
Electric meat mincer
Elektr. Fleischwolf
Hachoir électrique
Tritador de carne, eléctrico

art.	dim. cm.	h.	kg.	V	KW
49920-00	18x35	38	3,2	220-240	0,2

Dotazione: 2 griglie ø 5, 7 mm, 3 imbuto ø 12, 18, 21 mm, accessorio kébbé. Equipment: 2 plates ø 5, 7 mm, 3 funnels ø 12, 18, 21 mm, kébbé unit.



Accessorio grattugia
Grater accessory
Raffel für Fleischwolf
Accessoire bloc râpeur
Accesorio ralladora

art.	kg.
49921-10	1,6

Dotazione 3 cilindri: verdure, parmigiano, gruviera. - Equipment 3 drums: rawness, parmesan, gruyère.



Affettatrice elettrica
Electric slicer
Elektr. Aufschnitt-Maschine
Trancheur électrique
Cortadora eléctrica

art.	ø cm.	dim.	h.	KW	kg.
49850-53	25	53x42	35	0,154	16
49850-54	27,5	63x49	41	0,176	20

Costruzione in lega speciale di alluminio anodizzata. Motore monofase ventilato. Affilatoio fisso. Regolazione spessore taglio da 0-15 mm. - Construction in special aluminum alloy, anodized. Built-in grinding device. Ventilated single phase motor. Adjustable cutting thickness 0-15 mm.



Affettatrice elettrica
Electric slicer
Elektr. Aufschnitt-Maschine
Trancheur électrique
Cortadora eléctrica

art.	ø cm.	dim.	h.	KW	kg.
49850-55	30	67x49	43	0,187	22,0
49850-56	35	73x48	53	0,22	28,5

Costruzione in lega speciale di alluminio anodizzata. Motore monofase ventilato. Affilatoio fisso. Regolazione spessore taglio da 0-15 mm.



Affettatrice elettrica
Electric slicer
Elektr. Aufschnitt-Maschine
Trancheur électrique
Cortadora eléctrica

art.	ø cm.	dim.	h.	KW	kg.
49850-57	30	63x48	51	0,22	25,5

Costruzione in lega speciale di alluminio anodizzata. Motore monofase ventilato. Affilatoio fisso. Regolazione spessore taglio da 0-15 mm.



Forno microonde, inox PROG
Microwave oven, stainless steel
Mikrowelle, Edelstahl Rostfrei
Four à micro-ondes, inox
Microonda, inox

art.	dim. cm.	h.	V	KW	kg.	lt.
49997-12	54,2x46,1	32,9	230	1,6	18	30

5 livelli di potenza, da 200 a 1000W. Fondo fisso in vetroceramica GN2/3. Esterno ed interno in acciaio inox. Tasto raddoppiamento tempo X2. Timer digitale sul display per un uso e monitoraggio più semplice. 3 stadi cottura e 5 livelli di potenza. 10 tasti programmabili. 20 programmi. - 5 power levels, from 200 to 1000W. Fixed glass ceramic bottom GN2/3. Outer and inner stainless steel. Key doubling time X2. Digital timer on the display for easy use and monitoring. 3 cooking stages, 5 power levels. 10 programmable keys. 20 programs.



Forno microonde, inox SELF
Microwave oven, stainless steel
Mikrowelle, Edelstahl Rostfrei
Four à micro-ondes, inox
Microonda, inox

art.	dim. cm.	h.	V	KW	kg.	lt.
49997-13	54,2x46,1	32,9	230	1,6	18	30

Il comando elettronico singolo lo rende particolarmente indicato per l'impiego nelle aree self-service. Fondo fisso in vetroceramica GN2/3. Esterno ed interno in acciaio inox. Tasto raddoppiamento tempo X2. Timer digitale sul display per un uso e monitoraggio più semplice. Tasto "START" preprogrammato "1 minuto" a piena potenza. Parametri preimpostati personalizzabili. - The electronic single control makes it particularly suitable for the use in self-service areas. Fixed glass ceramic bottom GN2/3. Exterior and interior in stainless steel. Key doubling time X2. Digital timer on the display for easy use and monitoring. "START" button preprogrammed "1 minute" at full power. Parameters customizable.



Piastra ad induzione, inox
Induction cooker, stainless steel
Induktionsplatte, Edelstahl Rostfrei
Plaque à induction, inox
Placa de inducción, inox

art.	dim. cm.	h.	V	KW	kg.
49998-03	48x58	13	230	2,8	10,8

La zona di cottura si autoadatta e riconosce automaticamente il diametro dell'utensile (da 12 a 36 cm). Comandi digitali a 12 livelli di potenza. - The cooking zone adapts itself and automatically recognizes the diameter of the pan (from 12 to 36 cm). Digital heat setting by 12 power levels.



Piastra ad induzione
Induction cooker
Induktionsplatte
Plaque à induction
Placa de inducción

art.	dim. cm.	h.	V	KW	kg.
58162-RA	30x37	10	220-240	0,5-2,7	6

Corpo inox, piano in vetroceramica Schott, display a led, timer 0-180 minuti, 1-10 livelli di potenza, temperatura 60-240°C. - Stainless steel body, Schott ceran hob, led display, timer (0-180 min.), 1-10 power levels, temperature range 60°C-240°C.



Piastra ad induzione, da incasso
Induction cooker, to be built into counter
Induktionsplatte, thekeneinbau
Plaque à induction, montage an comptoir
Placa de inducción para empotar

art.	dim. cm.	h.	V	KW	kg.
58162-RB	36x38	12,5	220-240	0,5-3,5	5,7

Piano in vetroceramica Schott, timer 0-180 minuti, 1-10 livelli di potenza, temperatura 60-240°C. - Schott ceran hob, timer (0-180 min.), 1-10 power levels, temperature range 60°C-240°C.



Piastra ad induzione, da incasso
Induction cooker, to be built into counter
Induktionsplatte, thekeneinbau
Plaque à induction, montage an comptoir
Placa de inducción para empotar

art.	dim. cm.	h.	V	KW
49998-20	35,5x35,5	6	230	2

5 livelli di potenza, selezione temperatura da 60 a 240°C, piano in vetroceramica Schott. - Digital heat setting by 5 power levels, temperature range from 60 to 240°C. Schott ceramic glass.



Piano cottura induzione, inox
 Induction cooker, stainless steel
 Induktionsplatte, Edelstahl Rostfrei
 Plaque à induction, inox
 Placa de inducción, inox

art.	dim. cm.	h.	V	KW	Hz
49998-02	39x45	7,2	230	3	50-60

Corona induzione ø 220 mm. - Dimensioni vetroceramica mm 390x370x4 - Pannello digitale ON/OFF, impostazione manuale della potenza (+/-) 20 posizioni da 50W a 3KW. Timer 99 minuti. Filtro lavabile. Doppia ventilazione. - Induction crown ø 220 mm. - Ceramic dimension mm 390x370x4 - Digital panel ON/OFF, manual power setting (+/-) 20 positions from 50W to 3KW. Timer 99 minutes. Washable filter. Double ventilation.



Piano cottura induzione, inox
 Induction cooker, stainless steel
 Induktionsplatte, Edelstahl Rostfrei
 Plaque à induction, inox
 Placa de inducción, inox

art.	dim. cm.	h.	V	KW	Hz
49998-04	53x45	7,5	230	3,5	50-60

Due corone ø210 mm. - Dimensioni vetroceramica mm 530x325x4 - Pannello digitale ON/OFF, impostazione manuale della potenza (+/-) 20 posizioni da 50W a 3,5KW. Timer. Filtro lavabile. Doppia ventilazione. Funzione "mantenitore temperatura" +/-70°C. - Two crowns ø210 mm. - ceramic dimension mm 530x325x4 - Digital panel ON/OFF, manual power setting (+/-) 20 positions from 50W to 3,5KW. Timer. Washable filter. Double ventilation. Function "temperature keeping" +/-70 °C.



Piano cottura induzione, inox
 Induction cooker, stainless steel
 Induktionsplatte, Edelstahl Rostfrei
 Plaque à induction, inox
 Placa de inducción, inox

art.	dim. cm.	h.	V	KW	Hz
49998-05	39x42	16	230	3,5	50-60

Corona induzione ø 280 mm. - Dimensioni vetroceramica ciotola wok dia. 310 mm. - Pannello digitale ON/OFF, impostazione manuale della potenza (+/-) 20 posizioni da 50W a 3,5KW. Timer 99 minuti. Filtro lavabile. Doppia ventilazione. - Induction crown ø 280 mm. - Ceramic wok bowl dia. 310 mm. - Digital control panel ON/OFF, manual power setting (+/-) 20 positions from 50W to 3,5KW. Timer 99 minutes. Washable filter. Double ventilation.



Piano caldo
 Warming plate
 Wärmeplatten
 Plaque chauffante
 Placa caliente

art.	dim. cm.	h.	V	KW
49999-01	50x35	6	230	0,30
49999-02	90x45	6	230	0,35
49999-03	100x50	6	230	0,45

Struttura in acciaio AISI 304. Termostato regolabile da +30° C a 90° C. Spia assorbimento. Interruttore luminoso. - Stainless steel structure AISI 304. Adjustable thermostat for temperature setting from +30° C to 90° C. Pilot light. ON/OFF light switch.



Vetrina riscaldata
 Warming display
 Warmhalte-Vitrine
 Vitrine chauffante
 Vitrina caliente

art.	dim. cm.	h.	V
49850-46	70x40	38	220

Piano caldo in acciaio AISI 304. Termostato regolabile da +30°C a +90°C. Spia assorbimento, interruttore luminoso, cupola in plexiglass stondata, antine apribili fronte e retro, griglia di appoggio in acciaio inox, estraibile. - Stainless structure in stainless steel AISI 304. Adjustable thermostat from +30°C to +90°C. Pilot light. ON/OFF light switch. Plexiglass cover, front and back opening. Removable stainless steel tray.



Vetrina riscaldata
 Warming display
 Warmhalte-Vitrine
 Vitrine chauffante
 Vitrina caliente

art.	dim. cm.	h.	V
49850-45	70x40	27	220



Cuoci riso a vapore
Rice steamer
Reiskocher
Cuit riz
Hervidor de arroz

art.	ø cm.	h.	lt.	V	KW	Kg riso/rice
49954-21	50	35	21	220	3	10



Vaporiera, inox
Steamer, stainless steel
Dampfer, Edelstahl Rostfrei
Cuit vapeur, inox
Olla para cocinar al vapor, inox

art.	ø cm.	h.	kg.	V	KW	lt.
49954-18	38	46	7	230	2	15

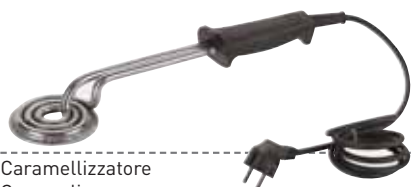

Caramellizzatore
Caramelizer
Caramelisier-Eisen
Carameliseur
Quemador eléctrico

art.	ø cm.	V	KW
47847-10	10	230	0,65
47847-12	12	230	1,00



Caramellizzatore
Caramelizer
Caramelisier-Eisen
Carameliseur
Quemador eléctrico

art.	l. cm.	V	KW
47847-23	23	230	1,5

Per qualsiasi tipo di prodotto da caramellare. Spolverare di zucchero semolato o zucchero a velo. Quando il caramellizzatore è incandescente, passare sul prodotto (creme, millefoglie, mousse, bavaresi, etc.). - For any product to be caramelized. Sprinkle with granulated sugar or icing sugar. When the caramelizer is white-hot pass it on the product (creams, puff pastries, mousses, Bavarians, etc.).



KIT TERMOMETRO PER SOTTOVUOTO
Sous vide cooking thermometer kit
PAGINA - Page: 102



Apparecchio per cottura sottovuoto
Soft cooker
Tauch-Sieder
Thermoplongeur
Máquina para cocinar al vacío

art.	dim. cm.	h.	V	KW	Kg
49851-10	16,4x22	22	230	0,2	7



Involucro completamente in acciaio inox, altezza minima del recipiente 167 mm, controllo elettronico della temperatura con precisione al 1/10°C (controllo a treno d'impulsi), temperatura regolabile da 0 a 99,9°C. Termostato di sicurezza, galleggiante di sicurezza per controllo acqua, altezza minima immersione resistenza 10 cm. Ideale per recipienti fino a 50 litri.



Case completely made of stainless steel, min. height of the tank 167 mm, electronic temperature control with 1/10°C precision (pulse train control), adjustable temperature from 0 up to 99,9°C, safety thermostat, waterline safety float, min. heating element immersion height 10 cm. Suitable for containers up to 50 liters.



KIT TERMOMETRO PER SOTTOVUOTO
Sous vide cooking thermometer kit
PAGINA - Page: 102



Bagnomaria sottovuoto, inox
 Water oven sous-vide, stainless steel
 Wassebad, Vakuunkocher, Edelstahl R.
 Bain-marie sous-vide, inox
 Baño maría para cocinar al vacío



Per cuocere gli alimenti a bagnomaria in buste sottovuoto. La temperatura è mantenuta precisamente costante e può essere regolata da 30°C a 100°C.
This appliance cooks food in vacuum-sealed pouches submerged in a water bath held at a precisely-controlled temperature from 30°C to 100°C.

art.	dim. cm.	h.	lt.	Kg	V	KW	Hz
49954-22	36x29,2	29	11	5,9	220-240	0,715-0,850	50-60



Macchina sottovuoto
 Vacuum machine
 Vakuumiergerät
 Machine pour l'emballage sous-vide
 Máquina para el envasado al vacío

art.	dim. cm.	h.	kg.	V	KW
49952-00	38x25	10,5	4	230	0,2
49952-AA	28x35	sacchetti/vacuum bags			pz/pcs 25
49952-AB	13x55	sacchetti/vacuum bags			pz/pcs 30
49952-AC	28x20	sacchetti/vacuum bags			pz/pcs 40

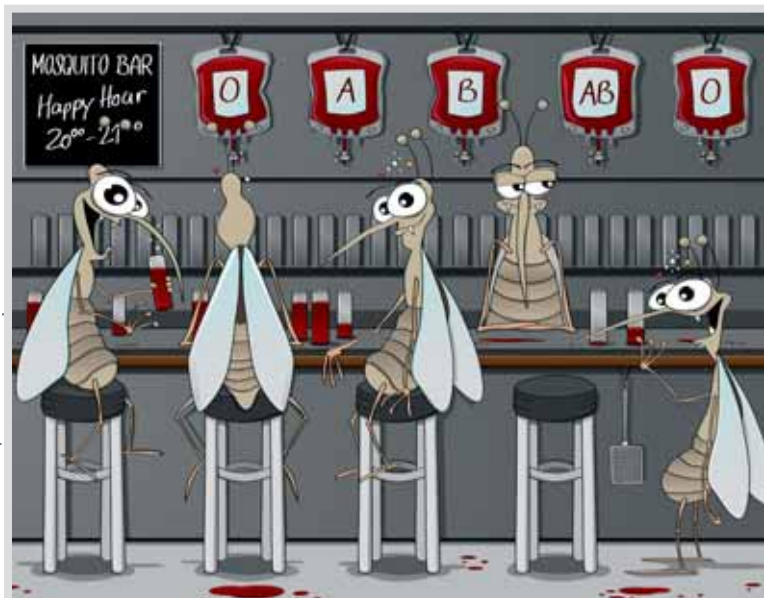

Lampade insetticida. Costruzione in acciaio inox. Tubi UV actinici a lunga durata (1 anno). Cavo d'alimentazione mt 1,20. 230 Volts, 50-60 Hz. Per la distruzione degli insetti volanti, ideali per le cucine e per il commercio alimentare. Griglia interna ad alta tensione e griglia di protezione in filo inox. Vaschetta recupero inox.

Insect killer lamps. Stainless steel construction. UV actinic tube, long lasting (1 year). Cable length 1,20 m. 230 Volts, 50-60 Hz. For the destruction of flying insects, ideal for kitchens and food trade locations. Internal high-voltage grid and grid protection in stainless steel wire. Stainless steel recovery tank.



Sterminatore elettrico murale
 Wall mounting electric insect killer
 Insektenvernichter
 Désinsectiseur électrique mural
 Exterminador de insectos

art.	dim. cm.	h.	W	m ²
49791-50	61,5x14,2	28,5	40	50



Sterminatore elettrico sospeso
 Electric insect killer
 Insektenvernichter
 Désinsectiseur électrique suspendus
 Exterminador de insectos

art.	dim. cm.	h.	W	m ²
49792-09	61,5x11	33,0	2x20	90

PIZZA E PANE *PIZZA & BREAD*





Oliera, inox
Oil pourer, stainless steel
Oelständer, Edelstahl Rostfrei
Huilière, inox
Alcuza, inox

art.	lt.
41780-07	0,75
41780-10	1,00
41780-15	1,50
41780-20	2,00



Oliera, rame
Oil pourer, copper
Oelständer, Kupfer
Huilière, cuivre
Alcuza, cobre

art.	lt.
41781-05	0,5
41781-10	1,0

Interno stagnato. - *Tinned inside.*



Oliera, rame
Oil pourer, copper
Oelständer, Kupfer
Huilière, cuivre
Alcuza, cobre

art.	lt.
41781-15	1,5

Interno stagnato. - *Tinned inside.*



Pala pizza, alluminio
Pizza peel, aluminum
Pizzaschaufel, Aluminum
Pelle à pizza, aluminum
Pala pizza, aluminio

art.	ø cm.	l.	gr.
11701-02	32	150	736
11701-06	37	150	870
11701-10	41	150	1226
11701-13	45	150	1460
11701-16	50	150	1604



Pala pizza, alluminio
Pizza peel, aluminum
Pizzaschaufel, Aluminum
Pelle à pizza, aluminum
Pala pizza, aluminio

art.	dim. cm.	l.	gr.
11702-02	32x32	150	784
11702-06	37x37	150	894
11702-10	41x41	150	1246
11702-16	50x50	150	1694

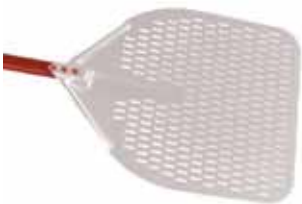

Pala pizza forata, alluminio
Perforated pizza peel, aluminum
Pizzaschaufel, gelocht, Aluminum
Pelle à pizza perforée, aluminum
Pala pizza perforada, aluminio

art.	dim. cm.	l.	gr.
11704-02	32x32	150	700
11704-06	37x37	150	816
11704-13	45x45	150	1250
11704-16	50x50	150	1409



Palettino, inox
Pizza peel, small, stainless steel
Pizzaschaufel, klein, Edlsthil Rostfrei
Petite pelle à pizza, inox
Pala pizza, pequeña, inox

art.	ø cm.	l.	gr.
11705-02	17	150	780
11705-06	20	150	846
11705-10	23	150	938
11705-14	26	150	984



Palettino forato, inox
Perforated pizza peel, small, s/s
Pizzaschaufel, gelocht, klein, Edlsthil
Petite pelle à pizza perforée, inox
Pala pizza perforada, pequeña, inox

art.	ø cm.	l.	gr.
11706-02	17	150	770
11706-06	20	150	830
11706-10	23	150	912
11706-14	26	150	954



Pala per infornare, alluminio
Oven pizza peel, aluminum
Back-Pizzaschaufel, Aluminum
Pelle à enfourner, aluminum
Pala para hornear, aluminio

art.	dim. cm.	l.	gr.
41765-32	32x32	150	1200
41765-37	37x37	150	1400
41765-41	41x41	150	1500
41765-45	45x45	150	1600
41765-50	50x50	150	1700



Pala per infornare, inox
Oven pizza peel, stainless steel
Back-Pizzaschaufel, Edlsthil
Pelle à enfourner, inox
Pala para hornear, inox

art.	ø cm.	l.	gr.
41735-29	29	150	870

Manico alluminio. - *Aluminum handle.*



Pala per infornare, alluminio
Oven pizza peel, aluminum
Back-Pizzaschaufel, Aluminum
Pelle à enfourner, aluminum
Pala para hornear, aluminio

art.	dim. cm.	l.	gr.
41736-32	32x30	150	954



Palettino forato, inox
Perforated pizza peel, small, s/s
Pizzaschaufel, gelocht, klein, Edelstahl
Petite pelle à pizza perforée, inox
Pala pizza perforada, pequeña, inox

art.	ø cm.	l.	gr.
41737-17	17	150	890
41737-20	20	150	910
41737-23	23	150	960



Palettino, inox
Pizza peel, small, stainless steel
Pizzaschaufel, klein, Edelstahl Rostfrei
Petite pelle à pizza, inox
Pala pizza, pequeña, inox

art.	ø cm.	l.	gr.
41738-17	17	150	905
41738-20	20	150	975
41738-23	23	150	1030



Palettino, alluminio
Pizza peel, small, aluminum
Pizzaschaufel, klein, Aluminum
Petite pelle à pizza, aluminum
Pala pizza, pequeña, aluminio

art.	ø cm.	l.	gr.
41735-20	20	150	800

Manico zincato. - Galvanized handle.



Pala pizza, legno
Pizza peel, wood
Pizzaschaufel, Holz
Pelle à enfourner, bois
Pala pizza, madera

art.	ø cm.	l.
41764-28	28	125
41764-33	33	200
41764-40	40	200



Paletta cenere, inox
Ash shovel, stainless steel
Asche-Schaufe, Edelstahl Rostfrei
Pelle à cendres, inox
Paleta recoger cenizas, inox

art.	dim. cm.	l.
41768-21	21x31	173



Rastrello, inox
Rake, stainless steel
Harke, Edelstahl Rostfrei
Râteau, inox
Rastrillo, inox

art.	dim. cm.	l.
41768-22	24x10	150



Spazzola orientabile
Adjustable brush
Drehbare Bürste
Brosse orientable
Cepillo orientable

art.	dim. cm.	l.
41767-20	20x6,5	155

Setole ottone. - Brass bristles.



Spazzola orientabile
Adjustable brush
Drehbare Bürste
Brosse orientable
Cepillo orientable

art.	dim. cm.	l.
41766-27	27x7	150

Setole ottone. - Brass bristles.



Spazzola orientabile
Adjustable brush
Drehbare Bürste
Brosse orientable
Cepillo orientable

art.	dim. cm.	l.
41766-16	16x5	110

Setole ottone. - Brass bristles.



Spazzola orientabile
Adjustable brush
Drehbare Bürste
Brosse orientable
Cepillo orientable

art.	dim. cm.	l.
41766-14	14x7	150

Setole ottone. - Brass bristles.



Spazzola orientabile
Adjustable brush
Drehbare Bürste
Brosse orientable
Cepillo orientable

art.	dim. cm.	l.
41739-20	20x6,6	150

Setole naturali. - Natural bristles.



Spazzola per griglia, setole in acciaio
Stainless steel brush for grill cleaning
Grillenbürste mit Stahlborsten
Brosser pour grille avec soies en acier inox
Cepillo para parrilla con cerdas de acero

art.	dim. cm.
41740-00	27x4x15



Poggia pala pizza, inox
Support for peels, stainless steel
Schaufelträger aus Edelstahl
Support inox pour pelles à pizza
Portapala para palas, inox

art.	dim. cm.	kg
41769-36	41x16x39	3,0 fino/up to 36 cm
41769-50	53x16x39	3,5 fino/up to 50 cm



Portapaleto da muro, alluminio
Small pizza peel wall rack, aluminum
Pizzaschaufel-Wandgestell, Aluminum
Support mural petite pelle, aluminum
Soporte mural de pala pizza, aluminio

art.
41769-02



Appendi pala da muro, alluminio
Pizza peel wall rack, aluminum
Pizzaschaufel-Wandgestell, Aluminum
Support mural pour pelle, aluminum
Soporte mural de pala pizza, aluminio

art.
41769-01



Porta pale, inox
Pizza peel rack, stainless steel
Ständer für Schaufeln, Edelstahl
Support pour pelles, inox
Soporte para pala, inox

art.	h. cm.	kg
41769-00	172	14



Pinza per teglie, inox
Pizza-sheet tongs, stainless steel
Pizzablech-Zange, Edelstahl Rostfrei
Pince à plaques, inox
Pinza fuente horns, inox

art.	l. cm.
18323-00	23
42822-00	19



Tronchetto tagliapizza, inox
Pizza cutter, stainless steel
Pizzaschneider, Edelstahl Rostfrei
Coupe-pizza, inox
Cortador de pizza, inox

art.	ø cm.	l.
18324-00	13,5	19



Tagliapasta, PS
Dough cutter, PS
Teigschäber, PS
Raclette, PS
Rascador, PS

art.	dim. cm.
47621-11	10x24



Tagliapasta, PS
Dough cutter, PS
Teigschäber, PS
Raclette, PS
Rascador, PS

art.	dim. cm.
47621-12	13,5x14,5

Materiale antiurto e antigraffio. Non usare su fonti di calore.
Shock and scratchproof material. Do not use on heat sources.



Forbice pizza smontabile, inox
Divisible pizza scissors, stainless steel
Pizzaschere, teilbar, Edelstahl Rostfrei
Ciseaux à pizza, divisible, inox
Tijeras para pizza desmontables, inox

art.	l. cm.
18276-00	25



Rotella taglia pizza, inox
Pizza wheel, stainless steel
Pizzaschneider, Edelstahl Rostfrei
Roulette à pizza, inox
Ruleta cortapizzas, inox

art.	ø cm.
18324-10	10



Coltello per pizzaiolo, inox
Pizza knife, stainless steel
Pizzamesser, Edelstahl Rostfrei
Couteau à pizza, inox
Cuchillo para pizza, inox

art.	l. cm.
48280-45	23



Vassoio rotondo liscio, legno di faggio
Round tray, benchwood
Rindes Buchenholzbrett
Plateau ronde plat, bois d'hêtre
Bandeja redonda lisa, madera de haya

Vassoio rotondo spicchiato, legno
Round tray with guides, benchwood
Hackbrett
Plateau ronde avec glissières, bois d'hêtre
Bandeja redonda con guías, madera de haya

Tagliere monoporzione, faggio
Cutting board for 1 portion, benchwood
Einzelportion Tablett, Buche
Planche mono-portion, d'hêtre
Tabla monoporción, haya

art.	ø cm.
41774-33	33
41774-40	40
41774-45	45
41774-50	50

art.	ø cm.	pcs
41775-45	45	6
41775-50	50	8

art.	dim. cm.
41775-34	34x20



Pala manicata, alluminio
Peel with handle, aluminum
Schaufel mit Griff, Aluminium
Pelle avec manche, alu
Pala con mango, alluminio

Pala manicata, alluminio
Peel with handle, aluminum
Schaufel mit Griff, Aluminium
Pelle avec manche, alu
Pala con mango, alluminio

Pala manicata, forata, inox
Perforated peel with handle, s/s
Schaufel mit Griff, gelocht, Edelstahl
Pelle perforée avec manche, inox
Pala con mango, perforada, inox

art.	ø cm.
42826-32	32
42826-37	37
42826-41	41
42826-45	45

art.	ø cm.	pcs
42827-01	45	6
42827-02	45	8
42827-03	50	6
42827-04	50	8

art.	dim. cm.
18302-01	22x18



Pala manicata, inox
Peel with handle, stainless steel
Schaufel mit Griff, Edelstahl Rostfrei
Pelle avec manche, inox
Pala con mango, inox

Paletta triangolare, forata, inox
Perforated spatula, stainless steel
Palette, gelocht, Edelstahl Rostfrei
Palette perforée, inox
Pala triangolar perforada, inox

Paletta triangolare, inox
Spatula, stainless steel
Palette, Edelstahl Rostfrei
Palette, inox
Pala triangular, inox

art.	dim. cm.
18302-02	22x18

art.	dim. cm.
18301-01	12x15

art.	dim. cm.
18301-02	12x15



Mestolo pizza, fondo piatto
Pizza ladle, flat bottom
Schöpflöffel, flachboden
Louche fond plat
Cacillo fondo plano

art. ø cm. l.
12968-10 10 27

PA⁺
plus



Tagliapasta flessibile, inox
Dough scraper, flexible, stainless steel
Abstecher, flexibele, Edelstahl Rostfrei
Raclette flexible, inox
Cortapastas flexible, inox

art. dim. cm.
18501-02 12x9,5



Tagliapasta, inox
Dough scraper, stainless steel
Abstecher, Edelstahl Rostfrei
Raclette, inox
Cortapastas, inox

art. dim. cm.
18501-01 12x16
18501-03 13,5x10
18501-04 12x9,5

P



Raschia, inox
Dough scraper, stainless steel
Teigschäber, Edelstahl Rostfrei
Raclette, inox
Rasqueta, inox

art. dim. cm.
18501-05 11x19,5

P



Raschia, inox
Dough scraper, stainless steel
Teigschäber, Edelstahl Rostfrei
Raclette, inox
Rasqueta, inox

art. dim. cm.
18502-18 18x9



Raschia, inox
Dough scraper, stainless steel
Teigschäber, Edelstahl Rostfrei
Raclette, inox
Rasqueta, inox

art. dim. cm.
18503-12 12x10

P



Raschia, inox
Dough scraper, stainless steel
Teigschäber, Edelstahl Rostfrei
Raclette, inox
Rasqueta, inox

art. dim. cm.
18504-15 15x7,5

P



Raschia, inox
Dough scraper, stainless steel
Teigschäber, Edelstahl Rostfrei
Raclette, inox
Rasqueta, inox

art. dim. cm.
18520-15 15x6

P



Borsa termica
Pizza delivery bag
Thermischetasche
Sac thermique
Bolsa térmica

art. dim. cm. Kg.
44960-06 35x35x20 0,6

Per 5 pizze ø33 cm. in cartone, in robusto tessuto lavabile. Imbottitura per il mantenimento della temperatura, anelli di sfiato per la condensa. - Holds up to 5 pizza ø33 cm. boxes. Made in heavy tissue, washable. Foam padding for insulation and holes for steam ventilation.



Contenitore per impasti, impilabile, PP
Box for dough, stackable, PP
Behälter für Pizzateig, stapelbar, PP
Récipient à pétrissage, empilable, PP
Contenedor para masa de pizza, apilable, PP

art. dim. cm. h.
41762-07 60x40 7
41762-09 60x40 9
41762-13 60x40 13



Coperchio per contenitore, PP
Cover for dough box, PP
Deckel für Pizzateig-Behälter, PP
Couvercle pour récipient à pétrissage, PP
Tapa para contenedor, PP

art. dim. cm.
41763-00 60x40



Retina pizza, alluminio
Pizza screen, aluminum
Pizzanetzscheibe, Aluminum
Toile à pizza, aluminum
Red para pizza, aluminio

art. dim. cm.
41734-60 40x60



BASE E COPERCHIO
BASE AND LID
44975-35



ESTENSORE
EXTENDER
44975H35



BASE E COPERCHIO
BASE AND LID
44975-50



BASE E COPERCHIO
BASE AND LID
44975-50



ESTENSORE
EXTENDER
44975H50



BASE E COPERCHIO
BASE AND LID
44975-50

Contenitore isotermico **PIZZA**
Insulated container
Thermobehälter
Conteneur isotherme
Contenedor isotérmico

art.	cm. ext.	cm. int.	
44975-35	41x41x7,5	35x35x7,5	Base e coperchio/Base and lid
44975H35	41x41x7,5	35x35x4,5	Estensore/Extender

Contenitore isotermico **PIZZA**
Insulated container
Thermobehälter
Conteneur isotherme
Contenedor isotérmico

art.	cm. ext.	cm. int.	
44975-50	57x57x10,5	51x51x10,5	Base e coperchio/Base and lid
44975H50	57x57x10,5	51x51x6,3	Estensore/Extender

PIZZA FAMILY
50 X 50 CM



PIZZA SINGLE
35 X 35 CM



Il sistema modulare dove base e coperchio sono lo stesso elemento e grazie all'inserto estensore è possibile aumentare la capacità.
The modular system where the base and lid are the same element and due to the extender insert it is possible to increase capacity.



Teglia forno, acciaio alluminizzato
Baking sheet, alusteel
Stahlblech mit Aluminumüberzug
Plaque à pizza, tôle aluminisée
Placa pizza, acero aluminizado

art.	ø cm.	h.	u.pack
11739-20	20	2,5	5
11739-24	24	2,5	5
11739-28	28	2,5	5
11739-32	32	2,5	5



Teglia pizza, ferro blu pesante
Heavy pizza blue steel sheet
Pizzablech, Blaublech, Schwerausführung
Plaque à pizza, tôle forte bleuie
Placa pizza, hierro pesante

art.	ø cm.	h.	u.pack
11744-20	20	2,5	10
11744-24	24	2,5	10
11744-28	28	2,5	10
11744-32	32	2,5	10

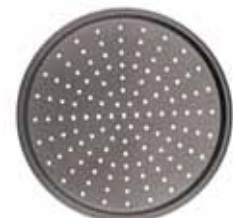

Teglia pizza forata, antiaderente
Perforated pizza sheet, non stick coated
Pizza-Blech, gelocht, beschichtet
Plaque à pizza perforée, anti-adhésive
Placa pizza perforada, antiadherente

art.	ø cm.	h.
41729-30	30	1,3
41729-34	34	1,3

UTENSILI KITCHEN UTENSILS



Retine pizza, alluminio
Pizza screens, aluminum
Pizzanetzscheiben, Aluminum
Toiles à pizza, aluminum
Red para pizza, aluminio

art.	ø cm.
41727-28	28
41727-30	30
41727-33	33
41727-36	36
41727-40	40
41727-45	45
41727-50	50
41727-55	55
41727-60	60

Senza giunzione. - Without seam.



Rastrelliera per retine, inox
Pizza screen rack, stainless steel
Pizzanetzscheiben-Träger, Edelstahl
Etagère à toiles, inox
Rack para red para pizza, inox

art.	dim. cm.
41771-96	23x35,6

Può contenere 96 retine.
Suitable for 96 pizza screens.



Rastrelliera per teglie pizza, inox
Pizza pan rack, stainless steel
Pizzableche-Träger, Edelstahl
Etagère pour plaques à pizza, inox
Rack para placas pizza, inox

art.	dim. cm.	h.
41770-15	30,5x30,5	70

Distanza fra i piani cm 3,5, per teglie fino a ø 36 cm. - Height between rails cm 3,5, suitable for baking sheets up to ø 36 cm.



Teglia pizza, antiaderente a 2 strati
Pizza sheet double non stick-coating
Pizzablech mit Doppel-Beschichtung
Plaque à pizza, double revêtement
Placa pizza antiadherente, 2 capas

art.	ø cm.	h.	u.pack
11741-20	20	2,5	5
11741-24	24	2,5	5
11741-26	26	2,5	5
11741-28	28	2,5	5
11741-32	32	2,5	5

Teglia ad alta prestazione, resistente a 280 °C. - High performance sheet, heat resistant up to 280°C.



Teglia pizza, ferro blu
Pizzasheet, blue steel
Pizza-Blaublech
Plaque à pizza, tôle bleuie
Placa pizza, hierro

art.	ø cm.	h.	u.pack
11740-14	14	2,5	5
11740-16	16	2,5	5
11740-18	18	2,5	5
11740-20	20	2,5	5
11740-22	22	2,5	5
11740-24	24	2,5	5
11740-26	26	2,5	5
11740-28	28	2,5	5
11740-30	30	2,5	5
11740-32	32	2,5	5
11740-36	36	2,5	5
11740-40	40	2,5	5



Teglia pizza, ferro blu
Pizzasheet, blue steel
Pizza-Blaublech
Plaque à pizza, tôle bleuie
Placa pizza, hierro

art.	ø cm.	h.	u.pack
11742-16	16	3,5	10
11742-18	18	3,5	10
11742-20	20	3,5	10
11742-22	22	3,5	10
11742-24	24	3,5	10
11742-26	26	3,5	10
11742-28	28	3,5	10
11742-30	30	3,5	10
11742-32	32	3,5	5
11742-36	36	3,5	5
11742-40	40	3,5	5
11742-45	45	3,5	5
11742-50	50	3,5	5
11742-60	60	3,2	5



Teglia rettangolare, ferro blu
Blue steel baking sheet, rectangular
Rechteckiges Blaublech
Plaque rectangulaire, tôle bleuie
Placa rectangular, hierro

art.	dim. cm.	h.
41745-30	30x23	3
41745-35	35x28	3
41745-40	40x30	3
41745-50	50x35	3
41745-60	60x40	3
41745-65	65x45	3



Teglia, alluminata
Baking sheet, alusteel
Rechteckiges Blech, Aluminumüberzug
Plaque rectangulaire, tôle aluminitée
Placa rectangular, acero aluminizado

art.	dim. cm.	h.
41746-60	60x40	2



Teglia, alluminata
Baking pan, alusteel
Backblech, Aluminumüberzug
Plaque, tôle aluminitée
Placa, acero aluminizado

art.	dim. cm.	h.
41751-30	30x23	3
41751-35	35x28	3
41751-40	40x30	3
41751-50	50x35	3
41751-60	60x40	3
41751-65	65x45	3



Teglia forata, alluminio
Perforated aluminum baking tray
Aluminum Backbleche, gelocht
Plaque à cuisson perforée, aluminium
Placa pastelería perforada, aluminio

art.	dim. cm.	GN
41756-30	30x40	
41756-32	32,5x53	1/1
41756-53	53x65	2/1
41756-60	60x40	



Teglia rettangolare, antiaderente
Baking sheet, non stick coated
Blech mit Antihafbeschichtung
Plaque avec revêtement anti-adhésif
Placa pastelería anti-adherente

art.	dim. cm.	h.
41747-60	60x40	2



Teglia GN, antiaderente
Baking pan, GN, non stick coated
Backblech, GN, beschichtet
Plaque GN, revêtement anti-adhésif
Placa GN, antiadherente

art.	GN	ø cm.	pcs
41755-11	1/1	12,5	6



Teglia, alluminata
Baking pan, alusteel
Backblech, Aluminumüberzug
Plaque, tôle aluminitée
Placa, acero aluminizado

art.	dim. cm.	ø	pcs
41752-08	60x40	14	8
41752-12	60x40	12	12
41752-24	60x80	12	24



Bacinella carré, ferro blu
Blue steel bread mould
Brotform, Blaublech
Pain de mie, tôle bleuie
Molde, hierro

art.	dim. cm.	h.
41748-20	20x10	10
41748-30	30x10	10
41748-35	35x10	10
41748-40	40x10	10
41748-50	50x10	10



Bacinella carré, alluminata
Bread mould, alusteel
Brotform mit Aluminumüberzug
Pain de mie, tôle aluminitée
Molde, acero aluminizado

art.	dim. cm.	h.
41750-20	20x10	10
41750-30	30x10	10
41750-40	35x10	10
41750-41	40x10	10
41750-50	50x10	10



Teglia alluminio forato, siliconata
Sheet for French loaves, perforated, silicone coated
Pariserbrotblech, Silikon-beschichtet
Plaque perforée à pain parisien, siliconée
Placa perforada para pan, siliconada

art.	dim. cm.	canali/halfpipe
41758-53	53x32	4
41758-60	60x40	5
41758-65	65x43	6
41758-85	85x43	6



Supporti di cottura Silform® specifici per pane, antiaderenti, ideali per panini tondi, hot dogs, panini al latte, per hamburger, baguettes, ecc., ecc. La loro texture perforata ottimizza il trasferimento del calore per una perfetta croccantezza e doratura del prodotto. Si utilizzano indifferentemente su teglie in alluminio o griglie.

Silform® baking sheets are especially studied for breads, non-stick and ideal for a variety of small bread shapes: round, hot-dogs rolls, soft rolls, submarines, hamburger buns, sandwiches, etc., ect. Thanks to their perforated texture, the heat transfer is optimized, allowing unique crunchy and coloration. Can be used indifferently on aluminum baking trays or grids.

Rotondi - Round

art.	dim. cm.	ø mm.	h.	ml.	pcs
41759-01	60x40	67	15	48	28
41759-02	60x40	75	17	65	24
41759-03	60x40	79	15	65	24
41759-05	60x40	102	20	140	15
41759-09	60x40	125	16	175	11

Ovali - Ovals

art.	dim. cm.	dim. mm.	h.	ml.	pcs
41760-02	60x40	95x40	30	80	24
41760-05	60x40	155x41	25		18
41760-06	60x40	169x64	30		12
41760-08	60x40	259x64	30		8
41760-09	60x40	299x60	30		6





Stampo per pane
Bread mould
Brot-Ausstechforme
Découpoir à pain
Cortador para pan

art. dim. cm.
47041-01 14x10



Stampo per pane
Bread mould
Brot-Ausstechforme
Découpoir à pain
Cortador para pan

art. dim. cm.
47041-02 14x10



Stampo per pane
Bread mould
Brot-Ausstechforme
Découpoir à pain
Cortador para pan

art. Ø cm.
47041-03 12,5



Stampo per pane
Bread mould
Brot-Ausstechforme
Découpoir à pain
Cortador para pan

art. dim. cm.
47041-04 16,5x8,5



Stampo per pane
Bread mould
Brot-Ausstechforme
Découpoir à pain
Cortador para pan

art. Ø cm.
47041-05 12,5



Stampo per pane
Bread mould
Brot-Ausstechforme
Découpoir à pain
Cortador para pan

art. Ø cm.
47041-06 8



Stampo per pane
Bread mould
Brot-Ausstechforme
Découpoir à pain
Cortador para pan

art. Ø cm.
47041-07 8



Stampo per pane
Bread mould
Brot-Ausstechforme
Découpoir à pain
Cortador para pan

art. Ø cm.
47041-08 8



Stampo per pane
Bread mould
Brot-Ausstechforme
Découpoir à pain
Cortador para pan

art. Ø cm.
47041-15 8



Marcatore girevole per pane Kaiser
Kaiser bread marker
Kaiserbrot Stempel
Empreinte pour pain Kaiser
Molde para pan Kaiser

art.
47040-00





Spazzola pane
Bread brush
Brot-Bürste
Brosse à pain
Cepillo para pan

art.	l. cm.	file/rows
42614-04	24,5	4
42614-05	32,0	5
42614-06	41,0	6
42614-07	46,0	7



Lame panettiere usa e getta, inox
Disposable baker's blades, s/s
Einweg-Bäcker-Klingen, Edelstahl
Incisette boulanger jetables, inox
Láminas del panadero un solo uso, inox

art.	l. cm.	pz/pcs
48290-10	12	10



Cesta pane impilabile, polietilene
Bread basket, stackable, LLDPE
Brot-Korb, stapelbar, LLDPE
Corbeille à pain, empilable, LLDPE
Cesta pan, apilable, LLDPE

art.	dim. cm.	h.	lt.
44982-04	57x36	34	40
44982-06	66x45	35	60
44982-10	78x52	40	100



Cestino impasto, PP
Bread proofing basket, PP
Brotformen, PP
Banneton, PP
Molde para pan, PP

art.	Ø cm.	h.	gr.
47042-19 ●	19	7,5	500
47042-22 ●	22	9,3	1000
47042-25 ●	25	9,0	1500



Cestino impasto, PP
Bread proofing basket, PP
Brotformen, PP
Banneton, PP
Molde para pan, PP

art.	dim. cm.	h.	gr.
47043-27 ●	27x12	6,5	500
47043-35 ●	35x13	7,2	1000
47043-42 ●	42x14	7,5	1500



NORME D'USO E MANUTENZIONE DELLE TEGLIE

Importante: Indipendentemente dal tipo di materiale, tutte le teglie piane non vanno mai infornate vuote.

Teglie in lamiera bluita (ferro blu)

I prodotti vengono forniti oleati in modo tale che in condizioni normali di imballaggio, trasporto, manipolazione e immagazzinaggio non presentino fenomeni di corrosione per un periodo non superiore a 3 mesi. Prima dell'uso vanno messi nel forno a 150°C per mezz'ora in modo tale da eliminare l'olio industriale di protezione. Dopo l'uso devono essere mantenuti sempre oleati e conservati in luoghi asciutti, soprattutto se utilizzati saltuariamente e deve essere evitato il contatto con sostanze acide. Sconsigliato l'uso in cella di lievitazione e surgelazione. Per la pulizia utilizzare un panno morbido oleato. Sconsigliato il lavaggio con acqua e soluzioni caustiche.

Teglie in lamiera alluminata

Devono essere mantenute oleate ma essendo la lamiera trattata e rivestita di alluminio presentano una maggiore resistenza all'ossidazione. Prima dell'uso vanno messe nel forno a 150°C per mezz'ora in modo tale da eliminare l'olio industriale di protezione. Possono essere utilizzate in cella di lievitazione e surgelazione. Per la pulizia utilizzare un panno morbido oleato. Sconsigliato il lavaggio con acqua e soluzioni caustiche.

Teglie in alluminio

Non presentano particolari problemi di mantenimento. Le caratteristiche meccaniche dell'alluminio possono alterarsi ad una temperatura superiore ai 300°C, solitamente non raggiunta dai forni. Per la pulizia utilizzare un panno morbido inumidito.

Teglie antiaderenti

Per la pulizia utilizzare il getto d'aria o delle spazzole di nylon morbide. Non graffiare il rivestimento con attrezzi metallici o spazzole abrasive in quanto le incisioni possono dar luogo a permeazione ed in seguito a corrosione. Non mettere gli stampi vuoti nel forno di cottura a temperature superiori a 200°C. Questa temperatura rappresenta il limite di resistenza termica della resina. Oltre a tale temperatura il rivestimento rammollisce sensibilmente portando ad un decadimento rapido delle caratteristiche di antiaderenza. Non lavare le teglie con pulivapor ad alta pressione e non utilizzare soluzioni caustiche. Per la pulizia utilizzare panni morbidi inumiditi.

BAKING SHEET USAGE AND MAINTENANCE INSTRUCTIONS

Important: Quite apart from the material baking sheets are made of, never put them empty in the oven.

Blue steel baking sheets

Blue steel baking sheets are supplied oiled, in order to prevent corrosion for a period of about 3 months under normal packing, transport, handling and stocking conditions. Before use, put them at 150°C in the oven for half an hour, in order to eliminate the protective industrial oil. After usage keep them oiled and dry-stored, mainly if sporadically used. Keep away from acid substances. We suggest not use them in leavening or freezing cells. Clean with an oiled soft cloth. Do not wash with water and caustic solutions.

Alusteel baking sheets

Alusteel baking sheets should better kept oiled but, thanks to the special aluminum coating they show a higher resistance against oxidation. Before use, put them at 150°C in the oven for half an hour, in order to eliminate the protective industrial oil. They can be used both in leavening and freezing cells. Clean with an oiled soft cloth. Do not wash with water and caustic solutions.

Aluminum baking sheets

Aluminum baking sheets do not need any special maintenance. Aluminum mechanical features can alter at a temperature above 300°C, which is usually not reached by common ovens. Clean with a moist soft cloth.

Non-stick baking sheets

Clean with air-jet or soft nylon brushes. Do not scratch the coating with metallic utensils or abrasive brushes, because scratches can lead to permeation and subsequently corrosion. Do not put empty sheets in the oven at 200°C or more. This is the border-line temperature for the resin thermal resistance. Moreover, at such a temperature the coating softens and this causes a faster decline of non sticking features. Do not wash the baking sheets with high pressure pulivapor (steamer) and avoid contact with caustic solutions. Always clean them with a moist soft cloth.

CESTI POLYRATTAN POLYRATTAN BREAD BASKETS



Cesto pane, PP
Bread basket
Brot-Korb
Corbeille à pain
Cesta pan

art.	dim. cm.	h.
42973-30	30x40	16/27



Cesto pane, PP
Bread basket
Brot-Korb
Corbeille à pain
Cesta pan

art.	dim. cm.	h.
42973-45	45x40	16/27



Cesto pane, PP
Bread basket
Brot-Korb
Corbeille à pain
Cesta pan

art.	dim. cm.	h.
42973-60	60x40	16/27



Divisorio, PP
Divider
Trenner
Séparateur
Divisor

art.	cm.	h.
42973-61	38	15/26



Cesto pane, PP
Bread basket
Brot-Korb
Corbeille à pain
Cesta pan

art.	dim. cm.	h.
42972-60	60x40	60



Cesto pane, PP
Bread basket
Brot-Korb
Corbeille à pain
Cesta pan

art.	dim. cm.	h.
42972-40	40x30	48



Cesto pane, PP
Bread basket
Brot-Korb
Corbeille à pain
Cesta pan

art.	dim. cm.	h.
42967-40	40x50	14/25



Cesta baguettes, PP
Bread basket
Brotkorb
Corbeille à pain
Cesta pan

art.	ø cm.	h.
42967-35	35	42



Cesta baguettes, PP
Bread basket
Brotkorb
Corbeille à pain
Cesta pan

art.	ø cm.	h.
42972-28	30	38



Cesta baguettes, PP
Bread basket
Brotkorb
Corbeille à pain
Cesta pan

art.	ø cm.	h.
42972-29	30	39



Cesto pane, PP
Bread basket
Brot-Korb
Corbeille à pain
Cesta pan

art.	ø cm.	h.
42968-38	38	10



Cesto pane, PP
Bread basket
Brot-Korb
Corbeille à pain
Cesta pan

art.	ø cm.	h.
42968-37	37	9



Cesto pane, PP
Bread basket
Brot-Korb
Corbeille à pain
Cesta pan

art.	ø cm.	h.
42968-42	42	12



Cesto pane, PP
Bread basket
Brot-Korb
Corbeille à pain
Cesta pan

art.	ø cm.	h.
42969-31	37	12



Cesto pane, PP
Bread basket
Brot-Korb
Corbeille à pain
Cesta pan

art.	ø cm.	h.
42969-36	36,5	12,0
42969-42	42,0	18,5
42969-46	46,0	18,5



Cesto pane, PP
Bread basket
Brot-Korb
Corbeille à pain
Cesta pan

art.	dim. cm.	h.
42967-43	41x40	25

Cesti buffet sistema GN, con telaio in filo inox per stabilizzare il cesto.
Buffet baskets GN system, with stainless steel wire frame to stabilize the basket.



Beige

Cesto pane, sistema GN
Bread basket, GN system
Brot-Korb, GN System
Corbeille à pain, système GN
Cesta pan, sistema GN

art.	dim. cm.	h.	GN
42967-03	53x32,5	6,5	1/1
42967-04	32,5x26,5	6,5	1/2
42967-05	32,5x17,5	6,5	1/3
42967-06	26,4x16,2	6,5	1/4
42967-07	17,6x16,2	6,5	1/6
42967-08	32,5x35,4	6,5	2/3

Cesto pane, sistema GN
Bread basket, GN system
Brot-Korb, GN System
Corbeille à pain, système GN
Cesta pan, sistema GN

art.	dim. cm.	h.	GN
42967-13	53x32,5	10	1/1
42967-14	32,5x26,5	10	1/2
42967-15	32,5x17,5	10	1/3
42967-16	26,4x16,2	10	1/4
42967-17	17,6x16,2	10	1/6
42967-18	32,5x35,4	10	2/3



Moro - Brown

Cesto pane, sistema GN
Bread basket, GN system
Brot-Korb, GN System
Corbeille à pain, système GN
Cesta pan, sistema GN

art.	dim. cm.	h.	GN
42967-63	53x32,5	6,5	1/1
42967-64	32,5x26,5	6,5	1/2
42967-65	32,5x17,5	6,5	1/3
42967-66	26,4x16,2	6,5	1/4
42967-67	17,6x16,2	6,5	1/6
42967-68	32,5x35,4	6,5	2/3

Cesto pane, sistema GN
Bread basket, GN system
Brot-Korb, GN System
Corbeille à pain, système GN
Cesta pan, sistema GN

art.	dim. cm.	h.	GN
42967-73	53x32,5	10	1/1
42967-74	32,5x26,5	10	1/2
42967-75	32,5x17,5	10	1/3
42967-76	26,4x16,2	10	1/4
42967-77	17,6x16,2	10	1/6
42967-78	32,5x35,4	10	2/3



41418-11



Cesto pane, PP
Bread basket
Brot-Korb
Corbeille à pain
Cesta pan

art.	dim. cm.	h.
42972-01	40x20	5
42972-02	40x30	5
42972-03	60x20	5
42972-04	60x40	5

Cesto pane, PP
Bread basket
Brot-Korb
Corbeille à pain
Cesta pan

art.	dim. cm.	h.
42967-53	53x32,5	15,5

Cesto pane, PP
Bread basket
Brot-Korb
Corbeille à pain
Cesta pan

art.	dim. cm.	h.
42968-26	26x26	20



Alzata, cromata
Buffet stand, chrome plated
Buffet-Gestell, Metall hartverchromt
Présentoir, chromé
Soporte, cromado

art.	dim. cm.	h.
42872-02	46x24	21

Per cesti Polyrattan 42965-12, 42967-04-14-64-74. - Made for Polyrattan baskets 42965-12, 42967-04-14-64-74.



Cesto pane, PP
Bread basket
Brot-Korb
Corbeille à pain
Cesta pan

art.	dim. cm.	h.
42946-23	23x10	6
42946-37	37,5x15	7



Cesto pane, PP
Bread basket
Brot-Korb
Corbeille à pain
Cesta pan

art.	dim. cm.	h.
42947-23	23x15	7
42947-30	30x22	7
42947-40	41x29	7



41415-11



Cesto pane, PP
Bread basket
Brot-Korb
Corbeille à pain
Cesta pan

art.	dim. cm.	h.	GN
42967-11	56,5x36	10	1/1

Con telaio per fissare il coperchio.
With frame to fix the cover.



Cesto pane, PP
Bread basket
Brot-Korb
Corbeille à pain
Cesta pan

art.	dim. cm.	h.	GN
42461-11	56,5x36	10	1/1

Con telaio per fissare il coperchio.
Fornito senza coperchio 42452-53.
With frame to fix the cover: Roll-top 42452-53 not included.



Cesto pane, PP
Bread basket
Brot-Korb
Corbeille à pain
Cesta pan

art.	ø cm.	h.
42461-35	35	20

Con telaio per fissare il coperchio.
Fornito senza coperchio 42452-35.
With frame to fix the cover: Roll-top 42452-35 not included.



Cesto pane, PP
Bread basket
Brot-Korb
Corbeille à pain
Cesta pan

art.	dim. cm.	h.
42936-23	23x19	9



Cesto pane, PP
Bread basket
Brot-Korb
Corbeille à pain
Cesta pan

art.	dim. cm.	h.
42936-24	24x17	8,0
42936-28	28x16	8,5



Supporto cromato, 2 piani
Frame, chrome plated, 2 tiers
Brotkorb-Gestell, Doppeldecker
Support chomé, 2 étages
Estructura cromada, 2 alturas

art.	dim. cm.	h.	GN
42965-AB	29x27	35,0	1/2
42965-AA	50x34	37,5	1/1



Cesto pane, PP
Bread basket
Brot-Korb
Corbeille à pain
Cesta pan

art.	dim. cm.	h.	GN
42965-12	32,5x26,5	8	1/2



Cesto pane, PP
Bread basket
Brot-Korb
Corbeille à pain
Cesta pan

art.	dim. cm.	h.	GN
42969-11	53,5x32,5	9,5	1/1

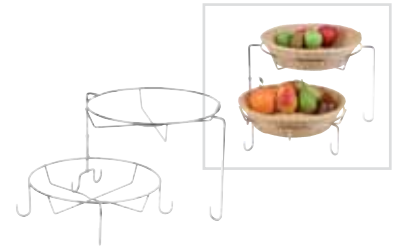

Alzata, cromata
Buffet stand, chrome plated
Buffet-Gestell, Metall hartverchromt
Présentoir, chromé
Soporte, cromado

art.	dim. cm.	ø	h.
42871-02	92x47	36	30

Per cesto Polyrattan 42968-38.
Made for Polyrattan basket 42968-38.

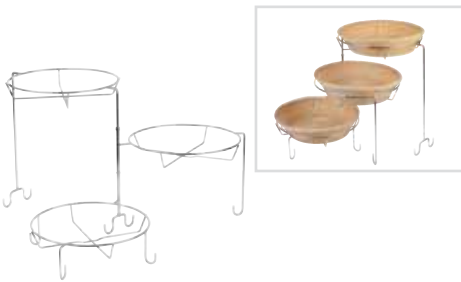

Alzata, cromata
Buffet stand, chrome plated
Buffet-Gestell, Metall hartverchromt
Présentoir, chromé
Soporte, cromado

art.	dim. cm.	ø	h.
42871-03	92x77	36	50

Per cesto Polyrattan 42968-38.
Made for Polyrattan basket 42968-38.



Alzata buffet, legno
Buffet stand, wood
Büffet-Gestell, Holz
Etagère à buffet, bois
Soporte buffet, madera

art.	dim. cm.
42870-59	59x30,5x2

Per cesto Polyrattan 42968-38 e 42967-13 GN 1/1. - Made for Polyrattan basket 42968-38 and 42967-13 GN 1/1.



Cesto uova, imbottito, RATTAN
Egg basket, keeps warm
Eier-Korb, hält warm
Panier à oeufs, fourré
Cesta para huevos

art.	ø cm.	h.
42949-26	26	17



Cesto pane, PP
Bread basket
Brot-Korb
Corbeille à pain
Cesta pan

art.	ø cm.	h.
42944-23	23	7



Cesto pane, PP
Bread basket
Brot-Korb
Corbeille à pain
Cesta pan

art.	dim. cm.	h.
42945-27	27x20	10



Cesto pane, PP
Bread basket
Brot-Korb
Corbeille à pain
Cesta pan

art.	dim. cm.	h.
42945-18	18x13	6,5
42945-23	23x15	6,5



Cesto pane, PP
Bread basket
Brot-Korb
Corbeille à pain
Cesta pan

art.	ø cm.	h.
42948-18	18	7
42948-20	20	7
42948-25	25	7



Cesto pane, PP
Bread basket
Brot-Korb
Corbeille à pain
Cesta pan

art.	dim. cm.	h.
42948-23	23x15	6,5



Cesto pane, PP
Bread basket
Brot-Korb
Corbeille à pain
Cesta pan

art.	ø cm.	h.
42935-19	19	9
42935-26	26	9

UTENSILI KITCHEN UTENSILS



Cesto pane, PP
Bread basket
Brot-Korb
Corbeille à pain
Cesta pan

art.	ø cm.	h.
42990-16	16	8
42990-20	20	8
42990-29	29	7



Cesto pane, PP
Bread basket
Brot-Korb
Corbeille à pain
Cesta pan

art.	ø cm.	h.
42990M16	16	8
42990M20	20	8
42990M29	29	7



Cesto pane, PP
Bread basket
Brot-Korb
Corbeille à pain
Cesta pan

art.	ø cm.	h.
42990N16	16	8
42990N20	20	8
42990N29	29	7



Cesto pane, PP
Bread basket
Brot-Korb
Corbeille à pain
Cesta pan

art.	dim. cm.	h.
42991-25	25x19	6,5
42991-32	32x23	7,0



Cesto pane, PP
Bread basket
Brot-Korb
Corbeille à pain
Cesta pan

art.	dim. cm.	h.
42991M25	25x19	6,5
42991M32	32x23	7,0



Cesto pane, PP
Bread basket
Brot-Korb
Corbeille à pain
Cesta pan

art.	dim. cm.	h.
42991N25	25x19	6,5
42991N32	32x23	7,0



Cesto pane, PP
Bread basket
Brot-Korb
Corbeille à pain
Cesta pan

art.	dim. cm.	h.
42992-28	28x16	8
42992-40	40x16	8



Cesto pane, PP
Bread basket
Brot-Korb
Corbeille à pain
Cesta pan

art.	dim. cm.	h.
42992M28	28x16	8
42992M40	40x16	8



Cesto pane, PP
Bread basket
Brot-Korb
Corbeille à pain
Cesta pan

art.	dim. cm.	h.
42992N28	28x16	8
42992N40	40x16	8



Cesto pane, PP
Bread basket
Brot-Korb
Corbeille à pain
Cesta pan

art.	dim. cm.	h.
42993-30	29,5x20,5	13



Cesto pane, PP
Bread basket
Brot-Korb
Corbeille à pain
Cesta pan

art.	dim. cm.	h.
42993M30	29,5x20,5	13



Cesto pane, PP
Bread basket
Brot-Korb
Corbeille à pain
Cesta pan

art.	dim. cm.	h.
42993N30	29,5x20,5	13



Cesto pane, PP
Bread basket
Brot-Korb
Corbeille à pain
Cesta pan

art.	dim. cm.	h.
42994-26	26,5X19	7
42994-31	31X21	9



Cesto pane, PP
Bread basket
Brot-Korb
Corbeille à pain
Cesta pan

art.	dim. cm.	h.
42994M26	26,5X19	7
42994M31	31X21	9



Cesto pane, PP
Bread basket
Brot-Korb
Corbeille à pain
Cesta pan

art.	dim. cm.	h.
42994N26	26,5X19	7
42994N31	31X21	9



Cesto pane, PP
Bread basket
Brot-Korb
Corbeille à pain
Cesta pan

art.	dim. cm.	h.
42993-40	40X30	10



Cesto pane, PP
Bread basket
Brot-Korb
Corbeille à pain
Cesta pan

art.	dim. cm.	h.
42993M40	40X30	10



Cesto pane, PP
Bread basket
Brot-Korb
Corbeille à pain
Cesta pan

art.	dim. cm.	h.
42993N40	40X30	10



Cesto cotone, rotondo
Round canvas bag
Brottasche, rund, Baumwolle
Panier à pain rond, coton
Cesta pan redonda, algodón

art.	ø cm.	h.
42875-17	17	8
42875-20	20	9



Cesto cotone, rotondo
Round canvas bag
Brottasche, rund, Baumwolle
Panier à pain rond, coton
Cesta pan redonda, algodón

art.	ø cm.	h.
42875B17	17	8
42875B20	20	9



Cesto cotone, ovale
Oval canvas bag
Brottasche, oval, Baumwolle
Panier à pain ovale, coton
Cesta pan , algodón

art.	dim. cm.	h.
42876-20	20x15	7
42876-25	25x18	9

Cotone, lavabile a macchina fino a 40° C. - Cotton, machine-washable up to 40° C.



Cesto cotone, ovale
Oval canvas bag
Brottasche, oval, Baumwolle
Panier à pain ovale, coton
Cesta pan , algodón

art.	dim. cm.	h.
42876B20	20x15	7
42876B25	25x18	9



Cesto cotone, rotondo
Round canvas bag
Brottasche inklusive Kirschkernkissen, Baumwolle
Panier à pain, coton
Cesta pan, algodón

art.	ø cm.	h.
42873-01	20	23,5



Cesto cotone, ovale
Oval canvas bag
Brottasche, oval, Baumwolle
Panier à pain ovale, coton
Cesta pan , algodón

art.	ø cm.	h.
42873-02	20	23,5



Cuscino in noccioli di ciliegio incluso. Scaldare in microonde per 30 secondi a 300 Watt. - Cherry stone pillow included. Easy to heat up in microwave for 30 sec. at 300 Watt.



Cesta pane, faggio
Beech wood bread box
Holzkiste, Buche
Panier à pain, hêtre
Cesta pan, madera

Tagliere, faggio
Beech wood bread cutting board
Brotschneidbrett, Buche
Planche à découper, hêtre
Tabla de corte, madera

Vassoio, melamina
Melamine tray
Tablett, Melamin
Plateau, melamine
Bandeja, melamine

art.	dim. cm.	h.
42874-01	34x26	12,5
42874-02	34x26	20,0

art.	dim. cm.	h.
42874-03	52x34	2

art.	dim. cm.	h.
42874-04	60x35,5	3,5



10 clip porta etichette flex , PC
10 sign holders, flex
10 Schilderhalter, Flex-Clip
10 porte-étiquettes, flex
10 clips, flex



10 clip porta etichette, PP
10 sign holders
10 Beschriftungsclips
10 porte-étiquettes
10 clips



2 clip flessibili, cromate
2 sign holders, chromed
2 Schilderhalter, verchromt
2 porte-étiquettes, chromés
2 clips, metal cromado



art.	l. cm.	col.
41392-10	9,5	○
41392B10	9,5	●

art.	dim. cm.	col.
41393-10	6x2,7	○
41393B10	6x2,7	●

art.	h.
41394-02	12



COLTELLERIA
KNIVES
KOCHMESSER
COUPELLERIE
CUCHILLERIA

P SERIE 18100

COLTELLI FORGIATI
FORGED KNIVES



Uno studio approfondito e prove computerizzate di ergonomia, movimento e postura hanno permesso a Paderno di creare una linea di coltelli professionali, sintesi perfetta tra comfort e perfezione del taglio. Manico realizzato in speciale materiale plastico sviluppato per il settore alimentare, design ergonomico con bordi arrotondati, presa perfetta per garantire un taglio di precisione. Lama forgiata realizzata in lega di speciale acciaio, molibdeno e vanadio con particolare processo di tempra che garantisce al prodotto un ottimo taglio ed una perfetta e lunga tenuta di filo.

A deep study and computerised tests of ergonomics, movement and posture have allowed Paderno to create a professional knives line, that is the synthesis of comfort and cutting precision. Handle made of plastic specially developed for the food processing sector, ergonomic design with soft edges, perfect grip to ensure precise guidance. The forged blade realised in special steel and molybdenum/vanadium, thanks to a peculiar hardening process, guarantees to the product a perfect cut and a long life of the blade's edge.



Cottello cucina
Cook's knife
Kochmesser
Couteau cuisine
Cuchillo de cocinero

art.	dim. cm.
18100-16	16
18100-20	20
18100-24	24
18100-30	30
18100-36	36



Cottello francese
Butcher's knife
Kochmesser
Couteau de chef
Cuchillo de carnicero

art.	dim. cm.
18102-16	16
18102-20	20
18102-26	26
18102-30	30



Cottello cucina orientale
Oriental cook's knife
Japanisches Kochmesser
Couteau de chef style japonais
Cuchillo cocinero japoné

art.	dim. cm.
18103-18	18



Cottello cucina orientale, alveolato
Oriental cook's knife, dimpled ground
Japanisches Kochmesser mit Kullenschliff
Couteau de chef style japonais alveolé
Cuchillo cocinero japonés, con alvéolos

art.	dim. cm.
18104-18	18



Cottello affettare
Slicer
Fleischmesser
Tranchelard
Cuchillo para filetear

art.	dim. cm.
18106-15	15
18106-20	20
18106-25	25
18106-30	30



Cottello prosciutto
Ham knife
Schinkenmesser
Trancheur à rôti
Cuchillo para jamón

art.	dim. cm.
18109-26	26
18109-30	30
18109-36	36



Cottello prosciutto, alveolato
Ham knife, dimpled ground
Schinkenmesser mit Kullenschliff
Couteau à rôti alvéolé
Cuchillo para jamón, con alvéolos

art.	dim. cm.
18110-26	26
18110-30	30
18110-36	36



Cottello salmone
Salmon knife
Lachsmesser
Couteau à saumon
Cuchillo para salmón

art.	dim. cm.
18111-30	30



Cottello salmone, alveolato
Salmon knife, dimpled ground
Lachsmesser mit Kullenschliff
Couteau à saumon alvéolé
Cuchillo para salmón, con alvéolos

art.	dim. cm.
18112-30	30



Cottello trinciante
Carving knife
Filiermesser
Couteau à découper
Cuchillo para trinchar

art.	dim. cm.
18114-20	20

COLTELLERIA KNIVES



Coltello filettare, flessibile
 Filletting, flexible
 Filiermesser, flexibel
 Filet de sole, flexible
 Cuchillo para filetear, flexible

art.	dim. cm.
18115-20	20
18115-25	25



Coltello disosso
 Boning knife
 Ausbeinmesser
 Couteau à désosser
 Cuchillo para deshuesar

art.	dim. cm.
18116-14	14
18116-18	18



Coltello bistecca
 Steak knife
 Steakmesser
 Couteau à steak
 Cuchillo para steak

art.	dim. cm.
18122-12	12



Spelucchino
 Paring knife
 Spickmesser
 Couteau d'office
 Cuchillo mondador

art.	dim. cm.
18124-09	9



Spelucchino
 Paring knife
 Spickmesser
 Couteau d'office
 Cuchillo mondador

art.	dim. cm.
18125-07	7
18125-10	10



Coltello cuoco
 Bent paring knife
 Tourniermesser
 Bec d'oiseau
 Cuchillo verdura

art.	dim. cm.
18126-07	7



Coltello tavola
 Table knife
 Allzweckmesser
 Couteau bout rond cranté
 Cuchillo para mesa

art.	dim. cm.
18123-11	11



Coltello pane
 Bread knife
 Brotmesser mit Wellenschliff
 Couteau à pain ondulé
 Cuchillo para pan

art.	dim. cm.
18128-20	20
18128-24	24
18128-30	30



Forchettone
 Meat fork
 Fleischgabel
 Fourchette diapason
 Tenedor para carne

art.	dim. cm.
18230-13	13
18230-17	17



Forchettone curvo
 Carving fork curved
 Fleischgabel
 Fourchette à viande
 Tenedor curvo para carne

art.	dim. cm.
18231-13	13

SERIE 18000 P

COLTELLI SERIE TRANCIATA
SHEAR KNIVES



La linea di coltelleria professionale "CCS" – Color Coding System riduce i rischi di contaminazione incrociata grazie all'utilizzo di un Sistema di Codifica dei Colori che identifica ogni coltello per un uso specifico e permette di individuare facilmente le diverse aree di lavoro. Gli acciai utilizzati per questa linea di coltelleria presentano un'eccezionale durezza ed elevata resistenza alla corrosione, grazie all'uso del sistema ICE-HARDENING, processo speciale per temprare l'acciaio. Per ogni articolo sono riportati i colori del manico in cui si rende disponibile, nonché le dimensioni delle rispettive lame. Il codice indicato nelle tabelle (es. 18000-16) si riferisce al manico in colore nero. Il codice del manico colorato si ottiene sostituendo il trattino con la lettera corrispondente al colore, da ricercarsi nella legenda. Se ad esempio si vuole ordinare un coltello con il manico rosso, la lettera corrispondente è la "R" e il codice di riferimento il 18000R16.

The professional cutlery line "Color-Line" helps to reduce the risk of cross contamination using a Color Coding System which identifies each knife with a specific task: different food processing areas are easily identified. The steel used for this cutlery line has exceptional hardness and very high resistance to corrosion due to ICE-HARDENED system, a special process to harden the steel.

The colors of the handle for each article are indicated, as well as the dimensions of the respective blades.

The reference in the descriptions (ex. 18000-16) refers to the handle in black color.

The code of the colored handle is given by replacing the hyphen with the corresponding letter of the color, please see the key.

For instance if you would like to order a knife with the red handle, the corresponding letter is "R" and the reference is 18000R16.

COLTELLERIA KNIVES



R = ROSSO / RED
Carni crude
Raw meat

M = MARRONE / BROWN
Verdure
Vegetables

B = BLU / BLUE
Pesce
Raw fish

Y = GIALLO / YELLOW
Carni cotte, polleria
Cooked meat, poultry

G = VERDE / GREEN
Insalate, frutta
Salad, fruit

W = BIANCO / WHITE
Latticini, pane
Dairy products, bakery



Coltello cucina
Cook's knife
Kochmesser
Couteau cuisine
Cuchillo de cocinero

art.	dim. cm.	colori disponibili / colors available
18000-16	16	●●●●●●●●
18000-20	20	●○●●●●●●
18000-23	23	●●●●●●●●
18000-26	26	●○●●●●●●
18000-30	30	●○●●●●●●
18000-36	36	●



Coltello scimitarra
Butcher's knife
Blockmesser
Couteau à découper
Cuchillo de carnicero

art.	dim. cm.	colori disponibili / colors available
18005-22	22	●●●●●●
18005-27	27	●●●●●●
18005-32	32	●●●●●●



Coltello francese
Butcher's knife
Schlachtsmesser
Couteau à découper
Cuchillo carnicero francés

art.	dim. cm.	colori disponibili / colors available
18002-18	18	●●●●
18002-20	20	●●●●
18002-22	22	●●●●
18002-26	26	●●●●●●
18002-30	30	●●●●●●
18002-36	36	●●●●



Coltello affettare
Slicer knife
Wurstmesser
Couteau à jambon
Cuchillo para filetear

art.	dim. cm.	colori disponibili / colors available
18006-20	20	●●●●●●
18006-25	25	●●●●●●
18006-30	30	●●●●●●
18006-36	36	●



Coltello affettare, dentato
Slicer knife, wavy blade
Wurstmesser mit Wellenschliff
Couteau à jambon ondulé
Cuchillo para filetear, dentado

art.	dim. cm.	colori disponibili / colors available
18007-25	25	●
18007-30	30	●●
18007-36	36	●



Coltello cucina
Cook's knife
Kochmesser
Couteau cuisine
Cuchillo cocina

art.	dim. cm.	colori disponibili / colors available
18008-20	20	●
18008-26	26	●●
18008-30	30	●●●●●●
18008-36	36	●●



Cottello prosciutto
Ham knife
Schinkenmesser
Trancheur à rôti
Cuchillo para jamón

art.	dim. cm.	colori disponibili / colors available
18009-25	25	●○●●●●●●
18009-30	30	●○●●●●●
18009-36	36	●



Cottello salmone
Salmon knife
Lachsmesser
Couteau à saumon
Cuchillo salmón

art.	dim. cm.	colori disponibili / colors available
18011-32	32	●



Cottello prosciutto, alveolato
Ham knife, dimpled ground
Schinkenmesser mit Kullenschliff
Couteau à rôti alvéolé
Cuchillo jamón con alvéolos

art.	dim. cm.	colori disponibili / colors available
18010-25	25	●
18010-30	30	●●
18010-36	36	●



Cottello salmone, alveolato
Salmon knife, dimpled ground
Lachsmesser mit Kullenschliff
Couteau à saumon alvéolé
Cuchillo salmón con alvéolos

art.	dim. cm.	colori disponibili / colors available
18012-32	32	●●



Cottello salati/Formaggio
Cheese slicer
Universalmesser
Couteau universel
Cuchillo universal/quesos

art.	dim. cm.	colori disponibili / colors available
18013-30	30	●○
18013-36	36	●○



Cottello per filettare
Filleting knife
Filiermesser
Filet de sole
Cuchillo para filetear

art.	dim. cm.	colori disponibili / colors available
18015-18	18	●●●●●
18015-22	22	●●●●
18015-27	27	●●



Cottello disosso
Boning knife
Ausbeinmesser
Couteau à désosser
Cuchillo para deshuesar

art.	dim. cm.	colori disponibili / colors available
18016-14	14	●●●●
18016-16	16	●○●●●●



Cottello disosso emilia
Boning knife
Ausbeinmesser
Couteau à désosser
Cuchillo para deshuesar

art.	dim. cm.	colori disponibili / colors available
18017-14	14	●
18017-16	16	●●●●
18017-18	18	●



Cottello scannapolli
Poultry sticking knife
Geflügelschlachtmesser
Couteau à volaille
Cuchillo para deshuesar

art.	dim. cm.	colori disponibili / colors available
18018-11	11	●●●



Cottello scannare
Sticking knife
Stechmesser
Couteau à saigner
Cuchillo para destrozor

art.	dim. cm.	colori disponibili / colors available
18019-12	12	●●
18019-14	14	●
18019-16	16	●●
18019-18	18	●●
18019-20	20	●●

COLTELLERIA KNIVES



Coltello surgelati a doppia lama seghettata
Frozen food, two serrated edges
Tiefkühltruhenmesser, Gezahnter Schliff
Couteau dentelé pour produits surgelés
Cuchillo para congelados, hoja doble, dentada

art.	dim. cm.	colori disponibili / colors available
18020-23	23	●●●●



Coltello surgelati lama seghettata speciale
Frozen food special serrated blade
Tiefkühltruhenmesser, Gezahnter Schliff
Couteau dentelé pour produits surgelés
Cuchillo para congelados, dentado especial

art.	dim. cm.	colori disponibili / colors available
18021-18	18	●●●●



Coltello bistecca
Steak knife
Steakmesser
Couteau à steak
Cuchillo para steak

art.	dim. cm.	colori disponibili / colors available
18022-12	12	●



Coltello tavola, mezzo dentato
Table knife, half-waved
Allzweckmesser
Couteau universel
Cuchillo mesa, medio dentado

art.	dim. cm.	colori disponibili / colors available
18023-11	11	●



Spelucchino
Paring knife
Spickmesser
Couteau d'office
Cuchillo mondador

art.	dim. cm.	colori disponibili / colors available
18024-08	8	●○●●●●●●
18024-11	11	●○●●●●●●



Spelucchino
Bent paring knife
Tourniermesser
Bec d'oiseau
Cuchillo verdura

art.	dim. cm.	colori disponibili / colors available
18026-07	7	●●●●●



Coltello pasticceria
Baker's knife
Bächrmesser
Couteau de pâtissier
Cuchillo para pastelería

art.	dim. cm.	colori disponibili / colors available
18029-30	30	●○
18029-36	36	●○ seghettato - wavy



Coltello pane
Bread knife
Brotmesser
Couteau à pain
Cuchillo para pan

art.	dim. cm.	colori disponibili / colors available
18028-21	21	●○



Coltello pane
Bread knife
Brotmesser
Couteau à pain
Cuchillo para pan

art.	dim. cm.	colori disponibili / colors available
18028-25	25	●○●●
18028-30	30	●○●●●
18028-36	36	●○



Coltello dolce
Cake knife
Bächrmesser
Couteau de pâtissier
Cuchillo para pastelería

art.	dim. cm.	colori disponibili / colors available
18030-26	26	●○
18030-31	31	●○
18030-36	36	●○

PEZZI SPECIALI P

SPECIAL ITEMS



Coltello universale, seghettato
 Universal knife, wavy edge
 Universalmesser mit Wellenschliff
 Couteau universel, lame dentelée
 Cuchillo universal serrado

art.	dim. cm.	colori disponibili / colors available
18029-25	25	●○



Falcetta cinese
 Slicer, chinese style
 Kochmesser, chinesische Form
 Couteau de cuisine, style chinois
 Cuchillo cocina, estilo chino

art.	dim. cm.	colori disponibili / colors available
18221-17	17	●●●●●●●●
18221-19	19	●●●●●●●●
18221-21	21	●●●●●●●●



Falcetta macellaio
 Meat cleaver
 Hackmesser
 Couperet
 Hacha de carnicero

art.	dim. cm.	Kg.	colori disponibili / colors available
18220-18	18	0,55	●●●●



Falcetta macellaio
 Meat cleaver
 Hackmesser
 Couperet
 Hacha de carnicero

art.	dim. cm.	Kg.	colori disponibili / colors available
18220-20	20	1,1	●●●●
18220-22	22	1,3	●●●●



Falcetta macellaio
 Meat cleaver
 Hackmesser
 Couperet
 Hacha de carnicero

art.	dim. cm.	Kg.	colori disponibili / colors available
18220-26	26	1,3	●●●●



Mezzo colpo
 Bone splitter
 Kochschlagmesser
 Couteau de cuisine lourd
 Cuchillo cocina pesado

art.	dim. cm.	Kg.	colori disponibili / colors available
18224-28	28	0,75	●●●●



Colpo
Bone splitter
Kochschlagmesser
Couteau de cuisine lourd
Cuchillo cocina pesado

art.	dim. cm.	Kg.	colori disponibili / colors available
18225-28	28	1	●●



Grana
Parmesan knife
Parmesanmesser
Couteau à Parmesan
Cuchillo para queso

art.	dim. cm.
18205-10	10



Grana
Parmesan knife
Parmesanmesser
Couteau à Parmesan
Cuchillo para queso

art.	dim. cm.
18205-12	12



Coltello segnaforme
Cheese knife
Käsemesser
Couteau à fromage
Cuchillo para queso

art.	dim. cm.
18206-09	9



Coltello lancia "Milano"
Cheese knife
Käsemesser
Couteau à fromage
Cuchillo para queso

art.	dim. cm.
18207-15	15



Coltello apriostriche
Oyster knife
Austernmesser
Couteau à huîtres
Cuchillo ostras

art.	dim. cm.
18209-06	15



Coltello formaggio
Cheese knife
Käsemesser
Couteau à fromage
Cuchillo queso

art.	dim. cm.
18201-36	36



Coltello verdure
Vegetables knife
Gemusemesser
Couteau à crudités
Cuchillo verduras

art.	dim. cm.
18222-18	18

Santoku è un coltello di origine giapponese tra il trinciante (coltello da cuoco) ed il coltello da verdure. La parola Santoku significa "tre virtù", infatti si adatta benissimo a tre tipi di alimenti da tagliare: carne, pesce e verdure, questa caratteristica lo rende in assoluto il coltello più universale in cucina. Le speciali scanalature e la dentellatura sottile sul retro della lama conferiscono al coltello una perfetta e più lunga tenuta di filo ed un'ottima ventilazione durante il taglio. La lama può essere riaffilata normalmente mantenendo le caratteristiche conferite dalle scanalature.

The Santoku knife is a general-purpose kitchen knife originating in Japan. The word santoku loosely translates as 'three virtues' or 'three uses', a reference to the three cutting tasks the knife performs well: slicing, dicing, and mincing. The special grooves and slim serration on the back side of blade make this knife very sharp and easy to cut and allow good ventilation while slicing (non-stick). The knife can be sharpened on both sides, retaining serration and more efficient long lasting sharpness.



Cannula disosso prosciutti
Ham boner
Schinkenauslöser
Gouge à jambons
Cuchillo deshuesar jamón

art.	dim. cm.
48021-21	21



Cottello formaggio
Cheese knife
Käsemesser
Couteau à fromage
Cuchillo para queso

art.	dim. cm.
18203-26	26



Cottello gastronomia
Baking pan knife
Winkelmesser
Couteau à gastronomie
Cuchillo gastronomia

art.	dim. cm.
18215-13	13,5



Cottello gastronomia
Baking pan knife
Winkelmesser
Couteau à gastronomie
Cuchillo gastronomia

art.	dim. cm.
18215-21	21,5



Cottello lasagne
Lasagne knife
Lasagnemesser
Couteau à lasagne
Cuchillo para lasagna

art.	dim. cm.
18216-22	22



Cottello torta
Pie knife
Tortmesser
Couteau à gâteau
Cuchillo para tartas

art.	dim. cm.
18514-18	18



Mezzaluna
Mincing knife
Wiegemesser
Hachoir
Media luna

art.	dim. cm.
48017-14	14
48017-25	26



Mezzaluna, lama doppia
Double blade mincing knife
Wiegemesser, Doppel-Klinge
Hachoir double lame
Media luna, doble

art.	dim. cm.
48215-14	14
48215-30	30



Cottello bistecca, manico PP
Steak knife, PP handle
Steakmesser, PP-Heft
Couteau à steak, manche PP
Cuchillo para steak, mango PP

art.	dim. cm.	u. pack
18217-12	12	6



Cottello bistecca/pizza
Steak/pizza knife
Steak-/Pizzamesser
Couteau à steak/pizza
Cuchillo para steak/pizza

art.	dim. cm.	u. pack
18218-12	12	6



Forchettone
Meat fork
Fleischgabel
Fourchette diapason
Tenedor para carne

art. dim. cm. colori disponibili / colors available
18226-17 17 ● ○ ● ● ● ● ● ●



Acciaio
Sharpening steel
Wetzstahl
Fusil à affûter
Afilador



art. dim. cm. colori disponibili / colors available
18235-26 26 ●
18235-30 30 ● ○ ● ● ● ● ● ●



Acciaio ovale
Oval sharpening steel
Wetzstahl, oval
Fusil à affûter, ovale
Afilador ovalado

art. dim. cm.
18236-30 30



Acciaio diamantato
Diamond sharpening steel
Diamant-Wetzstahl
Fusil à affûter, diamant
Afilador adiamantado

art. dim. cm.
18237-26 26



Pietra per affilare
Sharpening stone
Abziehstein
Pierre à aiguiser
Piedra para afilar

art. dim. cm. h. grit
18251-01 21x7 3 1000/240



Pietra per affilare
Sharpening stone
Abziehstein
Pierre à aiguiser
Piedra para afilar

art. dim. cm. h. grit
18251-02 21x7 3 1000/600

AFFILATURA

Acciaio e pietra per affilare, due utensili indispensabili per la buona manutenzione dei coltelli. Per ottenere una corretta affilatura, occorre mantenere un angolo costante di 15-20 gradi tra la lama e il mezzo affilante durante l'operazione.

ACCIAINO

L'acciaio serve a correggere e mantenere l'affilatura dei coltelli. Esso riallinea le molecole che compongono il bordo tagliente, che sono state spostate dagli urti continui, "ripristinando" l'affilatura. L'acciaio tradizionale è di forma tonda, molti chefs usano però un acciaio ovale in quanto la forma più larga permette un movimento di affilatura più ampio ed efficiente. L'acciaio diamantato è invece particolarmente efficace per riaffilare coltelli a lama liscia e può ripristinare un filo di un buon coltello con 6 fino a max 10 movimenti.

SHARPENING

Sharpening steel and stone, two indispensable utensils for the knives' good maintenance. To operate a correct sharpening a constant angle of 15°-20° must be kept between the blade and the sharpening utensils during the operation.

SHARPENING STEEL

The sharpening steel is useful to correct and maintain the knives sharpening. It readjusts the molecules that are the basis of the cutting edge, that have been shifted by the usage. The traditional sharpening steel is round shaped, lots of chefs use anyway an oval shaped one, because the larger shape enables a wider and more efficient sharpening movement. The diamond sharpening steel is particularly indicated for knives with flat blade and can renew a good knife's edge with just 6 to a maximum of 10 movements.

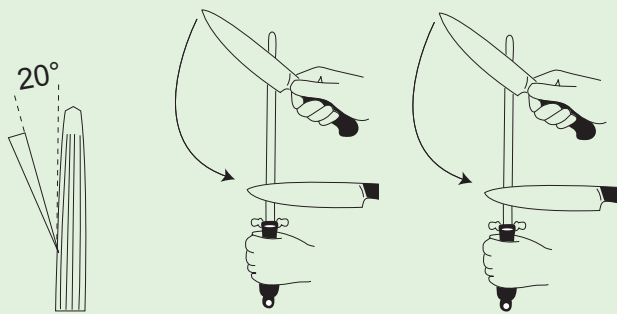

PIETRA ABRASIVA

L'affilatura vera e propria si esegue con la pietra abrasiva, composta di solito da ossido di alluminio o da carburo di silicio e deve necessariamente essere immersa in acqua prima dell'utilizzo, per garantire la sua lubrificazione durante l'uso. Esistono differenti tipi di pietra, identificate da livelli di grana diversi (grossa, media, fine), da utilizzare in relazione allo stato della lama: una pietra con grana fine (1000 grit) si utilizzerà per perfezionare l'affilatura, la grana grossa (300 grit) per un coltello che abbia perduto completamente il filo.

Procedimento di affilatura

Posizionare la pietra abrasiva con il suo supporto in gomma antiscivolo sul piano di appoggio.

Scegliere l'angolo di affilatura (per i coltelli da cucina di uso comune 15°-20°).

Applicare un movimento continuo, circolare o alternato alla lama sulla pietra, facendo attenzione a mantenere costante l'angolo di affilatura e a mantenere la lama sempre a contatto con la superficie della pietra.

VALORI DI INCLINAZIONE INCLINATION VALUE

Larghezza lama (l) Width (l)	Altezza inclinazione (h) Height of inclination (h)
2 cm	6 mm
4 cm	12 mm
6 cm	18 mm
8 cm	24 mm
10 cm	30 mm
12 cm	26 mm

ABRASIVE STONE

The true sharpening is done using the abrasive stone, usually composed by aluminum oxide or by silicone carbide and must absolutely be rinsed in water before usage in order to guarantee its lubrication during work. There are several types of stone, identified by different grains (coarse, medium, fine) that have to be used according to the blade condition: a stone with fine grain (1000 grit) will be used to improve the sharpening, a coarse grain (300 grit) for a knife that has completely lost the cutting edge.

Sharpening procedure

Placing the abrasive stone with its no-sliding rubber support on the standing surface.

Choose the sharpening angle (for commonly used kitchen knives 15°-20°).

Move the stone on the blade with a continuous, circular or alternate movement, carefully maintaining the same sharpening angle and always keeping the blade in touch with the stone surface.



Forbice per erbe, 5 lame
Herb scissors
Kräuterschere
Ciseaux à herbes
Tijeras hierbas

art.	dim. cm.
18277-00	10



Forbice da cucina, smontabile
Divisible kitchen scissors
Küchenschere, teilbar
Ciseaux cuisine, divisible
Tijeras de cocina, desmontables

art.	dim. cm.
18271-00	22,6



Forbice multiuso
Kitchen scissors
Küchenschere
Ciseaux cuisine
Tijeras de cocina, multiuso

art.	dim. cm.
18272-00	18,5



Forbice da cucina, smontabile
Divisible kitchen scissors
Universal-Küchenschere, teilbar
Ciseaux cuisine, divisible
Tijeras de cocina, desmontables

art.	dim. cm.
18273-00	18



Forbice da cucina, smontabile
Divisible kitchen scissors
Küchenschere, teilbar
Ciseaux cuisine, divisible
Tijeras de cocina, desmontables

art.	dim. cm.
18274-00	20



Forbice pizza, smontabile
Divisible pizza scissors
Pizzaschere, teilbar
Ciseaux pizza, divisible
Tijeras para pizza, desmontables

art.	dim. cm.
18276-00	25



Trinciapollo, smontabile
Divisible poultry shears
Geflügelschere, teilbar
Coupe volailles, divisible
Tijeras para aves, desmontables

art.	dim. cm.
18261-00	24



Trinciapollo
Poultry shears
Geflügelschere
Coupe volailles
Tijeras para ave

art.	dim. cm.
18263-00	25



Forbice pollame, smontabile
Poultry scissors, divisible
Geflügelschere, teilbar
Ciseaux à volaille, divisible
Tijeras para aves, desmontables

art.	dim. cm.
18275-00	26,5



Valigia cuoco, 15 pz.
Chef's set, 15 pieces
Kochkoffer, 15 Stk.
Mallette de chef, 15 pièces
Maleta del Chef, 15 piezas

Valigia cuoco, 19 pz.
Chef's set, 19 pcs
Kochkoffer, 19 Stk.,
Mallette de chef, 19 pcs
Maleta del Chef, 19 piezas

18099-15:	comprendente/includes	dim. cm.
18000-26	cucina / cook's knife	26
18000-30	cucina / cook's knife	30
18002-18	francese / butcher's knife	18
18002-26	francese / butcher's knife	26
18009-30	prosciutto / ham knife	30
18016-16	disosso / boning knife	6
18024-11	spelucchino / paring knife	11
18026-07	spelucchino / paring knife	7
18028-30	pane / bread knife	30
18230-17	forchettone / chef's fork	17
18235-30	acciaino / sharpener	30
18519-26	spatola cuoco / cook's spatula	26
48280-28	scavino doppio / melon baller	mm 22-28
48280-34	pelapatate / potato peeler	
18276-00	forbice pizza / pizza scissors	

18199-19:	comprendente/includes	dim. cm.
18100-24	cucina / cook's knife	24
18100-30	cucina / cook's knife	30
18112-30	salmone alveolato / salmon knife	30
18115-20	filettare / filleting knife	20
18116-14	disosso / boning knife	14
18125-10	spelucchino / paring knife	10
18126-07	spelucchino / bent paring knife	7
18128-30	pane / bread knife	30
18230-17	forchettone / chef's fork	17
18235-30	acciaino / sharpener	30
48280-28	scavino doppio / melon baller, double	mm 22-28
18276-00	forbice pizza / pizza scissors	
18255-00	affila coltelli / knife sharpener	
48280-25	levatorsoli / apple corer	
48280-44	coltello decorare / decorating knife	
48280-34	pelapatate / potato peeler	
48280-02	apribottiglie / can opener	
48280-27	scavino ovale / oval melon baller	
48280-92	decora limoni / lemon striper	



Rotolo portacoltelli, 9 pz. forgiati
Knife roll-bag, 9 pieces forged
Rolltasche, 9-teilig
Rouleau à couteaux, 9 pièces
Bolsa porta cuchillos, 9 piezas
art.

18190-09

Comprendente/Includes:
cucina/cook's knife cm 24 - affettare/slicer cm 25 -
prosciutto/ham knife cm 26 - disosso/boning knife
cm 14 - spelucchino/paring knife cm 9 - pane/
bread knife cm 24 - forchettone/chef's fork -
acciaino/sharpener - forbice cucina/kitchen
scissors.



Barra magnetica
Magnetic knife rack
Magnet-Messerhalter
Porte-couteaux magnetic
Barra magnética portas cuchillos

art.	l. cm.
48032-30	30
48032-45	45
48032-60	60



Ceppo porta coltelli, inox
Knife block, stainless steel
Messerblock, Edelstahl Rostfrei
Bloc à couteaux, inox
Bloc porta cuchillos, inox

art.	dim. cm.	h. cm.
49875-06	26x14	33



Ceppo porta coltelli legno, set 9 pz
Wood knife block, 9 pcs set
Holz-Messerblock, 9-tlg.
Bloc à couteaux en bois, set 9 pièces
Bloc porta cuchillos de madera, 9 piezas

art.
18192-09

Comprendente/Includes:
18100-20 cucina/cook's knife cm 20
18106-20 affettare/slicer cm 20
18124-09 spelucchino/paring knife cm 9
18128-20 pane/ bread knife cm 20
18230-17 forchettone/chef's fork cm 17
18235-26 acciaino/sharpener cm 26
18271-00 forbice cucina/kitchen scissors
18102-16 francese/butcher's knife cm 16
18126-07 cuoco/paring knife cm 7.



Ceppo porta coltelli, silicone
Knife block, silicone
Messerblock, Silikon
Bloc à couteaux, silicone
Bloc porta cuchillos, silicona

art.	ø cm.	h.
18191-22	10,5	22,5

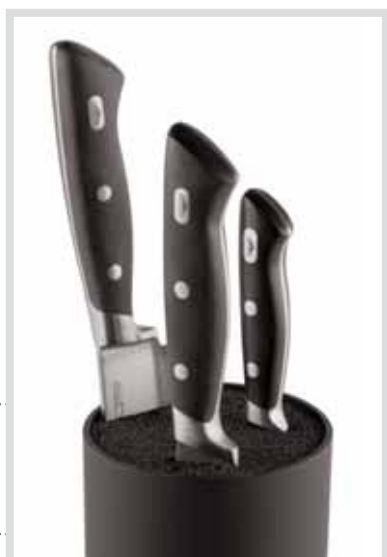

Ideale per ogni tipo di coltello, l'inserto removibile e facile da lavare è formato da astine flessibili che tengono i coltelli in posizione. Coltelli non inclusi. - To store any type of knives, the flexible rods hold knives in place anywhere in the block and can be removed for easy washing. Knives not included.



48040-AA



Porta coltelli, inox
Knife rack, stainless steel
Messeraufhänger, Edelstahl Rostfrei
Support à couteaux, inox
Porta cuchillos, inox

art.	dim. cm.	h.
48040-00	30,5x6,6	30,5
48040-AA	30,5x6,6	



Porta coltelli, inox
Knife rack, stainless steel
Messeraufhänger, Edelstahl Rostfrei
Support à couteaux, inox
Porta cuchillos, inox

art.	dim. cm.	h.
48040-10	30,5x6,6	35,6
48040-AA	30,5x6,6	



Porta coltelli, inox
Knife rack, stainless steel
Messeraufhänger, Edelstahl Rostfrei
Support à couteaux, inox
Porta cuchillos, inox

art.	dim. cm.	h.
48039-06	15,2x6,6	30,5



Affilacoltelli elettrico, inox
Electric knife sharpener, stainless steel
Elektro-Messerschleifapparat, Edelstahl Rostfrei
Aiguseur électrique, inox
Afilador eléctrico, inox

art.	dim. cm.	h.	kg.
49872-00	25x10	12	4

230V-172W, Rpm 1550 - Guida in ABS estraibile. Motore con dispositivo auto-bloccante. - ABS knife guide. Pressure sensitive motor shuts down automatically.



Affilacoltelli elettrico
Electric knife sharpener
Elektro-Messerschleifapparat
Aiguseur électrique
Afilador eléctrico

art.	dim. cm.	h.	kg.	V
49741-07	23x16	16	4,6	220/240
49741-15	23x33	16	6,4	220/240



Affilacoltelli manuale
Manual sharpener
Messer Schleifapparat
Affûteur manuel
Afilador manual

art.
49739-00

Il serbatoio permette la sterilizzazione ad immersione dell'intera lama. Fissaggio al muro stabile e sicuro. Inserti e serbatoio estraibili per una facile pulizia. - The liquid sanitizing tank allows for submersion of the entire blade. Secure wall mounting. Removable inserts and tank for easy cleaning.



P

Affilacoltelli manuale
Manual sharpener
Messer Schleifapparat
Affûteur manuel
Afilador manual

art.
18255-00



Pulisci coltelli
Knife cleaner
Messerabstreifbehälter
Nettoyeur à couteaux
Limpiador de cuchillos

art.	ø cm.	h.
48038-10	13	18



Sterilizzatore ad immersione
Knife sanitizing system
Messerentkeimer
Stérilisateur à couteaux
Esterilizador a inmersión

Etlund

art.	dim. cm.	h.
48040-50	45,7x11,5	45,7



Sterilizzatore 20 coltelli ad 1 porta, inox
Knife sterilizer for 20 pcs, stainless steel
Elektro-Messerentkeimer, Edelstahl Rostfrei
Armoire de sterilisation, inox
Esterilizador para cuchillos, inox

art.	dim. cm.	h.	V	W
49871-10	57,5x17	60	230	15

Costruzione in acciaio inox, porta in plexiglas, chiusura magnetica. Pulsante posizionato sulla parte inferiore. Programmabile da 0 a 2 ore. Dispositivo d'arresto all'apertura porta. Indice di protezione IP 24. Stainless steel construction, plexiglas door, magnetic lock. Switch positioned on the lower part. Timer setting from 0 up to 2 hours. Door with stop device when opening. Protection IP 24.



Sterilizzatore 40 coltelli ad 1 porta, inox
Knife sterilizer for 40 pcs, stainless steel
Elektro-Messerentkeimer, Edelstahl Rostfrei
Armoire de sterilisation, inox
Esterilizador para cuchillos, inox

art.	dim. cm.	h.	V	W
49871-20	103x17	60	230	30



Lavamani autonomo, inox
Autonomous hand wash basin, s/s
Mobiles Handwaschbecken
Lave-mains autonome, inox
Lavamanos portátil autónomo

art.	dim. cm.	h.
49873-26	41,5x34,5	120

Costruzione in acciaio inox, 2 ruote fisse e impugnatura per il trasporto. Vasca profondità mm 115. Comando a pedale. Il vano posteriore accoglie 2 taniche da 13 lt (1 per l'acqua pulita, 1 per l'acqua sporca). Completo di distributore sapone e

getta-carte agganciabile. Funzionamento con pompa elettrica con 2 batterie da 6 V fornite. - Stainless steel construction, 2 fixed casters and carrying handle. Bath depth 115 mm. Pedal control. The rear compartment accommodates 2 tanks of 13 liters (1 for clean water, 1 for dirty water). Complete with soap dispenser and bin. Electric pump operated with 2 6V batteries included.

COLTELLERIA KNIVES



Pungisalame
Salami pricker
Salamistachel
Pique saucisson
Picadura pra embutido

art.
42523-00



Ago tardellare, con becco, inox
Larding needle, with flap, stainless steel
Spicknadel, mit Klappe, E.R.
Lardoire à clapet, inox
Aguja con clip, inox

art. l. cm. Ø mm.
42514-20 20 5



Ago da cucina, inox
Lacing needle, straight, stainless steel
Dressiernadel, gerade, E.R.
Aiguille à brider, droite, inox
Aguja de cocina, inox

art. l. cm.
42515-18 18
42515-20 20



Ago da cucina, curvo, inox
Lacing needle, bent, stainless steel
Dressiernadel, gebogen, E.R.
Aiguille à brider, courbe, inox
Aguja de cocina, inox

art. l. cm.
42516-18 18
42516-20 20



Set 5 aghi, inox
Set 5 pcs needles, stainless steel
Nadelsatz, 5 Stk., E.R.
Set 5 aiguilles, inox
Set 5 agujas, inox

art.
42517-06



Gruppo sei spiedini, inox
Set 6 spits, stainless steel
Satz 6 Stk. Fleischspiess, E. R.
Set 6 brochettes, inox
Set 6 palos para asar, inox

art. l. cm.
42529-06 30



Taglia spiedini, inox
Kebabs preparation appliance, stainless steel
Spießbratenschneider, Edelstahl Rostfrei
Coupe-brochettes rapides, inox
Cortador para pinchos, inox

art. dim. cm. h. kg.
49877-12 16,5x12 28,5 2,2

Fornito con 12 spiedini. - Supplied with 12 skewer picks.



Spiedini piatti, 18/8
Skewers, 18/8
Fleischspiess, 18/8
Brochettes, 18/8
Pinchos, 18/8

art. dim. mm. u. pack
42511-20 200x3 10
42511-25 250x3 10
42511-30 300x3 10
42511-35 350x3 10
42511-40 400x3 10
42511-56 560x5 10

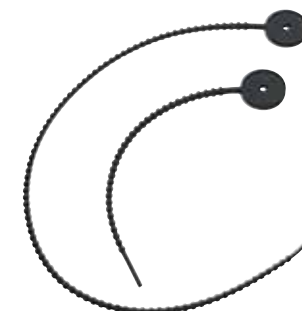

Laccetti da cucina, set 6 pezzi
Kitchen strings, 6 pcs set
Küche-Gurte, Satz 6 Stk.
Sangles, set 6 pcs.
Correas, juego 6 pz.

art. l. cm.
51595B44 22
51595B45 53

Laccetto da cucina in alternativa allo spago da cucina. Realizzato in silicone alimentare al 100%. - Silicone kitchen strings as alternative to twine and rope. Made of 100% food-grade silicone.



Spade, 18/8
Swords, 18/8
Schwerter, 18/8
Epées, 18/8
Espadas, 18/8

art. dim. mm.
42511-60 600x15x3
42511-70 700x15x3



Gancio ad ancora, inox
Anchor meat hook, stainless steel
Anker Fleischhaken, Edelstahl Rostfrei
Esse à ancre, inox
Gancho forma ancla, inox

art. Ø cm. l. u. pack
42507-12 0,7 13 10





Gancio girevole, inox
Sliving meat hook, stainless steel
Fleischdrehhaken, Edelstahl Rostfrei
Esse-tournante, inox
Gancho giratorio, inox

art.	Ø cm.	l.	u. pack
42525-27	1,2	27	10



Gancio fisso, 2 punte, inox
Meat hook, 2 peacks, stainless steel
Fleischhaken, 2 Spitze, E. R.
Crochet esse, 2 pointes, inox
Gancho 2 puntas, inox

art.	Ø cm.	l.	u. pack
42524-06	0,3	6	10
42524-08	0,4	8	10
42524-10	0,4	10	10
42524-12	0,5	12	10
42524-14	0,5	14	10
42524-16	0,6	16	10
42524-18	0,6	18	10
42524-20	0,9	20	10
42524-22	0,9	22	10
42524-30	1,2	30	10



Gancio fisso, 1 punta, inox
Meat hook, 1 peack, stainless steel
Fleischhaken, 1 Spitze, E. R.
Crochet esse, 1 pointe, inox
Gancho 1 punta, inox

art.	Ø cm.	l.	u. pack
42506-08	0,3	8	10
42506-10	0,4	10	10
42506-12	0,5	12	10
42506-14	0,5	14	10
42506-16	0,6	16	10
42506-18	0,6	18	10



Gancio girevole, inox
Sliving meat hook, stainless steel
Fleischdrehhaken, Edelstahl Rostfrei
Esse-tournante, inox
Gancho giratorio, inox

art.	Ø cm.	l.
42505-21	0,9	22
42505-24	1,0	26
42505-27	1,2	28
42505-50	1,2	50



Gancio scorrevole, inox
Meat hook, stainless steel
Fleischhaken, Edelstahl Rostfrei
Crochet coulissant, inox
Gancho, inox

art.	Ø cm.	l.	u. pack
42526-12	0,9	12	10
42526-14	1,2	14	10



Pinza per affettati, inox
Ham-tong, stainless steel
Schinkenlange, Edelstahl Rostfrei
Pince à jambon, inox
Pinza para jamón, inox

art.	cm.
42510-00	11x6



Batticarne a pugno, inox
Meat tenderizer, stainless steel
Kotelettklopfer, Edelstahl Rostfrei
Aplatisseur, inox
Aplasta carnes, inox

art.	Kg.
42501-15	1,5
42501-20	2,0



Batticarne a due tagli, inox
Meat tenderizer, stainless steel
Kotelettklopfer, Edelstahl Rostfrei
Aplatisseur, inox
Aplasta carnes, inox

art.	Kg.
42502-11	1,1



Batticarne a paletta, inox
Meat tenderizer, stainless steel
Kotelettklopfer, Edelstahl Rostfrei
Aplatisseur, inox
Aplasta carnes, inox

art.	Kg.
42503-10	1



Batticarne, alluminio
Steak hammer, aluminum
Aluminum-Fleischklopfer
Aplatisseur, alu
Aplasta carnes, aluminio

art.	l. cm.	Kg.
42508-00	32	0,6



Batticarne, alluminio
Steak hammer, aluminum
Aluminum-Fleischklopfer
Aplatisseur, alu
Aplasta carnes, aluminio

art.	l. cm.	Kg.
42508-01	25	0,41



Sega per ossa, inox
Bone-saw, stainless steel
Knochensäge, Edelstahl Rostfrei
Scie à os, inox
Sierra de cocina, inox

art.	l. cm.
48231-40	40
48231-45	45
48231-50	50

COLTELLERIA KNIVES



Pressa-hamburger, inox
Hamburger press, stainless steel
Hamburgerpresse, Edelstahl Rostfrei
Moule à steak, inox
Prensa para hamburguesa, inox

art.	dim. cm.	l.	
42864-00	11x8	36	oval
42864-10	10	36	round



Portaspago, inox
String holder, stainless steel
Schnurrolle-Halter, Edelstahl Rostfrei
Porte rolls sur socle, inox
Porta cuerda, inox

art.	dim. cm.	h.
42579-00	19x12	17



Portaspago, inox
String holder, stainless steel
Schnurrolle-Halter, Edelstahl Rostfrei
Porte rolls sur socle, inox
Porta cuerda, inox

art.	dim. cm.	h.
42579-01	17x14,5	20



Ferma prosciutto base legno
Ham stand on wood
Schinkenhalter, Holzsockel
Pince à jambon sur bois
Sujeta jamones, base madera

art.	dim. cm.	h.	kg.
41582-00	24x45	16	4,5



Ferma prosciutto base marmo
Ham stand on marble
Schinkenhalter, Marmorsockel
Pince à jambon sur marbre
Sujeta jamones, base mármol

art.	dim. cm.	h.	kg.
41583-00	24x45	15	10,3



Vassoio rettangolare, inox
Meat pan, stainless steel
Fleischblech, Edelstahl Rostfrei
Plat boucher, inox
Bandeja rectangular, inox

art.	dim. cm.	h.
42534-26	26x23	2
42534-32	34x21	2
42534-41	45x25	2



Vassoio espositore, inox
Display tray, stainless steel
Ausstellplateau, Edelstahl Rostfrei
Plateau, inox
Bandeja expositora, inox

art.	dim. cm.	h.
42532-29	29x21	2
42532-58	58x21	2



Contenitore con griglia, inox
Pan with grid, stainless steel
Plateau mit Siebeinsatz, E. R.
Plat boucher avec grille, inox
Contenedor con rejilla, inox

art.	dim. cm.	h.
42531-26	24,4x21,6	5,5
42531-32	32x23	5,5
42531-41	41x31	5,5
42531-50	50x35	



Contenitore, inox
Pan, stainless steel
Plateau, Edelstahl Rostfrei
Plat boucher, inox
Contenedor, inox

art.	dim. cm.	h.
42530-26	24,4x21,6	5,5
42530-32	32x23	5,5
42530-41	41x31	5,5
		5,5



Tritacarne elettrico
Electric meat mincer
Elektr. Fleischwolf
Hachoir électrique
Tritador de carne, eléctrico

art.	dim. cm.	h.	kg.	V	KW
49921-00	18x42	43	6	220-240	0,35

Produzione 60-80 kg/h. Dotazione: 3 griglie ø 3, 5, 8 mm, 3 imbuto ø 12, 18, 21 mm, accessorio kébbé. - Output 60-80 kg/h. Equipment: 3 plates ø 3, 5, 8 mm, 3 funnels ø 12, 18, 21 mm, kébbé unit.



Tritacarne elettrico
Electric meat mincer
Elektr. Fleischwolf
Hachoir électrique
Tritador de carne, eléctrico

art.	dim. cm.	h.	kg.	V	KW
49920-00	18x35	38	3,2	220-240	0,2

Dotazione: 2 griglie ø 5, 7 mm, 3 imbuto ø 12, 18, 21 mm, accessorio kébbé. Equipment: 2 plates ø 5, 7 mm, 3 funnels ø 12, 18, 21 mm, kébbé unit.



Accessorio grattugia
Grater accessory
Raffel für Fleischwolf
Accessoire bloc râpeur
Accessorio ralladora

art.	kg.
49921-10	1,6

Dotazione 3 cilindri: verdure, parmigiano, gruviera. - *Equipment 3 drums: rawness, parmesan, gruyère.*



Insacatrice verticale
Vertical manual sausage filler
Wurstfüller
Poussoir manuel vertical
Enscadora vertical

art.	dim. cm.	lt.	kg.
49876-03	30x22x47,5	3	6,2

Accessori: 3 imbuto.
Equipment: 3 funnels.



42518-50

42519-01

Ceppa in polietilene
PE butchers table
Hackstock, PE
Billot, PE
Cepa en polietileno

art.	dim.cm.	h.	mm.*
42518-50	50x50	86	50

* Spessore. - *Thickness.*

Copriceppa/Table board

42519-01	50x50	4	40
----------	-------	---	----



Spazzola per ceppa
Block brush, plastic handle
Blockbürste, Kunststoffgriff
Brosse à billot, matière plastique
Cepillo para cepa

art.	l. cm.
42518-01	20



Tagliere con vasca, PE
Cutting board with tray, PE
Tranchierbrett mit Tablett, PE
Planche à découper avec plateau, PE
Tabla de corte con bandeja, PE

art.	dim. cm.	h.
44947-00	33,5x46	5,5



Tagliere bar, PE
Cutting board, PE
Tranchierbrett, PE
Planche à découper, PE
Tabla de corte, PE

art.	dim. cm.	h.
42521-16	16x24,5	1
42521-24	24,5x32,5	1



03 = ROSSO / RED
Carni crude
Raw meat and poultry
Rohes Fleisch
Viande crue
Carne cruda

02 = MARRONE / BROWN
Verdure crude
Raw vegetables
Rohes Gemüse
Crudités
Verduras crudas

04 = BLU / BLUE
Pesce
Raw fish
Fisch
Poisson
Pescado

01 = GIALLO / YELLOW
Carni cotte
Cooked meats
Gekochtes Fleisch
Viande cuite
Carne cocida

05 = VERDE / GREEN
Insalata e frutta
Salads and fruits
Salat und Früchte
Salade et fruits
Ensalada y fruta

00 = BIANCO / WHITE
Pane e formaggi
Bakery and dairy products
Brot und Käse
Pain et fromages
Pan y quesos



Tagliere in polietilene HD
Cutting board, PE HD
Tranchierbrett, PE HD
Planche à découper, PE HD
Tabla de corte, PE HD

art.	dim. cm.	h.	GN
○42522-00	32x26,5	2	1/2
●42522-01	32x26,5	2	1/2
●42522-02	32x26,5	2	1/2
●42522-03	32x26,5	2	1/2
●42522-04	32x26,5	2	1/2
●42522-05	32x26,5	2	1/2
●42522-09	32x26,5	2	1/2

Tagliere in polietilene HD
Cutting board, HD polyethylene
Tranchierbrett, PE HD
Planche à découper, PE HD
Tabla de corte, PE HD

art.	dim. cm.	h.	GN
○42538-00	53x32,5	2	1/1
●42538-01	53x32,5	2	1/1
●42538-02	53x32,5	2	1/1
●42538-03	53x32,5	2	1/1
●42538-04	53x32,5	2	1/1
●42538-05	53x32,5	2	1/1
●42538-09	53x32,5	2	1/1

Tagliere in polietilene HD
Cutting board, HD polyethylene
Tranchierbrett, PE HD
Planche à découper, PE HD
Tabla de corte, PE HD

art.	dim. cm.	h.
○42539-00	60x40	2
●42539-01	60x40	2
●42539-02	60x40	2
●42539-03	60x40	2
●42539-04	60x40	2
●42539-05	60x40	2
●42539-09	60x40	2

UTENSILI KITCHEN UTENSILS



Tagliere con canalina, PE
Cutting board with groove, PE
Tranchierbrett, PE
Planche à découper avec rigole, PE
Tabla de corte con ranura, PE

art.	dim. cm.	h.	GN
○42546-00	65x53	2	2/1
●42546-01	65x53	2	2/1
●42546-02	65x53	2	2/1
●42546-03	65x53	2	2/1
●42546-04	65x53	2	2/1
●42546-05	65x53	2	2/1



Tagliere in PE HD, con fermi
Cutting board with stoppers, HD PE
Tranchierbrett mit Stiften, PE HD
Planche à découper avec arrêts, PE HD
Tabla de corte, PE HD

art.	dim. cm.	h.	GN
○42543-00	53x32,5	2	1/1
●42543-01	53x32,5	2	1/1
●42543-02	53x32,5	2	1/1
●42543-03	53x32,5	2	1/1
●42543-04	53x32,5	2	1/1
●42543-05	53x32,5	2	1/1



Tagliere in polietilene HD, con fermi
Cutting board with stoppers, HD PE
Tranchierbrett mit Stiften, PE HD
Planche à découper avec arrêts, PE HD
Tabla de corte, PE HD

art.	dim. cm.	h.
○42544-00	60x40	2
●42544-01	60x40	2
●42544-02	60x40	2
●42544-03	60x40	2
●42544-04	60x40	2
●42544-05	60x40	2



Set 6 taglieri colorati, polietilene
Set 6 colored cutting boards, PE
6 Stk. Tranchierbretter, Polyäthylen
6 planches à découper, PE
Juego 6 tabla de corte, PE

art.	dim. cm.	h.
42541-06	46x31	1,3



Raschietto, polietilene
Board scraper, PE
Blockschäber, PE
Racloir à planches, PE
Rascador, PE

art.	dim. cm.	h.
42520-00	17x6	9

Lama doppio taglio. - Double cut blade.

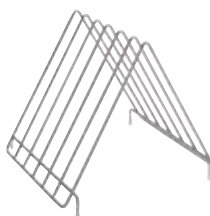

Portataglieri in filo, inox
Cutting board rack, stainless steel
Tranchierbretter-Träger, E. R.
Sechoir à planches à découper, inox
Porta tablas, inox

art.	dim. cm.	h.
42542-00	30x26	27,5



Tagliere tondo, PE
Round cutting board, PE
Tranchierbrett, rund, PE
Planche à découper, ronde, PE
Tabla de corte redonda, PE

art.	ø cm.	h.
42535-24	24,0	1,0
42535-32	32,5	1,5
42535-49	49,0	1,5



Tagliere in polietilene HD
Cutting board, HD polyethylene
Tranchierbrett, PE HD
Planche à découper, PE HD
Tabla de corte, PE HD

art.	dim. cm.	h.
42537-40	40x30	2
42537-50	50x30	2
42537-80	80x40	2



Tagliere in polietilene HD, con fermi
Cutting board with stoppers, HD PE
Tranchierbrett mit Stiften, PE HD
Planche à découper avec arrêts, PE HD
Tabla de corte, PE HD

art.	dim. cm.	h.
42540-40	40x30	2
42540-50	50x30	2
42540-80	80x40	2



Tagliere pane, legno
Bread cutting board, wood
Brotschneidbrett, Naturholz
Planche à découper en bois
Tabla de corte, madera

art.	dim. cm.	h.	GN
42964-53	53x32,5	2	1/1
42964-60	60x40	2	

ABBIGLIAMENTO PROFESSIONALE P TESSILE, MONOUSO, PROTETTIVO PROFESSIONAL WORK CLOTHING TEXTILE, DISPOSABLE, PROTECTIVE



Grebiule cuoco
 Chef apron
 Chef Schurz
 Tablier du chef
 Mandil chef



art. dim.cm
 48541-00 70x46 h.

100% cotone. - Cotton. - 185 g/mq.



Grebiule barman
 Barman apron
 Barman Schurz
 Tablier barman
 Mandil barman



art. dim.cm
 48543-01 70x40 h.

65% poliestere. - Polyester.
 35% cotone. - Cotton. - 195 g/mq.



Grebiule barman
 Barman apron
 Barman Schurz
 Tablier barman
 Mandil barman



art. dim.cm
 48543-02 70x40 h.

65% poliestere. - Polyester.
 35% cotone. - Cotton. - 195 g/mq.

UTENSILI KITCHEN UTENSILS



Giacca cuoco, maniche corte
 Chef jacket, short sleeve
 Chef Jacke, kurz Ärmel
 Veste de chef, manche courte
 Chaqueta chef, manga corta



Giacca cuoco, maniche lunghe
 Chef jacket, long sleeve
 Chef Jacke, lange Ärmel
 Veste de chef, manche longue
 Chaqueta chef, manga larga



Cappello cuoco
 Chef hat
 Chef-Kochmütze
 Chapeau de chef
 Gorro de papel pastel-cocinero



art. Taglia/Size

48530-01	S
48530-02	M
48530-03	L
48530-04	XL
48530-05	XXL

100% cotone. - Cotton - 185 g/mq.

art. Taglia/Size

48531-01	S
48531-02	M
48531-03	L
48531-04	XL
48531-05	XXL

100% cotone. - Cotton. - 185 g/mq.
 Incl. fazzolletto collo + set bottoni neri di ricambio. - With neckcloth + one set black spare knops.

art.

48540-00

100% cotone. - Cotton. - 185 g/mq.

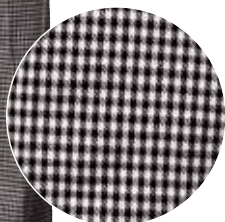

Pantaloni cuoco
 Chef trousers
 Chef Hosen
 Pantalon du chef
 Pantalones chef



Grebiule sommelier
 Sommelier apron
 Sommelier Schurz
 Tablier sommelier
 Delantal sommelier



Grebiule cameriere
 Waiter apron
 Ober Schurz
 Tablier garçon
 Delantal camarero



art. Taglia/Size

48536-01	42
48536-02	44
48536-03	46
48536-04	48
48536-05	50
48536-06	52
48536-07	54
48536-08	56
48536-09	58

100% cotone. - Cotton. - 185 g/mq.
 Incl. torcione. - With dish cloth.

art. dim.cm

48542-01 94x100 h.

65% poliestere. - Polyester.
 35% cotone. - Cotton. - 195 g/mq.

art. dim.cm

48544-02 90x110 h.

100% cotone. - Cotton. - 140 g/mq.



Grembiule di protezione
 Protective apron
 Schutzschürze
 Tablier de protection
 Delantal de protección

art. dim. cm.
 48501-76 75x55

EN ISO 13998 - Livello/Level 2
 Costituito da piastrine in alluminio di dimensioni 20x19x0,8 mm collegate da anelli in acciaio inossidabile ø 1 mm. Dotato di bretelle regolabili e staccabili. Made with aluminum plates dimensions 20x19x0,8 mm Stainless steel ring links ø 1 mm. Belt fastening with textile adjustable and detachable straps.



Guanto in cotta di maglia
 Chainmail glove
 Fingerhandschuhe
 Gant en cotte de mailles
 Guante de malla

art. taglia/size Col.
 48505-01 S bianco/white
 48505-02 M rosso/red
 48505-03 L blu/blue

Ambidestro, in acciaio AISI 316 L, anelli saldati, ø esterno 4 mm - ø del filo 0,5 mm, cinturino nylon. Fits either hands, made of stainless steel AISI 316 L, welded rings - external ø of the rings 4 mm - wire ø 0,5 mm, nylon strap.



Guanto lungo in cotta di maglia
 Chainmail glove, extended cuff
 Fingerhandschuhe, lang
 Gant en cotte de mailles, manchette longue
 Guante largo de malla

art. taglia/size Col.
 48506-01 S bianco/white
 48506-02 M rosso/red
 48506-03 L blu/blue



Guanto anti taglio
 Cut resistant glove
 Schnittschutz-Handschuh
 Gant anti-coupures
 Guantes protectores

art. taglia/size
 48523-01 S
 48523-02 M
 48523-03 L
 48523-04 XL

Guanto in fibra spectra in maglina a trama fine, resistenza al taglio livello massimo [EN388: livello 5], lavabile fino a 95°C, ambidestro. - Spectra fiber glove, fine weave knit, cut resistance maximum level [EN388: level 5], washable up to 95°C, ambidextrous.



Guanti anticalore a 3 dita (paio)
 Three-finger oven glove
 Backhandschuhe, 3 Finger
 Moufles protection thermique, 3 doigts
 Guantes de protección

art. l. cm.
 48517-03 15

Resistente al calore per contatto per 4/5 minuti in continua a + 100°C e 20 secondi in continua a + 360°C. - Contact heat resistant for 4/5 min. at +100°C and 20 sec. to a temperature of 360°C.



Guanti da forno (paio)
 Oven mitts
 Backhandschuhe
 Moufles de défournement
 Manoplas de protección

art. dim. cm.
 48513-02 26x14,5

In cotone speciale, colore naturale, esecuzione rinforzata palmo e pollice. Resistente fino a +200°C. Lavabile in lavatrice max. 40°C. - Special cotton fabric, natural color, reinforced palm and thumb. Heat resistant up to +200°C. Machine washable up to +40°C.



P

Guanto da forno
 Oven mitt
 Ofenhandschuh
 Moufle de défournement
 Manopla de protección

art. l. cm.
 48510-00 27,5

Tessuto esterno 100% cotone con rivestimento argenteo 100 g/mq. - Outer fabric 100% cotton with silver coating, 100 g/mq.



Guanti da forno (paio)
 Oven mitts
 Backhandschuhe
 Moufles de défournement
 Manoplas de protección

art. dim. cm.
 48511-02 34x16

In cotone speciale, colore naturale, esecuzione rinforzata palmo e pollice. Resistente fino a +200°C. Lavabile in lavatrice max. 40°C. - Special cotton fabric, natural color, reinforced palm and thumb. Heat resistant up to +200°C. Machine washable up to +40°C.



Guanti da forno (paio)
 Oven mitts
 Backhandschuhe
 Moufles de défournement
 Manoplas de protección

art. dim. cm.
 48512-02 27x15



Guanto da forno, silicone (1 pz.)
Oven mitt, silicone
Backhandschuhe, Silikon
Gant de protection, silicone
Manopla de protección, silicona

art.

48514-00

Ambidestro. Protegge le Vostre mani dal contatto con fiamme e teglie fino a 300°C, antiscivolo, stagno all'acqua e agli oli bollenti, lavabile in lavastoviglie.

Ambidextrous. Protects your hands from direct contact with flame and pans up to 300°C, non-slip, water and oil tight, dishwasher safe.



PATATE: Il guanto per patate è il più popolare. In taglia unica è ideale per pulire, lavare le patate in genere, come pure molte altre verdure.

VERDURE: Il guanto per verdure è un guanto universale. In taglia unica è ideale per pulire, lavare patate, radici, bietole, funghi, zucche/zucchine, mais e quant'altro.

PESCE: Il guanto per pesce è ideale per impugnare saldamente, pulire e strofinare frutti di mare e pesce. Il guanto include un innovativo inserto desquamante.

POTATO: *The potato glove is the most popular scrubbing glove. The glove is a one size fits all and ideal to scrub, rinse and clean new potatoes, baked potatoes and many other vegetables.*

VEGGIE: *The veggie glove is the universal vegetable glove. The glove is a one size fits all and ideal to scrub, rinse and clean potatoes, beet roots, radices, leaks, mushrooms, gourds, corn, and many more.*

FISH: *The fish glove is the perfect aid to hold, clean and scrub seafood and fish without getting smelly fingers. The glove includes the new and innovative de-scaling patch.*



Guanti scrub (1 paio)
Scrubbing gloves
Schrubben Handschuhe
Gants à scrubbing
Guantes para fregar

art.

taglia/size

48518-01 unica/one size



Guanti scrub (1 paio)
Scrubbing gloves
Schrubben Handschuhe
Gants à scrubbing
Guantes para fregar

art.

taglia/size

48518-02 unica/one size



Guanti scrub (1 paio)
Scrubbing gloves
Schrubben Handschuhe
Gants à scrubbing
Guantes para fregar

art.

taglia/size

48518-03 unica/one size

Non utilizzare su fonti di calore, forno, o BBQ, non mettere nel microonde. Idonei al contatto con alimenti. Realizzati in nylon resistente ma flessibile, lavabile in lavatrice e lavastoviglie. - *It is not an oven mitt, do not use on heat, oven, BBQ or do not put it in the microwave. Food-tested. Made with durable nylon, machine-washable and dishwasher-safe.*



Guanti in lattice (paio)
Sugar gloves
Zucker-Handschuhe
Gants à tirer le sucre
Guantes de látex

art.

T./size

48516-07 7 - 7 1/2

48516-08 8 - 8 1/2

48516-09 9 - 9 1/2



Guanti blu, nitrile
Blue gloves, nitrile
Blau-Handschuhe, Nitril
Gants en nitrile, bleu
Guantes azules, nitrile

art.

T./size

u. pack

48519-01 S 100

48519-02 M 100

48519-03 L 100

48519-04 XL 100



Guanti in polietilene HD
Gloves, HD polyethylene
HD Polyethylen Handschuhe
Gants en polyéthylène HD
Guantes de polietileno HD

art.

l. cm

u. pack

48522-24 24 500

Taglia unica, finitura palmo e dita microgrip. - *One size, palm and fingers microgrip finishing.*

Guanto monouso in nitrile. Trattamento Powder free - Peso 4,5 gr/M - Finitura Microgrip. Privo di polvere. I valori di durata sono associati ad una ottima resistenza chimica e ad una buona protezione meccanica (resistenza alla trazione e perforazione). Non contiene fattori allergizzanti essendo un prodotto Latex free. - *Disposable nitrile glove. Treatment Powder free - Weight 4,5 gr/M - Finish microgrip. Free of dust. The duration values offered by this glove are associated with a very good chemical resistance and a good mechanical protection (tensile and puncture strength). Do not contain allergens being a Latex-free product.*



Grembiule LDPE
Apron, LDPE
Schurz, LDPE
Tablier, LDPE
Delantal, LDPE

art.	dim. cm	u. pack
48524-75	75x120	50

Impermeabile e resistente, lunghezza 120 cm dal petto, totale 140 cm. - *Water-proof and resistant, length 120 cm from the chest, total length 140 cm.*



Cappello Grand Chef, carta
Paper Chef's hat
Kochmütze, Papier
Toque papier
Tocado, papel

art.	h. cm	u. pack
48520-20	20	20

Carta crespata doppia lavorazione, fascia assorbi sudore, adesivo regolabile, areato. - *Double crepe paper processing, absorbent, adjustable size, ventilated.*



Cappello Grand Chef, carta
Paper Chef's hat
Kochmütze, Papier
Toque papier
Tocado, papel

art.	h. cm	u. pack
48520-23	23	20



Cappello Grand Chef, carta
Paper Chef's hat
Kochmütze, Papier
Toque papier
Tocado, papel

art.	h. cm	u. pack
48520-30	30	20

Carta crespata doppia lavorazione, fascia assorbi sudore, adesivo regolabile, areato. - *Double crepe paper processing, absorbent, adjustable size, ventilated.*



Cappello Monsieur Chef, TNT
Chef's hat, TNT
Chef-Kochmütze, tnt
Toque plissée chef, TNT
Gorro Chef, TNT

art.	u. pack
48529-00	20

Tnt-polipropilene, plissettato, fascia assorbi sudore, adesivo regolabile per fissare la taglia. - *Tnt-polypropylene, pleated, band absorb sweat, adjustable adhesive to fix the size.*



Bustina carta
Paper cap
Papier-Mütze
Calot papier
Barco papel

art.	u. pack
48528-00	100

Carta doppia lavorazione, fascia assorbi sudore, adesivo regolabile, aerata. - *Double paper processing, absorbent, adjustable size, ventilated.*



Cuffia, TNT
Cap, TNT
Haarkappe, TNT
Charlotte, TNT
Red cabello, TNT

art.	u. pack
48527-00	100

Cuffia plissettata TNT 16gr/m2, molto leggera, morbido elastico, ø 50 cm. - *Pleated cap, TNT 16gr/m2, very light, soft elastic, ø 50 cm.*



Kit visitatore, TNT
Visitor kit, TNT
Besucher-Kits, TNT
Kit visiteur, TNT
Conjunto visitador, TNT

art.
48525-03

Composta da 1 camice e cuffia in TNT e 1 set copriscarpe CPE. - *Composed: 1 TNT overall and cap, 1 CPE overshoes.*



Copriscarpe, PE
Overshoes, PE
Überschuhe, PE
Sur-chaussures, PE
Cubrezapatos, PE

art.	l. cm	u. pack
48526-44	44	110

PE doppio spessore, impermeabili, elastico alla caviglia, fondo gofrato. - *PE double-thickness, waterproof, elastic ankle, embossed bottom.*

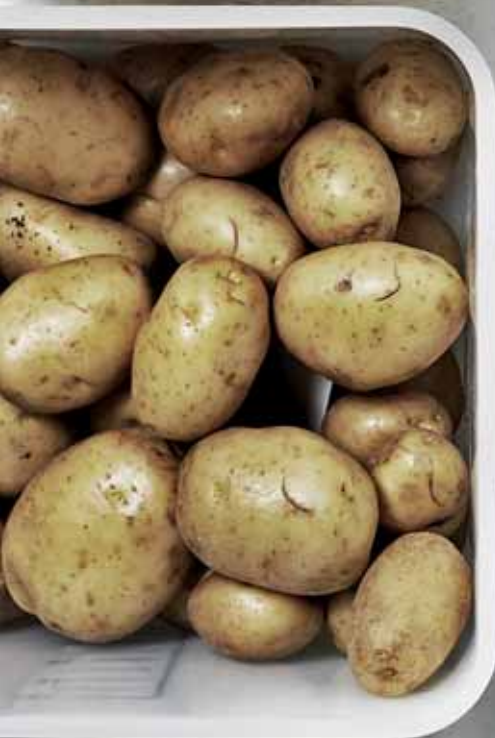

STOCCAGGIO E TRASPORTO
STORAGE & TRANSPORT
LAGERUNG UND TRANSPORT
STOCKAGE & TRANSPORT
ALMACENAMIENTO Y TRANSPORTE

SERIE 14000

CESTELLI
WASHRACKS

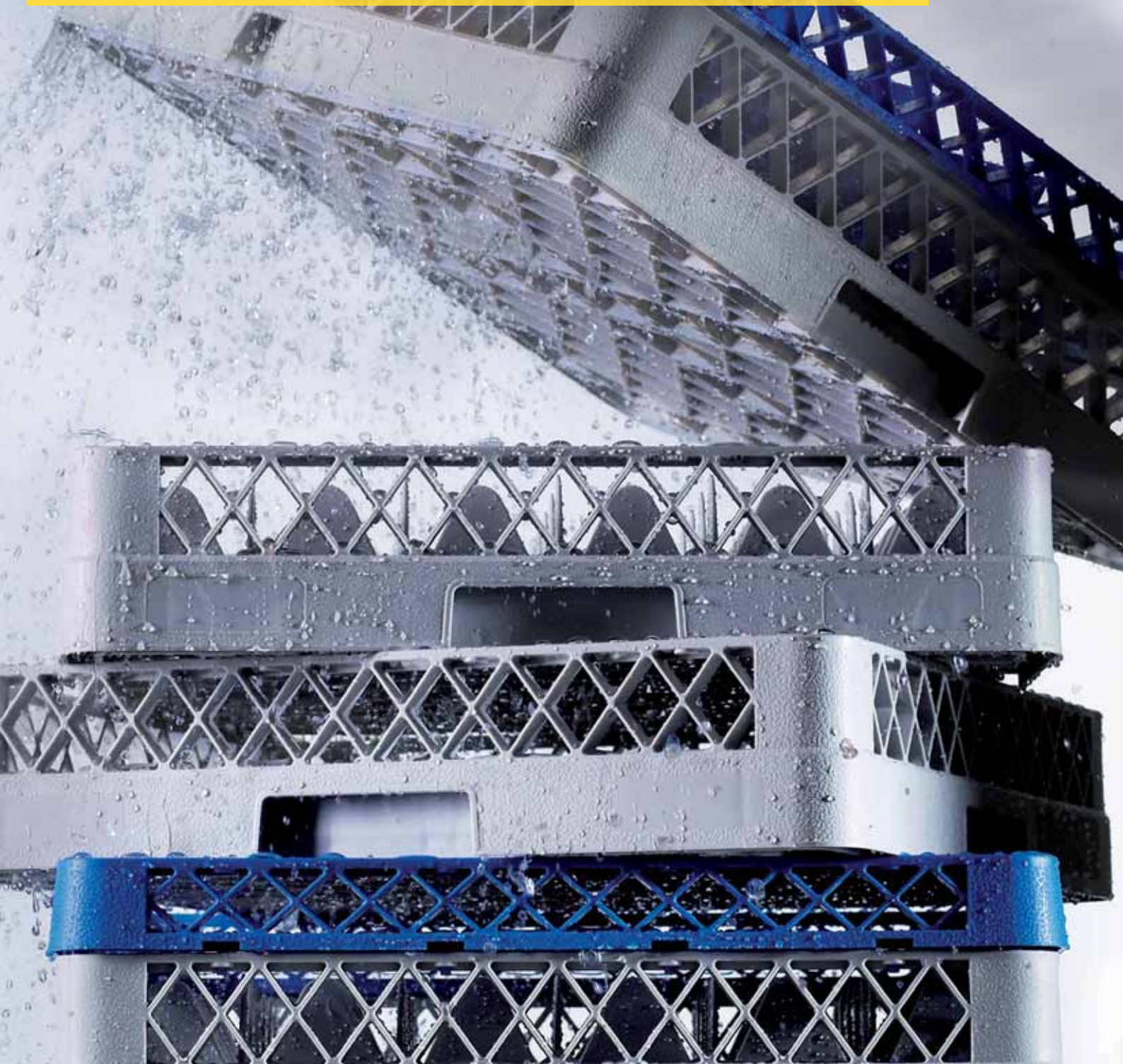

Realizzati in polipropilene, stampati uniprezzo a doppio spessore. Resistenti agli urti ed alte temperature, agenti chimici e residui alimentari. Concepiti per assicurare una protezione ottimale a bicchieri e stoviglie, il loro design permette inoltre una perfetta circolazione dell'acqua di lavaggio ed una rapida e perfetta asciugatura. Facili e veloci da impilare. Leggeri e maneggevoli, tutti i cestelli di base sono dotati di maniglie integrali su tutti i lati.

Molded in one-piece with double-wall construction made of polypropylene. Resistant to shock, high temperatures and chemicals. Designed to give optimum protection to glass and chinaware as well as to maximise water circulation and drying in professional dishwasher. Easy and quickly stackable without tools or screws. Base racks have comfortable hand grips on all four sides facilitating handling.



Cestello 9 bicchieri
9-Compartment base
Grundkorb für 9 Gläser
Panier de base 9 verres
Cesta 9 compartimentos

art.	dim. mm.	h.
14001-09	500x500	103

Scomparti/Compartments 151x151x88
ø max 151 mm.



Estensore per cestello 9 bicchieri
9-Compartment extender
Aufsatz zum Grundkorb für 9 Gläser
Réhausse pour panier de base 9 verres
Extensión 9 compartimentos

art.	dim. mm.	h.
14003-09	500x500	45

Scomparti/Compartments 151x151x42
ø max 151 mm.



Cestello 16 bicchieri
16-Compartment base
Grundkorb für 16 Gläser
Panier de base 16 verres
Cesta 16 compartimentos

art.	dim. mm.	h.
14001-16	500x500	103

Scomparti/Compartments 112x112x88
ø max 112 mm.



Estensore per cestello 16 bicchieri
16-Compartment extender
Aufsatz zum Grundkorb für 16 Gläser
Réhausse pour panier de base 16 verres
Extensión 16 compartimentos

art.	dim. mm.	h.
14003-16	500x500	45

Scomparti/Compartments 112x112x42
ø max 112 mm.



Cestello 25 bicchieri
25-Compartment base
Grundkorb für 25 Gläser
Panier de base 25 verres
Cesta 25 compartimentos

art.	dim. mm.	h.
14001-25	500x500	103

Scomparti/Compartments 88x88x88
ø max 88 mm.



Estensore per cestello 25 bicchieri
25-Compartment extender
Aufsatz zum Grundkorb für 25 Gläser
Réhausse pour panier de base 25 verres
Extensión 25 compartimentos

art.	dim. mm.	h.
14003-25	500x500	45

Scomparti/Compartments 88x88x42
ø max 88 mm.



Cestello 36 bicchieri
36-Compartment base
Grundkorb für 36 Gläser
Panier de base 36 verres
Cesta 36 compartimentos

art.	dim. mm.	h.
14001-36	500x500	103

Scomparti/Compartments 73x73x88
ø max 73 mm.



Estensore per cestello 36 bicchieri
36-Compartment extender
Aufsatz zum Grundkorb für 36 Gläser
Réhausse pour panier de base 36 verres
Extensión 36 compartimentos

art.	dim. mm.	h.
14003-36	500x500	45

Scomparti/Compartments 73x73x42
ø max 73 mm.



Cestello 49 bicchieri
49-Compartment base
Grundkorb für 49 Gläser
Panier de base 49 verres
Cesta 49 compartimentos

art.	dim. mm.	h.
14001-49	500x500	103

Scomparti/Compartments 62x62x88
ø max 62 mm.



Estensore per cestello 49 bicchieri
49-Compartment extender
Aufsatz zum Grundkorb für 49 Gläser
Réhausse pour panier de base 49 verres
Extensión 49 compartimentos

art.	dim. mm.	h.
14003-49	500x500	45

Scomparti/Compartments 62x62x42
ø max 62 mm.



Estensore aperto
Open extender
Universalrand ohne Einteilung
Réhausse sans cloisons
Extensión abierta

art.	dim. mm.	h.
14004-00	500x500	42



Coperchio per cestelli
Rack cover
Deckel für Körbe
Couvercle à panier
Tapa para cestas

art.	dim. mm.	h.
14011-00	505x505	25

STOCCAGGIO E TRASPORTO STORAGE & TRANSPORT



Cestello universale
Open rack
Universal-Korb
Panier universel
Cesta universal

art.	dim. mm.	h.
14010-00	500x500	103



Cestello per posate
Cutlery rack
Besteckkorb
Panier à couverts
Cesta para cubiertos

art.	dim. mm.	h.
14006-00	500x500	103



Cestello per piatti e vassoi
Plates & trays rack
Tablett- u. Tellerkorb mit Fingern
Panier à plateaux et assiettes
Cesta para bandejas y platos

art.	dim. mm.	h.
14008-00	505x505	103

Per 18 piatti piani oppure 9 vassoi max. 460 mm. - For 18 flat plates or 9 trays max. 460 mm.



Cestello per vassoi, aperto
Tray rack, open
Tablettkorb mit Fingern, offen
Panier à plateaux, ouvert
Cesta abierto para bandejas

art.	dim. mm.	h.
14007-00	500x500	103

Per vassoi oltre 460 mm. Cap. 9 pezzi.
For trays over 460 mm. Capacity 9 pieces.



Etichette di identificazione
Clip tags
Markierungsklipp
Clips
Etiquetas

art.	dim. mm.	pz. / pcs
14013-00	80x40	10



Cestello per posate 8 scomparti
Cutlery holder 8 compartments
Besteckkorb, 8 Unterteilungen
Panier à couverts 8 compartiments
Cesta para cubiertos

art.	dim. mm.	h.
14015-08	426x206	150

Per 200/250 posate.
For 200/250 pcs cutlery.



Recipiente, polipropilene
Multipurpose box, polypropylene
Behälter, Polypropylen
Conteneur multiservice, PP
Contenedor, PP

art.	dim. cm.	h.
42585-06	54x33	13



Cestello porta posate, inox
Cutlery holder, stainless steel
Besteckbehälter, Edelstahl Rostfrei
Réceptient à couverts, inox
Cestillo para cubiertos, inox

art.	Ø cm.	h.
42586-10	10	14



Cestello porta posate, polietilene
Cutlery holder, polyethylene
Besteckbehälter, Polyäthylene
Réceptient à couverts, polyéthylène
Cestillo para cubiertos, PE

art.	Ø cm.	h.
42586-09	9,5	13,5



Porta posate, inox
Cutlery dispenser, stainless steel
Besteckbehälter, Edelstahl Rostfrei
Réceptient à couverts, inox
Contenedor para cubiertos, inox

art.	dim. cm.	h.
42587-04	26x30	20



Porta posate, polietilene
Cutlery box, polyethylene
Besteckbehälter, Polyäthylene
Ramasse-couverts, polyéthylène
Contenedor para cubiertos, PE

art.	dim. cm.	h.
42585-04	GN 1/1	10



Coperchio per porta posate, PP
Cutlery box lid, PP
Deckel für Besteckbehälter, PP
Couverture pour ramasse-couverts, PP
Tapa para contenedor cubiertos, PP

art.	dim. cm.	h.
42585-00	32,5x53	2



Carrello con maniglione
Dolly with handle
Transportwagen mit Griff
Chariot avec poignée
Carretilla con manillar

art.	dim. cm.	h.	Kg.
44023-00	54x54	76	10

Base in PP. - Polypropylene base.



Carrello senza maniglione
Dolly without handle
Transportwagen ohne Griff
Chariot sans poignée
Carretilla sin manillar

art.	dim. cm.	Kg.
44024-00	54x54	8,5

Base in PP. - Polypropylene base.



Carrello con maniglione, inox
Dolly with handle, stainless steel
Transportwagen mit Griff, E. R.
Chariot avec poignée, inox
Carretilla con manillar, inox

art.	dim. cm.	carico/load
44025-50	55x55x9	kg 60

Manico estraibile, tappo di scarico.
Removable handle, with drip and drain plug.



Carrello, inox
Dolly, stainless steel
Transportwagen, Edelstahl Rostfrei
Chariot, inox
Carro, inox

art.	dim. cm.
44975C50	51x51



N

Copertura protettiva con cerniera, PVC
Dust cover with zipper
Schutzhülle mit Reißverschluss
Housse de protection avec zip
Cuberta protectora con cremallera

art.	dim. cm.	h.
44020-10	58,5x60	162



Copertura protettiva
Dust cover
Schutzhülle
Housse de protection
Cuberta protectora

art.	dim. cm.	h.
44009-00	55x55	122



N

Carrello porta cestelli, inox
Washrack trolley, stainless steel
GläserKörbe-Wagen, Edelstahl R.
Chariot pour casiers à vaisselle, inox
Carro para cestas vajillas, inox

art.	dim. cm.	h.
44020-21	100x50	178,5

3 livelli carico verticale, 24 cestelli.
3 levels, suitable for 24 racks.



N

Carrello porta cestelli, inox
Washrack trolley, stainless steel
GläserKörbe-Wagen, Edelstahl R.
Chariot pour casiers à vaisselle, inox
Carro para cestas vajillas, inox

art.	dim. cm.	h.
44020-01	63x63	178,5

8 livelli di carico orizzontale. - 8 levels.

STOCCAGGIO E TRASPORTO STORAGE & TRANSPORT



Carrello portapiatti, inox
Dish dolly, stainless steel
Teller-Transportwagen, Edelstahl Rostfrei
Chariot porte-assiettes, inox
Carro porta platos, inox

art.	dim. cm.	h.	Carico/load max kg.
44027-00	74x61	81	240

Costruzione in acciaio inox. Arcata in tubo 25x25 mm. 4 ruote girevoli ø 125 mm. di cui 2 con freno, in gomma non tracciante, calotta in poliammide. Fornito con 2 griglie di separazione/anti-caduta regolabili, in filo inox ø 6 mm. Per piatti fino a ø 290 mm.. - *Stainless steel construction. Side rail tube 25x25 mm. 4 swivel casters ø 125 mm. 2 with brake, non-tracing rubber, cap made of polyamide. Supplied with 2 adjustable separation grids, stainless steel wire ø 6 mm. For dishes up to ø 290 mm.*



Carrello portapiatti regolabile, PE
Adjustable dish dolly, PE
Teller-Transportwagen, einstellbar, PE
Chariot de stockage d'assiettes réglable, PE
Carro ajustable para platos, PE

art.	dim. cm.	h.	kg.
49304-06	73x73	81,5	28

Carrello fornito con copertura vinilica e 4 divisori. Per piatti ø cm16-32, capienza 180/400 pezzi. *Each cart is delivered with dust cover and 4 dividers. Dishes ø cm 16-32, capacity 180/400 pcs.*



Recipiente, PP
Multipurpose box, PP
Behälter, PP
Conteneur multiservice, PP
Contenedor, PP

art.	dim. cm.	h.
44031-04	52x39	12,7
44031-05	52x39	17,7

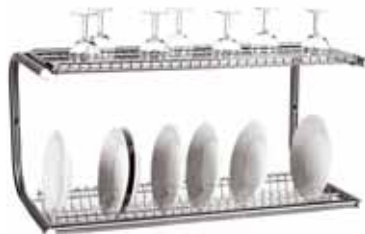

Scolapiatti a muro, inox
Wall draining rack, stainless steel
Wand-Trockengestell, Edelstahl Rostfrei
Egouttoir au mur, inox
Escurreidor mural de platos, inox

art.	dim. cm.	carico/load
44029-00	87x30x20	kg 70

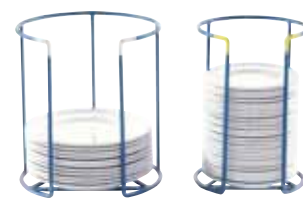

Porta piatti in filo metallo/rilsan
Wire dish rack
Tellergestell
Porte-assiettes
Porta platos

art.	Ø cm.	h.
44047-17	17	30
44047-19	19	30
44047-22	22	30
44047-25	25	30
44047-28	28	30



Bicchieri acqua, PC
Water tumbler, PC
Wasserglas, PC
Verre à eau, PC
Vaso agua, PC

art.	Ø cm.	h.	ml.	u. pack
44871-20	7,0	7,0	170	10
44871-21	7,0	10,2	250	10
44871-22	7,8	11,4	350	10

Impilabile. - *Stackable.*



Coperchio con beccuccio, PP
Cover with spout, PP
Deckel mit Ausguss, PP
Couvercle avec bec, PP
Tapa con boquilla, PP

art.	Ø cm.	u. pack
44871-23	7	50



Vassoio isoteramico, PP
Isothermic tray, PP
Thermo-Tablett, PP
Plateau isotherme, PP
Bandeja isotérmica, PP

art.	dim. cm.	h.
44871-00	57x37	11

Stoviglie escluse, vedi pagina seguente. Dishes not included, see next page.
Bordi rotondi ed angoli a norma, senza spigoli. Interno isolante in poliuretano. Può accogliere stoviglie in porcellana o in PC. Coperchio e vassoio sono tra loro impilabili. Incavo laterale per l'inserimento di una etichetta. - *Rounded edges smooth form and non sharp corners with insulating polyurethane interior. Both polycarbonate and chinaware may be used with the tray. Both bases and covers are stackable. A card holder can be fixed to the side of the tray to indicate the username and their diet.*

BASE + COPERCHIO
BASE + LID



Porta scheda
Card holder
Tablett-Etikettenhalter
Porte-carte
Portatarjetas

art. dim. cm.
44871-AA 5,8x2,8x2

SCUOLE/SCHOOLS - OSPEDALI/HOSPITALS - RESIDENCE - CATERING

Vasellame in polycarbonato. Riduce considerevolmente il peso, è impilabile e infrangibile. Sopporta temperature tra i -30°C ed i +120°C. Adatto a lavastoviglie e microonde. - Polycarbonate holloware considreably reduces weight, is unbreakable and stackable. Can withstand temperatures between -30°C and +120°C. Dishwasher and microwave safe.



Piatto piano, PC
Flat plate
Teller, flach
Assiette plate
Plato llano

art. Ø cm.
44871-01 23,3
44871-05 17,5



Piatto piano frutta, PC
Flat plate
Teller, flach
Assiette plate
Plato llano para fruta

art. Ø cm.
44871-02 20,6



Piatto fondo, PC
Soup plate
Suppenteller
Bol à soupe
Plato hondo

art. Ø cm.
44871-03 18,5



Coperchio ermetico PP
Hermetic cover
Hermetische Abdeckung für 44871-03
Couvercle hermétique
Tapa hermética

art. Ø cm. per/for art.
44871-04 19 44871-03



Bolo, PC
Bowl
Schüssel
Bol
Tazón

art. Ø cm.
44871-06 12,5



Bolo isotermico, PC
Insulated bowl
Isolierschüssel
Bol isotherme
Tazón isotérmico

art. Ø cm.
44871-07 12,5



Coperchio ermetico per bolo, PP
Bowl hermetic lid
Hermetische Deckel für Schüssel
Couvercle hermétique pour bol
Tapa hermética para tazón

art. Ø cm. per/for art.
44871-08 13 44871-06/-07



Terrina, PC
Rectangular bowl
Rechteckige Schüssel
Ravier rectangulaire
Fuente rectangular

art. dim. cm. h.
44871-09 13,8x9,5 4,5



Ciotola quadrata, PC
Square bowl
Rechteckige Schüssel
Ravier carrée
Fuente cuadrada

art. dim. cm. h.
44871-10 11,8x11,8 4,7



Tazza isotermica, PC
Isothermic coffee cup
Isolierkaffee tasse
Tasse isotherme
Taza isotérmica

art. ø cm. h.
44871-11 8,4 7,5



Coperchio per tazza, PP
Cover for cup
Deckel für Tasse
Couvercle pour tasse
Tapa para taza

art. Ø cm. per/for art.
44871-12 8,7 44871-11
44871-14 9,5 44871-13



Tazza caffè, PC
Coffee cup
Kaffee tasse
Tasse à café
Taza café

art. ø cm. h.
44871-13 9,4 6,8

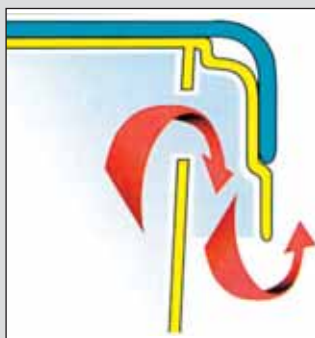

Contenitori in polipropilene trasparente per alimenti. Estremamente resistenti alle sollecitazioni, offrono protezione sicura nel trasporto. Dimensioni adatte a EURO-pallets. Adatti al lavaggio in lavastoviglie, design studiato per consentire il defluire dell'acqua. Coperchi di colore diverso facilitano l'individuazione del contenuto. Impilabili, a pieno la loro robustezza consente un'elevata capacità di sovrapposizione. Fessure di aerazione per un costante ricambio d'aria.

Clear polypropylene construction, full compliance with food contact requirements. A removable tower insert provides total flexibility. Strong, it prevents dish breakage in transport. Dimensions suitable to EURO-pallets. Lids are tightly fitting, hygienic, dish-washer safe. Covers available in different colors, assure easy and quick content identification. Stackable once empty, their strongness provides high loading density once full. Ventilation holes assure constant aircirculation. Design studied to enable water flow while washing.



Contenitore, polipropilene
Polypropylene box
Korb, Polypropylen
Panier en polypropylène
Contenedor en polipropilene

art.	dim. cm.	h. cm.	lt.
44040-40	40x40	31,5	32

Fondo piatto
Base insert
Flach-Einsatz
Plateau double fond
Base plana

art.	dim. cm.
44042-00	40x40

Inserto croce
Cross insert
Kreutz-Einsatz
Cloison à croix
Separador a cruz

art.	dim. cm.
44043-00	40x40



Coperchio, polipropilene
Polypropylene cover
Deckel, Polypropylen
Couvercle en polypropylène
Tapa en polipropilene

art.	colore/color
44041-00	trasparente/clear
44041-01	giallo/yellow
44041-03	rosso/red

Coperchio, polipropilene
Polypropylene cover
Deckel, Polypropylen
Couvercle en polypropylène
Tapa en polipropilene

art.	colore/color
44041-04	blu/blue
44041-05	verde/green

Tubo fermapiatti
Tower insert
Rohr-Einsatz
Tuyau
Tubo

art.
44044-00

CONTENITORI QUADRATI - SQUARE CONTAINERS



Contenitori impilabili. Disponibili in un copoliestere alternativo privo di bisfenolo A (BPA free) trasparente per identificare il contenuto o in resistente polietilene bianco. Graduati: rosso USA e blu per i litri. Impugnature resistenti per un trasporto più pratico e fori di drenaggio per il lavaggio e un'asciugatura accurata. I contenitori in copoliestere resistono a temperature comprese fra i -40°C e i 100°C. I contenitori in polietilene resistono a temperature comprese fra i -28°C e i 65°C. Lavabili in lavastoviglie. Coperchi con linguetta con chiusura ermetica a pressione. Disponibili in due misure adattabili a tutti i contenitori. *Square stackable containers. Available in clear copolyester (BPA-free) for visibility or in white polyethylene. Smooth surfaces for easy cleaning. Precise measurement gradations in red/blue. User-friendly, easy-grip handles with dishwasher drain hole. Nest for compact storage. Temperature range, copolyester containers: -40°C to 100°C. Temperature range, polyethylene containers: -28°C to 65°C. Dishwasher safe. Tight-fitting lids with flap. Available in two sizes to fit all containers.*



Contenitore per alimenti, copoliestere
Food container, copolyester
Nahrungsmittel-Behälter, Copoliéster
Conteneur pour aliments, copolyester
Contenedor para alimentos, copolyester

art.	dim. cm.	h.	lt.
44620-01	22,2x21,1	6,8	1,9
44620-02	22,2x21,1	12,1	3,8
44620-03	22,2x21,1	17,6	5,7
44620-04	22,2x21,1	22,2	7,6
44620-05	28,7x26,7	19,7	11,4
44620-06	28,7x26,7	30,3	17,0
44620-07	28,7x26,7	36,7	20,8

Contenitore per alimenti, PE
Food container, PE
Nahrungsmittel-Behälter
Conteneur pour aliments
Contenedor para alimentos

art.	dim. cm.	h.	lt.
44624-03	22,2x21,1	17,6	5,7
44624-04	22,2x21,1	22,2	7,6
44624-05	28,7x26,7	19,7	11,4
44624-06	28,7x26,7	30,3	17,0
44624-07	28,7x26,7	36,7	20,8

Coperchio, PE
Lid, PE
Deckel
Couvercle
Tapa

art.	dim. cm.
44620-14	22,2x21,1
44620-17	28,7x26,7

CONTENITORI ROTONDI - ROUND CONTAINERS



La forma tonda permette una migliore circolazione dell'aria per la conservazione in frigorifero o congelatore. Impilabili con maniglie, in polipropilene trasparente. Resistono a temperature comprese fra i -28°C e i 65°C. Lavabili in lavastoviglie. I coperchi sono a chiusura ermetica con doppia barriera e linguetta di apertura nell'angolo. Consentono l'indicazione della data e del contenuto in un'apposita area di scrittura. Disponibili in due misure adattabili a tutti i contenitori. *In clear polypropylene. Stackable. Nest for compact storage. Reinforced rim for added strength. User-friendly, easy grip handles with dishwasher drain hole. Temperature range: -28°C to 65°C. Dishwasher safe. Tight-fitting lids with double barrier and opening flap in the corner. Writing area on the cover to specify date and content. Available in two sizes to fit all containers.*



Contenitore per alimenti, PP
Food container, PP
Nahrungsmittel-Behälter
Conteneur pour aliments
Contenedor para alimentos

art.	ø cm.	h.	lt.
44625-04	25,4	27,0	7,6
44625-05	33,3	20,6	11,4
44625-06	33,3	30,2	17,0
44625-07	33,3	35,6	20,8
44625-08	33,3	35,6	20,8

Con manico / With handle

Coperchio, PE
Lid, PE
Deckel
Couvercle
Tapa

art.	ø cm.	h.
44625-26	26,0	2,5
44625-34	34,3	3,2



Contenitore per alimenti
Food container
Nahrungsmittel-Behälter
Conteneur pour aliments
Contenedor para alimentos

Vasca di drenaggio
Drain tray
Abtropf-Behälter
Conteneur perforé
Contenedor papa colar

Coperchio
Lid
Deckel
Couverture
Tapa

art.	dim. cm.	h.	lt.
49384-03	45,7x30	22,9	19,0
49384-04	45,7x66	8,9	19,0
49384-05	45,7x66	15,0	32,3
49384-06	45,7x66	23,0	47,0
49384-07	45,7x66	38,0	81,5

art.	dim. cm.	h.
49384-11	45,7x66	12

art.	dim. cm.	da/a - from/to
49384-14	45,7x30	7,6 → 19 lt.
49384-15	45,7x66	32,2 → 81,5 lt.



Contenitore per alimenti, PP
Food container, PP
Nahrungsmittel-Behälter, PP
Conteneur pour aliments, PP
Contenedor para alimentos, PP

Carrello per derrate alimentari, PP
Storage container, PP
Vorratsbehälter, PP
Chariot mobile de stockage, PP
Contenedor para hortalizas, PP

Carrello, inox
Mobile rack, stainless steel
Fahrbares Gestell, Edelstahl Rostfrei
Chariot mobile, inox
Carrito, inox

art.	dim. cm.	h.	lt.
49382-10	30x38	21,6	10,0
49382-23	60x29	43,0	23,5
49382-47	60x49	43,0	47,0

art.	dim. cm.	h.	lt.
49381-01	74x33,5	71	79,0
49381-02	75x39,5	71	97,5
49381-03	75,5x45,5	71	116,0

art.	dim. cm.	h.
49383-00	36x97	121,3

Carrello per stoccaggio dei contenitori per alimenti. Ogni ripiano può contenere un contenitore Maxi (49382-47 lt 47,0) o due contenitori Midi (49382-23 lt 23,5).
Cart and bins work together. Cart shelves have safety positioning locators to securely store and transport bins. Each shelf holds two 49382-23 or one 49382-47 bin.





Contenitore tondo, PE
Container, round, PE
Behälter, Rund, PE
Conteneur, rond, PE
Contenedor redondo, PE

art.	ø cm.	h.	lt.
49373-01	39,7	43,5	37,9
49373-02	49,5	58,1	75,7
49373-03	55,9	69,2	121,1
49373-04	67,3	83,8	208,2



Coperchio tondo, PE
Lid, round, PE
Deckel, Rund, PE
Couvercle, rond, PE
Tapa redonda, PE

art.	ø cm.	h.
49373-11	40,6	2,5
49373-12	50,5	3,2
49373-13	56,5	3,5
49373-14	67,9	5,1



Contenitore quadro, PE
Container, square, PE
Behälter, vierecking, PE
Conteneur carré, PE
Contenedor cuadrado, PE

art.	dim. cm.	h.	lt.
49374-01	54,6x54,6	57,2	106
49374-02	59,7x59,7	73,0	151,4



Coperchio quadro, PE
Lid, square, PE
Deckel, vierecking, PE
Couvercle carré, PE
Tapa cuadrada, PE

art.	dim. cm.	h.
49374-11	56x56	5,1
49374-12	61x61	5,1



Supporto mobile tondo, PE
Dolly, round, PE
Wagen, Rund, PE
Chariot, rond, PE
Soporte móvil redondo, PE

art.	ø cm.	h.	carico/load
49373-90	46,4	16,8	kg. 113,4



Supporto mobile quadro, PE
Dolly, square, PE
Wagen, vierecking, PE
Chariot carré, PE
Soporte móvil cuadrado, PE

art.	dim. cm.	h.	carico/load
49374-90	44x44	16	kg. 113,4



Carrello vasca, inox
Sink trolley, stainless steel
Gemüsewaschwagen, Edelstahl Rostfrei
Chariot à evier, inox
Carretilla para verduras, inox

art.	dim. cm.	h.
44028-00	86x66	100

Con 4 ruote pivotanti di cui 2 con freno.
4 swivel casters, 2 with brakes.



Contenitore con coperchio
Space saving box with cover
Behälter mit Deckel
Récipient avec couvercle
Contenedor con tapa

art.	dim. cm.	h.
44033-23	66x45	23
44033-38	67x46	38

Sovrapponibile e impilabile.
Stackable and nestable.



Cesto gastronorm, PP
Gastronorm basket, PP
Gastronorm-Korb, PP
Panier gastronorme, PP
Cesta gastronorm, PP

art.	dim. cm.	h.
44034-11	59x39	19,5

Impilabile. - Stackable.



Cesta pane impilabile, polietilene
Bread basket, stackable, LLDPE
Brot-Korb, stapelbar, LLDPE
Corbeille à pain, empilable, LLDPE
Cesta pan, apilable, LLDPE

art.	dim. cm.	h.	lt.
44982-04	57x36	34	40
44982-06	66x45	35	60
44982-10	78x52	40	100



Cesta sovrapponibile, polipropilene
Basket, stackable, PP
Korb, stapelbar, PP
Panier, empilable, PP
Contenedor apilable, PP

art.	dim. cm.	h.	lt.
41761-06	65x43	6,5	13
41761-07	65x43	8,0	20
41761-10	65x43	12,0	26



Coperchio, polipropilene
PP lid
Deckel, PP
Couvercle en PP
Tapa en PP

art.	dim. cm.	h.
41761-00	67x45	2



Contenitori sovrapponibili con dimensioni esterne di mm 600 x 400 e 400 x 300 perfettamente pallettizzabili su pallett EUR mm 800 x 1200 e 1000 x 1200. Disponibili in diverse altezze e versioni. Polietilene alta densità HDPE. Uno dei materiali termoplastici più dotato di resistenza all'impatto con basse temperature (da -30°C a +70°C).

Stackable containers, external dimensions 600 x 400 mm and 400 x 300 mm, they perfectly fit to 800 x 1200 mm EUR pallets and to 1000 x 1200 mm. Available in different heights and versions. High density polyethylene HDPE. A thermoplastic that offers excellent impact resistance at low temperatures (from -30°C to +70°C).



Contenitore sovrapponibile, HDPE
Stackable container, HDPE
Behälter, stapelbar, HDPE
Conteneur empilable, HDPE
Contenedor apilable, HDPE

art.	dim. cm.	h.	lt.
44511E21	60x40	10	21
44511E63	60x40	32	63
44511E90	60x40	45	90

Fondo e pareti chiuse.
Solid bottom and sides.



Contenitore sovrapponibile, HDPE
Stackable container, HDPE
Behälter, stapelbar, HDPE
Conteneur empilable, HDPE
Contenedor apilable, HDPE

art.	dim. cm.	h.	lt.
44512E12	60x40	7	12
44512E21	60x40	10	21

Fondo chiuso e pareti forate.
Solid bottom and perforated sides.



Contenitore sovrapponibile, HDPE
Stackable container, HDPE
Behälter, stapelbar, HDPE
Conteneur empilable, HDPE
Contenedor apilable, HDPE

art.	dim. cm.	h.	lt.
44513E12	60x40	7	12
44513E21	60x40	10	21

Fondo e pareti forate.
All perforated.



Coperchio, polipropilene
Lid, PP
Deckel, PP
Couvercle, PP
Tapa, PP

art.	dim. cm.	h.
41763-00	60x40	2



Coperchio, polipropilene
Lid, PP
Deckel, PP
Couvercle, PP
Tapa, PP

art.	dim. cm.	h.
41763-30	40x30	2



Contenitore sovrapponibile, HDPE
Stackable container, HDPE
Behälter, stapelbar, HDPE
Conteneur empilable, HDPE
Contenedor apilable, HDPE

art.	dim. cm.	h.	lt.
44521E10	40x30	12	10

Fondo e pareti chiuse.
Solid bottom and sides.



Contenitore sovrapponibile, HDPE
Stackable container, HDPE
Behälter, stapelbar, HDPE
Conteneur empilable, HDPE
Contenedor apilable, HDPE

art.	dim. cm.	h.	lt.
44521-16	40x30	17	16
44521-21	40x30	22	21
44521-31	40x30	32	31

Fondo e pareti chiuse.
Solid bottom and sides.



Contenitore sovrapponibile, HDPE
Stackable container, HDPE
Behälter, stapelbar, HDPE
Conteneur empilable, HDPE
Contenedor apilable, HDPE

art.	dim. cm.	h.	lt.
44511-27	60x40	15	27
44511-34	60x40	17	34
44511-38	60x40	20	38
44511-42	60x40	22	42
44511-63	60x40	32	63
44511-90	60x40	45	90

Fondo e pareti chiuse.
Solid bottom and sides.



Contenitore sovrapponibile, HDPE
Stackable container, HDPE
Behälter, stapelbar, HDPE
Conteneur empilable, HDPE
Contenedor apilable, HDPE

art.	dim. cm.	h.	lt.
44522E10	40x30	12	10

Fondo chiuso e pareti forate.
Solid bottom and perforated sides.



Contenitore sovrapponibile, HDPE
Stackable container, HDPE
Behälter, stapelbar, HDPE
Conteneur empilable, HDPE
Contenedor apilable, HDPE

art.	dim. cm.	h.	lt.
44522-16	40x30	17	16
44522-21	40x30	22	21
44522-31	40x30	32	31

Fondo chiuso e pareti forate.
Solid bottom and perforated sides.



Contenitore sovrapponibile, HDPE
Stackable container, HDPE
Behälter, stapelbar, HDPE
Conteneur empilable, HDPE
Contenedor apilable, HDPE

art.	dim. cm.	h.	lt.
44512-34	60x40	17	34
44512-42	60x40	22	42
44512-63	60x40	32	63
44512-90	60x40	45	90

Fondo chiuso e pareti forate.
Solid bottom and perforated sides.



Contenitore sovrapponibile, HDPE
Stackable container, HDPE
Behälter, stapelbar, HDPE
Conteneur empilable, HDPE
Contenedor apilable, HDPE

art.	dim. cm.	h.	lt.
44513-34	60x40	17	34
44513-38	60x40	20	38
44513-54	60x40	29	54
44513-63	60x40	32	63
44513-90	60x40	45	90

Fondo e pareti forate.
All perforated.

Il polipropilene è un materiale idoneo per il contatto con sostanze alimentari. Non cede odori e sapori anomali agli alimenti ed è facilmente lavabile e sanificabile dopo il suo utilizzo. I contenitori isotermici sono ideali per proteggere gli alimenti da sollecitazioni di tipo meccanico grazie allo spessore ed alla struttura a cellula chiusa; sono leggeri e privi di sporgenze e spigoli vivi per tutelare la sicurezza degli operatori durante le operazioni di movimentazione e trasporto. Resistenti, igienici, ecologici e riciclabili al 100%, sono compatibili al lavaggio e alla disinfezione industriale con detergenti e disinfettanti, acqua calda e vapore umido fino alla temperatura di 110°C (HACCP System). Sono idonei a proteggere gli alimenti da sollecitazioni termiche grazie alle proprietà coibenti del polimero espanso il quale possiede un coefficiente di resistività (Lambda) di 0,039 W/mk e garantisce una caduta termica di 1,5-2,5°C/H/contenitore.

The polypropylene is certified as material suitable for contact with food. It does not hand over odours or flavours to foods and it is easy to wash and disinfect after use. The isothermal containers, entirely made of closed-cell expanded polypropylene, are ideal to protect food from mechanical stresses; they are light and free of protrusions and sharp edges in order to guarantee the operators' safety during handling and transport operations. They are resistant, hygienic, economic, 100% recyclable, suitable for industrial washing and disinfection with detergents and disinfectants, hot water, and wet vapour up to a temperature of 110°C (HACCP System). These containers are suitable to protect food thermal stresses thanks to the insulating properties of the expanded polymer which has a resistivity coefficient (Lambda) of 0.039 W/mk and guarantees a thermal loss of 1.5-2.5°C/H/container.

CURVA DELLA TEMPERATURA
TEMPERATURE CURVE

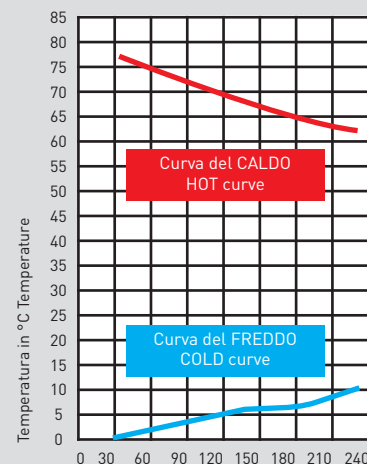

Contenitore isotermico GN 1/2
Insulated box 1/2 GN
GN 1/2-Thermobehälter
Conteneur isotherme GN 1/2
Contenedor isotérmico GN 1/2

art.	cm. ext.	cm. int.
44972-20	41,5x32x28,5	35x27x21,5
44972-25	41,5x32x32	35x27x25
44972-33	41,5x32x40	35x27x33



+ OPTIONAL

44980-60

DOLLY

Contenitore isotermico GN 1/1
Insulated box 1/1 GN
GN 1/1-Thermobehälter
Conteneur isotherme GN 1/1
Contenedor isotérmico GN 1/1

art.	cm. ext.	cm. int.
44970-10	60x40x17	54x34x11
44970-15	60x40x23	54x34x17
44970-20	60x40x27	54x34x21
44970-34	60x40x34,5	54x34x28

44973-10 SLING
44973-20 SLING



Imbracatura elastica GN 1/1
Resilient sling GN 1/1
Gummi-Schleppgurt GN 1/1
Elingue élastique GN 1/1
Cinta elástica GN 1/1

art.	per articolo/for item
44973-10	44970-10/44970-15
44973-20	44970-20/44970-34



Contenitore isotermico PLUS GN 1/1
Insulated box
Thermobehälter
Conteneur isotherme
Contenedor isotérmico

art.	cm. ext.	cm. int.
44978-10	68x44,5x20	56x37x12
44978-20	68x44,5x30	56x37x22



Contenitore isotermico UNIVERSAL PN
Insulated container
Thermobehälter
Conteneur isotherme
Contenedor isotérmico

art.	cm. ext.	cm. int.
44986-12	61x43x20	54,5x36,5x12
44986-17	61x43x25	54,5x36,5x17
44986-21	61x43x29,5	54,5x36,5x21,5
44986-28	61x43x36,5	54,5x36,5x28,5



Contenitore isotermico per pasticceria
Insulated pastry box
Konditorei-Thermobehälter
Conteneur isotherme à pâtisserie
Contenedor isotérmico

art.	cm. ext.	cm. int.
44974-21	68,5x48,5x27	62,5x42,2x21
44974-27	68,5x48,5x33	62,5x42,2x27
44974-31	68,5x48,5x37	62,5x42,2x31



+ OPTIONAL
44979-05
44979-02
44979-11
**COLD
HOT
GEL**

Contenitore isotermico CARGO-BOX
Insulated container
Thermobehälter
Conteneur isotherme
Contenedor isotérmico

art.	cm. ext.	cm. int.
44985-00	80x60x52	68x46,5x38

Il contenitore extra resistente conforme Europallet ed Euroroll. - *The extra strong box that complies with Europallet and Euroroll standards.*



+ OPTIONAL
44979-05
44979-02
**COLD
HOT**

Contenitore isotermico PORTER MINI
Insulated container
Thermobehälter
Conteneur isotherme
Contenedor isotérmico

art.	cm. ext.	cm. int.
44969-00	60,5x40,6x37,6	54x34x26,7

Il contenitore isotermico leggero e funzionale ad apertura frontale. 1 guida. *The light and functional front loading isothermal box. 1 guide.*



Contenitore isotermico PORTER MINI ACTIV
Insulated container
Thermobehälter
Conteneur isotherme
Contenedor isotérmico

art.	cm. ext.	cm. int.
44969-01	60,5x40,6x37,6	54x34x26,7

Con sistema di riscaldamento elettrico per il mantenimento termico. 1 guida. *With electric heating system for heat-maintaining. 1 guide.*
230V - 50/60HZ - 80W - IP64 - 90°C



+ OPTIONAL
44979-05
44979-02
44987C11
**COLD
HOT
DOLLY**

Contenitore isotermico PORTER GN 1/1
Insulated box GN 1/1
GN 1/1 Thermobehälter
Conteneur isotherme GN 1/1
Contenedor isotérmico GN 1/1

art.	cm. ext.	cm. int.
44987-11	65x50x61	54x33x48

Per GN 1/1 o sottomultipli. 12 guide. *For GN 1/1 or submultiples. 12 guides.*



Contenitore isotermico PORTER ACTIV
Insulated container
Thermobehälter
Conteneur isotherme
Contenedor isotérmico

art.	cm. ext.	cm. int.
44987-12	65x50x61	54x33x48

Con sistema di riscaldamento elettrico per il mantenimento termico. 12 guide. *With electric heating system for heat-maintaining. 12 guides.*
230V - 50/60HZ - 110W - IP64 - 90°C



+ OPTIONAL
44979-06
44979-03
44987C60
**COLD
HOT
DOLLY**

Contenitore isotermico PORTER MAXI
Insulated box
Thermobehälter
Conteneur isotherme
Contenedor isotérmico

art.	cm. ext.	cm. int.
44987-60	72x60x63	60x40x50

9 guide. - *9 guides.*



Contenitore isotermico GN CRYSTAL®
Insulated container
Thermobehälter
Conteneur isotherme
Contenedor isotérmico

art.	cm. ext.	cm. int.
44968-00	60x40x30	54x34x24

+ OPTIONAL

44979-02
44968-01
44968-02
44968-03
44968-04
44967C62

**SLING
ORANGE LID
LEMON LID
GREEN LID
MAGENTA LID
DOLLY**



Robusto e leggero con interno cristallizzato perfettamente liscio, rigido e impermeabile. - *Strong and light, inside crystallized and therefore perfectly smooth, rigid and waterproof.*

per/for art.: 44970-10-15-20-34
Range: -18°C / +75°C.



Eutettico HOT
Eutectic pad
Kühlakkus
Cartouche eutectique
Placas eutécticas

Eutettico COLD
Eutectic pad
Kühlakkus
Cartouche eutectique
Placas eutécticas

Gel per la termostatazione
Heat temperature regulation gel
Wärme Temperaturregelungs-Gel
Gel pour le contrôle thermique
Gel para la termostatación

art.	dim. cm.	°C	GN
44979-01	32,5x26,5x3	0/+85	1/2
44979-02	53x32,5x3	0/+85	1/1
44979-03	60x40x3	0/+85	

art.	dim. cm.	°C	GN
44979-04	32,5x26,5x3	0/-21	1/2
44979-05	53x32,5x3	0/-21	1/1
44979-06	60x40x3	0/-21	

art.	dim. cm.	h.	
44979-11	53x32,5	2,0	GN 1/1
44979-12	20x10	2,0	Kg. 1
44979-13	15x10	1,5	gr. 500
44979-14	10x10	1,0	gr. 250

Alta efficienza termica.
High thermal efficiency.



Inserto per eutettici HOT & COLD
Insert for HOT & COLD eutectic pads
Einsatz für HOT & COLD Kühlakkus
Elément pour cartouches eutectiques
Elemento para placas eutécticas

Carrello, ABS
Dolly, ABS
Fahrgestell, ABS
Chariot, ABS
Carretilla, ABS

art.	dim. cm.	h.	GN	
44971-01	42x33	8,5	1/2	Per/for art.: 44972-20-25-33
44971-02	60,5x40,5	11,0	1/1	Per/for art.: 44970-10-20-15-34
44971-03	61,5x43	11,5	UNIVERSAL	Per/for art.: 44986-12-17-21-28

art.	dim. cm.	h.	carico/load
44980-60	61x41	12	kg. 180/200

per/for art.: 44970-10-15-20-34



Inserto per eutettici HOT & COLD
Insert for HOT & COLD eutectic pads
Einsatz für HOT & COLD Kühlakkus
Elément pour cartouches eutectiques
Elemento para placas eutécticas

Carrello inox
Dolly, stainless steel
Fahrgestell, Edelstahl Rostfrei
Chariot inox
Carro inox

art.	dim. cm.	h.	GN	
44971-04	68,5x45	11	PLUS	Per/for art.: 44978-10-20
44971-05	69,5x49,5	10	MAXI	Per/for art.: 44974-21-27-31

art.	dim. cm.	per/for
44975C50	51x51	44975-50
44987C11	61x51	44987-11
44987C60	69x59	44987-60

STOCCAGGIO E TRASPORTO STORAGE & TRANSPORT



BASE E COPERCHIO
BASE AND LID
44975-35



ESTENSORE
EXTENDER
44975H35



BASE E COPERCHIO
BASE AND LID
44975-35

Contenitore isotermico **PIZZA**
Insulated container
Thermobehälter
Conteneur isotherme
Contenedor isotérmico

art.	cm. ext.	cm. int.	
44975-35	41x41x7,5	35x35x7,5	Base e coperchio/Base and lid
44975H35	41x41x7,5	35x35x4,5	Estensore/Extender



BASE E COPERCHIO
BASE AND LID
44975-50



ESTENSORE
EXTENDER
44975H50



BASE E COPERCHIO
BASE AND LID
44975-50

Contenitore isotermico **PIZZA**
Insulated container
Thermobehälter
Conteneur isotherme
Contenedor isotérmico

art.	cm. ext.	cm. int.	
44975-50	57x57x10,5	51x51x10,5	Base e coperchio/Base and lid
44975H50	57x57x10,5	51x51x6,3	Estensore/Extender



Box isotermico 2 vani
Insulated box, 2 compartments
2-Abteilung-Thermobehälter
Conteneur isotherme, 2 compartiments
Contenedor individual isotérmico

art.	dim. cm.	dim. int.
44976-02	42,5x26,5x16,5	38x22x12

Due vani indipendenti, per piattini in PP 18x18 cm. - *Two separate sections for polypropylene dishes size 18x18 cm.*



Box isotermico Monoking
Insulated Monoking box
Monoking-Thermobehälter
Conteneur isotherme Monoking
Contenedor individual isotérmico

art.	dim. cm.	dim. int.
44976-01	42,5x35x16	42x29x12

Due vani coibentati per piattini in PP 18x18 cm. - *With two insulated sections for polypropylene dishes size 18x18 cm.*



Box isotermico Thermoking
Insulated Thermoking box
Thermoking-Thermobehälter
Conteneur isotherme Thermoking
Contenedor individual isotérmico

art.	dim. cm.	dim. int.
44976-03	47x37x18,5	40x30x11,5

Coperchio a incastro. L'altezza utile interna (11,5 cm) permette di alloggiare 3 piatti per vano. - *With release latch lid. Each section (h 11,5 cm) enables to storage 3 dishes.*

Il sistema modulare dove base e coperchio sono lo stesso elemento e grazie all'inserto estensore è possibile aumentare la capacità. - *The modular system where the base and lid are the same element and due to the extender insert it is possible to increase capacity.*

PIZZA FAMILY 50 X 50 CM

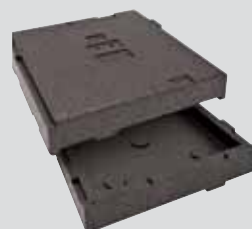

PIZZA SINGLE 35 X 35 CM

DOLCISSIMA 35 X 35 CM - 50 X 50 CM

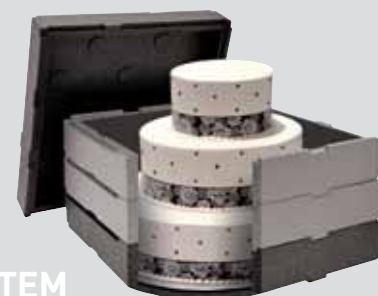

FINGER FOOD SYSTEM 50 X 50 CM



NO LIMITS

Aumenta la capacità - sovrapposizione base/coperchio - con estensione.
Increases capacity - overlapping base/lid - with extender insert.



Box isotermico Domus
Insulated Domus box
Domus-Thermobehälter
Conteneur isotherme Domus
Contenedor individual isotérmico

art.	dim. cm.	dim. int.
44976-04	44x38x12	40x34x90

Tre vani indipendenti. Ogni vano può alloggiare piattini di ø 12 cm., h 6 cm., o da 16x16 cm. Disponibile imbracatura elastica art. 44973-04. *Three separate sections for dishes ø 12 cm., h 6 cm. or size 16x16 cm. Available sling item: 44973-04.*

Box isotermico Dinner Box
Insulated Dinner box
Dinner Box-Thermobehälter
Conteneur isotherme Dinner box
Contenedor individual isotérmico



art.	dim. cm.	h.
44976-05	24x25	35

3 vani coibentati. Pratica maniglia e nuova apertura frontale.
3 compartments. Practical handle and new front opening.

Pietanziera, inox
Food container, stainless steel
Speisenbehälter, 18-10 Edelstahl
Porte-manger, inox
Contenedor comida, inox

art.	ø cm.	h.
44977-12	12	6



Contenitore isotermico, inox AISI 304
Insulated container, stainless steel
Thermobehälter, Edelstahl Rostfrei
Conteneur isotherme, inox
Contenedor isotérmico, inox

art.	ø cm.	h.	lt.	kg.
44505-05	30	17,0	5	3
44505-10	30	22,5	10	4
44505-15	36	21,5	15	5
44505-20	36	28,5	20	6
44505-25	36	35,0	25	7



1. Impilabile.
2. Impugnature ergonomiche.
3. Coperchio a chiusura ermetica.
4. Valvola di sfiato per evitare l'effetto sottovuoto.
5. Guarnizioni in gomma vulcanizzata.
6. Realizzazione a doppia parete.
7. Rubinetto h. 11 cm.

1. Stackable.
2. Ergonomic handles.
3. Tight-fitting lid.
4. Vent valve to prevent vacuum effect.
5. Vulcanized rubber gaskets.
6. Double-wall construction.
7. Tap height 11 cm.



Contenitore isotermico GN 1/1
Insulated container GN 1/1
Thermobehälter GN 1/1
Conteneur isotherme GN 1/1
Contenedor isotérmico GN 1/1

art.	ø cm.	h.	lt.	kg.
44506-05	30	28	5	5
44506-09	30	34	9	6

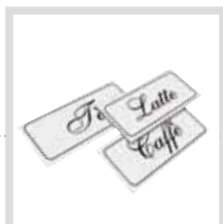
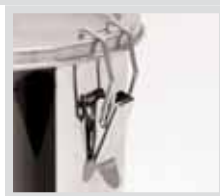

Spazzolino per la pulizia e serie di etichette Latte, Caffè e Tè in 5 lingue incluse nella confezione.

Included into the package cleaning brush and labels set Milk, Coffee and Tea in 5 languages.

Per 3 GN 1/1 h. 20 cm. 50-70 pasti.
For 3 pans GN 1/1 h. 20 cm. 50-70 meals.



Per 2 GN 1/1 h. 20 cm. 35-50 pasti.
For 2 pans GN 1/1 h. 20 cm. 35-50 meals.



Carrello termico GN 3/1
Thermic wagon GN 3/1
Wärmewagen GN 3/1
Chariot thermique GN 3/1
Carro térmico GN 3/1

Carrello termico GN 2/1
Thermic wagon GN 2/1
Wärmewagen GN 2/1
Chariot thermique GN 2/1
Carro térmico GN 2/1

Contenitore isotermico, PE
Insulated carrier, PE
Isolierte-Thermobehälter, PE
Conteneur isotherme, PE
Contenedor isotérmico, PE



art.	dim. cm.	V	KW	art.	dim. cm.	V	KW
44802-31	116x67x86	230	2	44802-21	84x67x86	230	2

art.	dim. cm.	h.	lt.
44935-01	47,6x67,9	70,5	89
44935-02	47,6x67,9	85,4	89

In acciaio inox, con riscaldamento a bagno maria. Vasca coibentata, dotata di rubinetto di scarico. Termostato analogico 0-90°C, spia di accensione, termostato di sicurezza. 4 ruote pivotanti di cui 2 con freno. Forniti senza vasche GN, da ordinarsi separatamente. - *Stainless steel construction. Insulated tank with drain cock. Analogical thermostat 0-90°C, pilot light, safety thermostat. 4 swivel casters, 2 with brakes. Supplied without GN pans, to be ordered separately.*

Per 6 GN 1/1 o sottomultipli, h. 65 mm.
For 6 GN 1/1 or submultiples, h. 65 mm.



Contenitore isotermico GN 1/1
Insulated container GN 1/1
Thermobehälter GN 1/1
Conteneur isotherme GN 1/1
Contenedor isotérmico GN 1/1

Contenitore isotermico GN 1/1
Insulated container GN 1/1
Thermobehälter GN 1/1
Conteneur isotherme GN 1/1
Contenedor isotérmico GN 1/1

Distributore di bevande isotermico
Insulated beverage dispenser
Isolierte Getränkebehälter
Conteneur isotherme avec robinet
Contenedor isotérmico con grifo

art.	dim. cm.	lt	kg	art.	dim. cm.	lt	kg
44932-15	61x41x25	24,6	5,9	44934-30	44x64x48	63	11,5
44932-20	61x41x30	31,1	5,9				

art.	dim. cm.	lt	kg
44930-10	24x43x43	10	4,6
44930-20	30x46x46	20	6,0

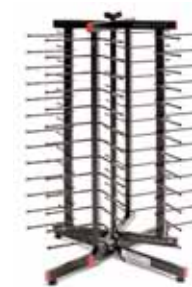
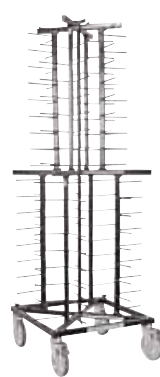

Carrello porta piatti, 104 pz.
Mobile plate rack, 104 pcs
Fahrbares Tellergestell, 104 Stk.
Chariot porte-assiettes mobile, 104 pcs
Carrito para almacenaje de platos, 104 pz

Carrello porta piatti
Mobile plate rack
Fahrbares Tellergestell
Chariot porte-assiettes mobile
Carrito para almacenaje de platos

Porta piatti rotante
Swivelling table top rack
Drehbares Tischgestell
Porte-assiettes de table pivotant
Soporte para almacenaje de platos

art.	dim. cm.	h.	kg.	art.	dim. cm.	h.	kg.
44830-99	60x60	179	30	44830-72	60x60	179	28

art.	dim. cm.	h.	kg.
44831-52	48x48	89	13

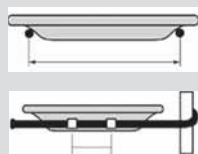

JACKSTACK. Struttura in acciaio saldato. Rivestimento nero elettrostatico. Assemblaggio veloce. Adattabile ad ogni misura di piatto (ø max cm 30, kg 3 cad.). Lunghezza bracci 17 cm, distanza 5 cm. *Welded steel construction. Black electrostatic powder coating. Quick set assembly in minutes. Quick-change to any plate size (max ø cm 30, kg 3 each). Length of plate support 17 cm, spacing 5 cm.*



Copertura in plastica
Zippered plastic cover
Plastik Schutzhülle
Housse en plastique
Cubrecarrito, plástico

art.	per/for item #
44832-52	44830-52 & 44831-52
44832-99	44830-72 & 44830-99



Copertura termica
Thermo cover
Thermo-Hülle
Thermo-housse
Cubrecarrito, térmico

art.	per/for item #
44833-52	44830-52 & 44831-52
44833-99	44830-72 & 44830-99

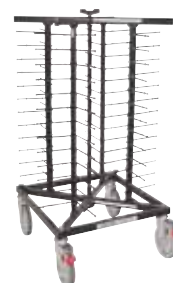

Carrello porta piatti
Mobile plate rack
Fahrbares Tellergestell
Chariot porte-assiettes mobile
Carrito para almacenaje de platos

art.	dim. cm.	h.	kg.
44830-52	60x60	103	22



Box termico, inox
Thermic box, stainless steel
Speisen-Kaste, Edlsthil Rostfrei
Caisson thermique, inox
Cajón isotérmico, inox

art.	dim. cm.	h.	Volt/Watt
44094-00	38x45	52	230/500

Termostato analogico 0-90°C, spia di accensione, termostato di sicurezza, cavo asportabile da 2 mt. - *Analogical thermostat 0-90°C, pilot light, safety thermostat, removable cable lenght 2 mt.*



Carrello room-service
Room-service trolley
Room-Service-Wagen
Chariot room-service
Carro room-service

art.	dim. cm.	h.
44094-01	90x55	77

Struttura tubolare cromata, piano laminato noce, 2 ruote con freno. - *Tube chromed structure, laminated top in walnut color, 2 casters with brakes.*



Carrello con box termico
Trolley with thermic box
Wagen mit Speisen-Kaste
Chariot avec caisson thermique
Carro con cajón isotérmico

art.	ø cm.	h.	Volt/Watt
44094-02	90	77	230/500

(44094-00 + 44094-01)



Carrello room-service
Room-service trolley
Room-Service-Wagen
Chariot room-service
Carro room-service

art.	dim. cm.	h.
44094-03	ø90	77
Chiuso-Closed	55x63	118



Carrello con box termico
Trolley with thermic box
Wagen mit Speisen-Kaste
Chariot avec caisson thermique
Carro con cajón isotérmico

art.	ø cm.	h.	Volt/Watt
44094-04	90	77	230/500
(44094-00 + 44094-03)			



Carrello room-service
Room-service trolley
Room-Service-Wagen
Chariot room-service
Carro room-service

art.	dim. cm.	h.
44094-05	ø90	78
Chiuso-Closed	90x26	98



Carrello con box termico
Trolley with thermic box
Wagen mit Speisen-Kaste
Chariot avec caisson thermique
Carro con cajón isotérmico

art.	ø cm.	h.	Volt/Watt
44094-06	90	78	230/500
[44094-00 + 44094-05]			



Coperture monouso, 200 pezzi
Disposable covers, 200 pcs
Einweg-Schutzhüllen, 200 Stk.
Housses usage unique, 200 pcs
Cubrecarritos desechables, 200 pz

art.	per/for	h.
42512-91	GN 1/1	180
42512-92	GN 2/1 60x40	180



Porta rotolo, inox
Roll holder, stainless steel
Rollenhalter, Edelstahl Rostfrei
Dérouleur mural, inox
Portarollos, inox



art.	dim. cm.	h.	kg.
42512-90	90x23	19	1,5



Carrello GN 2/1, inox
Utility rack GN 2/1, stainless steel
2/1 GN-Behälterwagen, E. R.
Chariot GN 2/1, inox
Carro GN 2/1, inox

art.	dim. cm.	h.
44807-28	60x70	153,5

Struttura saldata, 28 guide, 4 ruote girevoli di cui 2 con freno. - *Welded structure, 28 rails, 4 wheels, 2 with brakes.*



18 GN 2/1
36 GN 1/1

Carrello GN 2/1, inox
Utility rack GN 2/1, stainless steel
2/1 GN-Behälterwagen, E. R.
Chariot GN 2/1, inox
Carro GN 2/1, inox

art.	dim. cm.	h.
44807-36	73x62	171

Fornito smontato, 18 guide, accoglie GN di h. 65 mm. Carico max 300 kg. - *To be assembled, 18 rails, accomodates GN pans height 65 mm. Load max 300 kg.*



9 GN 2/1
18 GN 1/1

Carrello GN 1/1, inox
Utility rack GN 1/1, stainless steel
1/1 GN-Behälterwagen, E. R.
Chariot GN 1/1, inox
Carro GN 1/1, inox

art.	dim. cm.	h.
44807-18	38x62	164

Fornito smontato, 18 guide, accoglie GN di h. 65 mm. Carico max 150 kg. - *To be assembled, 18 rails, accomodates GN pans height 65 mm. Load max 150 kg.*



Carrello GN 1/1, inox
Utility rack GN 1/1, stainless steel
1/1 GN-Behälterwagen, E. R.
Chariot GN 1/1, inox
Carro GN 1/1, inox

art.	dim. cm.	h.
44801-09	38x62	94,5

Fornito smontato, 9 guide, accoglie GN di h. 65 mm. Carico max 75 kg. - *To be assembled, 9 rails, accomodates GN pans height 65 mm. Load max 75 kg.*



Carrello GN 2/1, inox
Utility rack GN 2/1, stainless steel
2/1 GN-Behälterwagen, E. R.
Chariot GN 2/1, inox
Carro GN 2/1, inox

art.	dim. cm.	h.
44801-18	73x62	94,5

Fornito smontato, 9 guide, accoglie GN di h. 65 mm. Carico max 150 kg. - *To be assembled, 9 rails, accomodates GN pans height 65 mm. Load max 150 kg.*



Carrello porta teglie, inox
Baking sheet trolley, stainless steel
Backbleche-Wagen, Edelstahl Rostfrei
Chariot pour plaques, inox
Carro porta placas, inox

art.	dim. cm.	h. cm.
44826-08	53x67	89

Struttura saldata, 8 guide per teglie 60x40 cm, distanza guide 7,5 cm, 2 ruote con freno. - *Welded structure, 8 rails for baking sheets 60x40, height clearance 7,5 cm, 2 wheels with brakes.*



Carrello porta teglie, inox
Baking sheet trolley, stainless steel
Backbleche-Wagen, Edelstahl Rostfrei
Chariot pour plaques, inox
Carro porta placas, inox

art. dim. cm. h. carico/load
44826-20 69x49 187 kg.100

20 guide per teglie cm 60x40, distanza guide 8 cm. - 20 rails for baking sheets cm 60x40, height clearance 8 cm.



Carrello porta teglie, zincato
Baking sheet trolley, galvanized steel
Backbleche-Wagen, verzinkt
Chariot pour plaques, galvanisé
Carro porta placas, galvanizado

art. dim. cm. h. carico/load
44825-20 51x50 170 kg. 80

20 guide, distanza guide 8 cm.
20 rails, height clearance 8 cm.



Carrello porta teglie, zincato
Baking sheet trolley, galvanized steel
Backbleche-Wagen, verzinkt
Chariot pour plaques, galvanisé
Carro porta placas, galvanizado

art. dim. cm. h. carico/load
44825-40 51x75 170 kg. 160

40 guide, distanza guide 8 cm.
40 rails, height clearance 8 cm.



Fornito smontato. 5 piani di cui 3 regolabili. Fornito con sacco PVC ribaltabile dotato di coperchio. Bordo paracolpi in gomma anti-traccia. Struttura in metallo verniciata grigia, pannelli laterali in laminato. 2 ruote con freno. Portata max 250 kg equamente distribuiti. - To be assembled. 5 shelves, 3 of them adjustable. Supplied with tip-up holder for PVC bag with lid. Non marking shock-proof rubber bumper. Metal structure, grey enamelled, laminated side walls. 2 wheels with brake. Max load kg 250 evenly distributed.

Carrello servizio
Service trolley
Servierwagen
Chariot de service
Carro de servicio

art. dim. cm. h.
44095-06 85x57 131
44095-07 105x57 131



Carrello di servizio, inox
Serving trolley, stainless steel
Mehrzweckwagen, Edelstahl Rostfrei
Chariot de service, inox
Carrito para desocupar, inox

art. dim. cm. h.
44820-80 80x50 93,5
44820-99 100x50 93,5

Fornito smontato, 4 ruote girevoli di cui 2 con freno. Portata max. per ripiano kg 30. To be assembled, 4 swivel castors, 2 with brakes. Max load per shelf kg 30.



Carrello di servizio, inox
Serving trolley, stainless steel
Mehrzweckwagen, Edelstahl Rostfrei
Chariot de service, inox
Carrito para desocupar, inox

art. dim. cm. h. carico/load
44819-02 91x59 93 kg. 80

Fornito smontato, 4 ruote girevoli di cui 2 con freno. - To be assembled, 4 swivel castors, 2 with brakes.



Carrello servizio, inox
Service trolley, stainless steel
Servierwagen, Edelstahl Rostfrei
Chariot de service, inox
Carro de servicio, inox

art. dim. cm. h.
44095-05 83x53 135

Fornito smontato. Con sacco in PVC, 2 ruote con freno. - To be assembled. Equipped with PVC bag and 2 wheels with brake.



Carrello di servizio, inox
Serving trolley, stainless steel
Mehrzweckwagen, Edelstahl Rostfrei
Chariot de service, inox
Carrito para desocupar, inox

art. dim. cm. h.
44822-80 80x50 93,5
44822-99 100x50 93,5

Fornito smontato, 4 ruote girevoli di cui 2 con freno. Portata max. per ripiano kg 30. To be assembled, 4 swivel castors, 2 with brakes. Max load per shelf kg 30.



Carrello di servizio, inox
Serving trolley, stainless steel
Mehrzweckwagen, Edelstahl Rostfrei
Chariot de service, inox
Carrito para desocupar, inox

art. dim. cm. h. carico/load
44819-03 91x59 93 kg. 120

Fornito smontato, 4 ruote girevoli di cui 2 con freno. - To be assembled, 4 swivel castors, 2 with brakes.



Carrello 3 ripiani, PP
3-shelf cart, PP
Mehrzweckwagen mit 3 Etagen, PP
Chariot de service, 3 plateaux, PP
Carrito para desocupar, 3 niveles, PP

art.	dim. cm.	h.	kg.
44030-03	42x71	90	11,5

Supporti in alluminio tubolare, facile da montare. Flessibilità nel posizionamento dei maniglioni. - *Tubular aluminum supports, quick to assemble. Flexibility of positioning the handles.*



Cesti e contenitori, PP
Bins and containers, PP
Kasten und Körbe, PP
Réceptifs et containers, PP
Cubos y contenedores, PP

art.	dim. cm.	h.	kg.
44033B23	66x45	23,0	2,10
44031-04	52x39	12,7	0,75
44031-05	52x39	17,7	0,92



Contenitore, PE-HD
Container, PE-HD
Kaste, PE-HD
Réceptif, PE-HD
Contenedor, PE-HD

art.	dim. cm.	h.	kg.
44031-01	33,7x23	56,0	2,10
44031-02	33,7x23	18,7	0,85



Carrello di servizio, PP
Serving trolley, PP
Mehrzweckwagen, PP
Chariot de service, PP
Carrito para desocupar, PP



art.	dim. cm.	h.
49995-04	97x51	99

Maniglie ergonomiche arrotondate, pannelli laterali e bordo paraurti arrotondato. Portata 135 kg [45 kg per ripiano]. Ruote girevoli, antitraccia e silenziose. Colore nero. - *Swivel casters for easy manoeuvrability. Ergonomic handles, high load capacity [45 kg per shelf]. Ultra-quiet mark-resistant casters. Black color.*



Carrello portavassoi, filo cromato
Tray serving trolley, chromed wire
Tablettwagen, Metall verchromt
Chariot de service plateaux, chromé
Carrito para bandejas, cromado

art.	dim. cm.	h.	kg.
44094-20	60,5x40	99	7,5



VASSOI VEDI PAGINA 335
TRAYS SEE PAGE 335



Ideale per il servizio di mini colazioni.
Ideal for quick breakfast service.
Per vassoi/for trays: cm. 46x36



Carrello per rifornimento frigobar
Trolley for restocking refrigerators
Wagen für Versorgung der Kühlschränken
Chariot pour approvisionner les frigo-bar
Carro de servicio frigobar

art.	dim. cm.	h.	carico/load
44095-03	105x54	119	kg.250

Metallo verniciato grigio, 3 cassetti estraibili, chiusura con serratura, 4 ruote pivotanti di cui 2 con freno. - Structure in grey enamelled metal, 4 drawers, doors with lock, 4 swivel casters, 2 with brakes.



Carrello per rifornimento frigobar
Trolley for restocking refrigerators
Wagen für Versorgung der Kühlschränken
Chariot pour approvisionner les frigo-bar
Carro de servicio frigobar

art.	dim. cm.	h.	carico/load
44095-04	85x54	132	kg.250

Legno laminato, 3 cassetti estraibili, chiusura con serratura, 4 ruote pivotanti di cui 2 con freno. - Laminated wood structure, 3 drawers, doors with lock, 4 swivel casters, 2 with brakes.



Carrello per rifornimento frigobar
Trolley for restocking refrigerators
Wagen für Versorgung der Kühlschränken
Chariot pour approvisionner les frigo-bar
Carro de servicio frigobar

art.	dim. cm.	h.	carico/load
44095-01	82x53	112	kg.150

Struttura tubolare cromata, ripiani laminato noce, 4 ruote pivotanti.
Tube chromed structure, laminated shelves walnut color, 4 swivel castors.



Carrello porta cassette, inox
Dolly for cases, stainless steel
Plattformwagen, Edelstahl Rostfrei
Chariot à caisses, inox
Carretilla de transporte, inox

art.	dim. cm.	h.	carico/load
44026-60	65x45	12	kg. 50

Portata max. 181 kg. Maniglia regolabile in 3 posizioni. Superficie antiscivolo. 2 ruote fisse e 2 pivotanti, antitraccia da 10 cm. - Three position handle ensures optimum handling whatever the load. Non slip deck, non-marking casters, 2 swivel and 2 rigid. Max load capacity kg 181.



Carrello trasporto materiali, PE
Trolley, PE
Plattformwagen, PE
Chariot, PE
Carretilla, PE

art.	dim. cm.	h.
49378-00	82,6x52	98,7

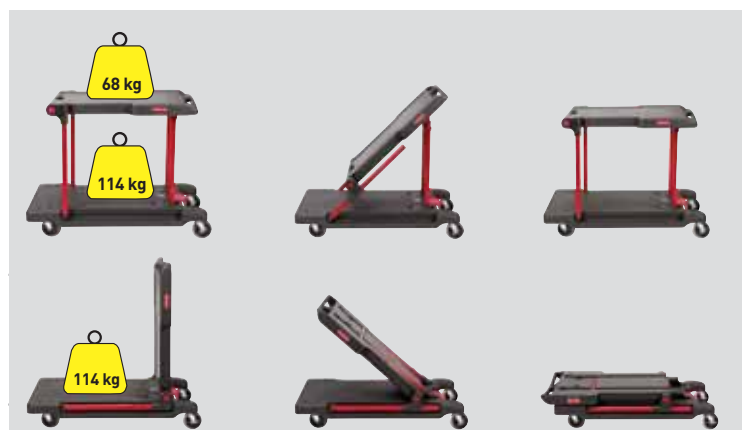

Carrello convertibile, PP
Trolley, PP
Plattformwagen, PP
Chariot, PP
Carretilla, PP

art.	dim. cm.	h.
49379-00	56x53	43,5

Ruote antitraccia di cui 2 fisse e 2 girevoli, ruote posteriori bloccabili. Struttura in PP e metallo verniciato. - Four non-marking casters (two rear locking), 2 swivel and 2 rigid. Structure PP and powder coated metal.

PULIZIA E SICUREZZA *CLEANING & SAFETY*





Carrello di servizio, PP
Housekeeping cart
Servicewagen
Chariot de service
Carro de habitaciones



art.	dim. cm.	h.	lt.
44178-45	124,5x56	127	128

Include 1 sacco con zip in tessuto con fodera in PVC impermeabile, 2 ripiani per biancheria, ruote antitraccia con freno.
Includes 1 bag with waterproof PVC lining and zip, 2 shelves, non-marking wheels with brakes

Carrello di servizio, PP
Housekeeping cart
Servicewagen
Chariot de service
Carro de habitaciones



art.	dim. cm.	h.	lt.
44178-40	131x56	136	2x128

Include bauletto di sicurezza, ante di chiusura con accesso da entrambi i lati. Due sacchi con zip in tessuto con fodera in PVC impermeabile. - *Includes locking security hood and cabinet doors, with access from both sides of cart. Two heavy-duty zipped compact fabric bags with waterproof PVC lining.*



SALVASPAZIO - SPACE SAVING!

6 tasche per inserire attrezzi di pulizia, guanti, strofinacci, spray, prodotti per la pulizia e quant'altro! La copertura rimane saldamente fissata tramite velcro. La coulisse della copertura l'assicura saldamente al telaio pieghevole. - *6 storage pockets hold cleaning tools, gloves, clothes, spray bottles, cleaning chemicals and more! Lid stays secured with strong velcro trim. Drawstring tightly secures cover onto collapsible cart frame.*



Telaio pieghevole, acciaio verniciato
Collapsible frame, powder coated steel
Klappbares Gestell, pulverbeschichtete Stahl
Châssis repliable, acier peint
Carre plegable, acero pintado

art.	dim. cm.	h.	lt.
44178-15	51,6x61,3	83,9	150
44178-16	88,9x61,3	83,9	300

chiuso/closed

44178-15	39x56,9	69,3	150
44178-16	78x56,9	69,3	300

Sacco vinile, nero
Vinyl bag, black
Vinyl-Sack, schwarz
Sac en vinyle, noir
Bolsa de vinilo, negro



art.	dim. cm.	h.	lt.
44178-17	39x56,9	69,3	150
44178-18	78x56,9	69,3	300



Copertura vinile, nero
Vinyl bag cover, black
Vinyl-Sack-deckel, schwarz
Couvercle à sac en vinyle, noir
Tapa para bolsa de vinilo, negro

art.	dim. cm.	h.
44178-19	64,4x50,4	22,8
44178-20	88,9x66,6	22,8

Telaio pieghevole consente uno stoccaggio efficiente. Design compatto e leggero per una maggiore manovrabilità. Sacchi in vinile durevoli, ad alta capacità (100 kg); facili da pulire. Dal colore discreto e silenziosi per un'immagine di alto livello. Copertura: con tasche integrate su ogni lato. Comodo, accesso rapido all'interno del carrello, senza dover rimuovere il coperchio. Telaio rimane pieghevole con o senza copertura. - *Collapsible frame enables efficient storage. Compact, lightweight design for superior manoeuvrability. Durable, high capacity (100 kg) vinyl bag accommodates large loads; easy-to-clean. Discreet color & quiet operation for enhanced image. X-Cart Cover: multiple, built-in storage pockets on each side. Convenient, Quick-Access-Lid provides easy access to contents inside of cart without having to remove cover. Frame remains collapsible with or without cover.*



N



Divisori removibili
Adjustable dividers



Cestello estraibile
Removable caddy



Respinge acqua, olio e macchie
Rivestimento in Teflon®
Repels water, oil and stains
Teflon® fabric protector



Scocca rinforzata
in gomma
Reinforced rubberised
kick plate

Quick Cart

art.	dim. cm.	h.	kg.	int. dim. cm.	cap. kg.	cap. m ³	model
44178-01	41,9x36,3	43,2	6,53	40,6x31,7x36,8	13,6	0,048	SMALL
44178-02	41,9x36,3	53,3	7,17	40,6x31,7x47	18,1	0,060	MEDIUM
44178-03	41,9x36,3	63,5	7,80	40,6x31,7x57,1	27,2	0,074	LARGE

Design elegante. Esperienza affidata. Aspetto discreto: design compatto, poco appariscente agli sguardi nelle aree pubbliche fino a scomparire nelle camere. Design compatto ed ergonomico: leggeri e più compatti rispetto ai carrelli tradizionali, facili da manovrare in spazi ristretti. Scomparti versatili consentono molteplici configurazioni e usi. - *Smart design. Trusted Experience, discreet, appearance : compact design remains inconspicuous by blending into public areas and disappearing into guest rooms. Compact and ergonomic design: lightweight and more compact than traditional carts for easier manoeuvrability in tight spaces. Versatile compartments allow for multiple configurations and uses.*



N

Contenitore tondo, PE
Container, round, PE
Behälter, Rund, PE
Conteneur, rond, PE
Contenedor redondo, PE

art.	ø cm.	h.	lt.
44178-30	61	80	166,5



N

Busta porta utensili, 12 posti
Brute caddy bag, 12 compartments
Rolltasche, 12 Plätze
Pochette, 12 compartements
Estuche para utensilios, 12 comp.

art.	dim. cm.	h.
44178-31	38,7x28,4	4,4

BRUTE® Caddy Bag - Si attacca sul bordo del container BRUTE® 166,5 Lt. Resistente nylon rinforzato vinile, facile da pulire. - *Snaps securely onto the rim of BRUTE® 166.5L container. Durable nylon reinforced vinyl is strong and easy to keep clean.*



Supporto mobile tondo, PE
Dolly, round, PE
Wagen, Rund, PE
Chariot, rond, PE
Soporte móvil redondo, PE

art.	ø cm.	h.	carico/load
49373-90	46,4	16,8	113,4 kg



Sistema di pulizia, kit Pulse
Cleaning system, Pulse
Reinigungssystem Pulse
Système de nettoyage Pulse
Sistema de limpeza Pulse



art.	dim. cm.	h.
44151-00	12,4x9,5	142,2

Telaio in alluminio con velcro da 40 cm, 2 mop in microfibra. Dotato di deposito integrato da 700 ml che permette di pulire fino a 80 mq.
Aluminum frame 40 cm and 2 microfibre mops. On-board reservoir 700 ml that allows to clean up to 80 sqm.

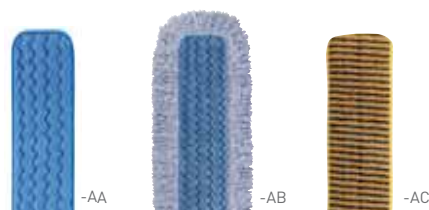

Mop in microfibra, conf. 10 pz
Microfibre mop, 10 pcs pack
Microfiber-Mop, 10 Stück Packung
Frange en microfibra, 10 pcs
Fregadora de microfibra, 10 piezas

art.	dim. cm.	h.	
44151-AA	40x14	1,6	Wet mop
N 44151-AB	40x14	1,6	High absorbency WM
N 44151-AC	40x14	1,6	Scrubber mop

Mop in microfibra, uso umido ad elevata assorbenza, per 80 mq. Ciclo di vita: 500 lavaggi (200 con candeggina) ad elevate temperature. - *Microfibre mop, wet use, high absorbency, for 80 sqm. Launderable up to 500 times (200 with bleach) at high water temperature.*



Aspirapolvere meccanico
Mechanical sweeper
Staubsauger, mechanisch
Balai mécanique
Aspiradora mecánica

art.	dim. cm.	h.	lt.
44150-19	28,6x24,8	101,6	0,6

Battuta/Sweeping path: 19 cm. In ABS e acciaio galvanizzato. Permette di eliminare meccanicamente polvere, capelli e piccoli residui senza uso di corrente o pile. Ideale sia per tappeti/moquette a pelo corto che per pavimenti. - *ABS and galvanized steel construction. Allows to mechanically remove dust, hair and small residuals. Ideal for hard floors and low pile carpets.*



Scopa + alza immondizia, PP
Broom + dust pan, PP
Besen + Müllschaufel, PP
Balai + pelle, PP
Escoba + recogedor, PP

art.	dim. cm.	h.
44149-03	28,6x12,7	32,4

Porta immondizia con coperchio per raccogliere e asportare detriti con discrezione. Staffa di supporto per scopa per trasportare e riporre comodamente e simultaneamente. - *Self opening and closing lid conceals unsightly dirt and debris. Hanger bracket allows for easy pan and broom transport and storage.*



Paletta con serbatoio, PP
Wet/dry spill pan, PP
Schaufel mit Tank, PP
Pelle avec réservoir, PP
Recogedor, PP

art.	dim. cm.	h.	lt.
44148-00	43x31,5	103	2

Permette di raccogliere qualunque tipo di rifiuto solido o liquido.
Allows to collect any type of solid or liquid waste.



Scopa spingiacqua
Cleaning wand
Abzieher
Balai raclette
Escoba

art.	dim. cm.
44148-01	116,8x40

Testa della scopa realizzata in morbida gommaspugna a doppio strato sostenuta da telaio in metallo galvanizzato. - *Blade made of soft double mass squeegee foam supported by a galvanized metal frame.*



Manico per mop
Wet mop handles
Nassmopp-Stiele
Supports pour franges
Mangos para fregonas

art.	l. cm.	colore/color
44141-01	152,4	●
44141-03	152,4	●

Polipropilene/fibra di vetro. - Polypropylene/Glass fiber.

Mop a strisce in cotone
Cotton-end string mop
Spaghetti-Mop mit Baumwollendend
Frangè à ficelles en coton
Fregona de tiras de algodón

art.	gr.
44142-40	400

Alta capacità di assorbimento. La lavorazione delle frange riduce la formazione di grovigli. Il mix equilibrato del cotone a 4 strati resiste a ripetuti lavaggi senza ritirarsi. - High absorbency. Looped-ends and tail banding reduces tangling. The 4-ply, balanced blend of cotton withstands repeated laundering without shrinkage.



Panno in microfibra, conf. 12 pz
Microfibre cloth, 12 pcs pack
Mikrofasertuch, 12 Stück Packung
Carré en microfibre, 12 pcs
Paño de microfibra, 12 piezas

art.	dim. cm.	colore/color
44147-00	40,6x40,6	●
44147-01	40,6x40,6	●
44147-02	40,6x40,6	●
44147-03	40,6x40,6	●

Panno in microfibra, dura 100 lavaggi con candeggina e 250 senza.
Microfibre cloth, launderable up to 100 times with bleach and 250 without bleach.



Cavalletto di segnalazione a 2 lati, PP
2-sided floor sign, PP
2-seitig, Warnschild
Panneau d'avertissement 2 côtés, PP
Señal de suelo 2 lados,

art.	dim. cm.	col.
44077-CC	67,3x27,9x30,5	●
N 44077-CE	67,3x27,9x30,5	●



Programmazione
Programming options



60 / 90 / 120 / 180: giorni/days
8 / 12 / 16 / 24: ore/hours
5 / 6 / 7: giorni per settimana/days per week



Diffusore MB duetto, cromo/nero
Microburst Duet, chrome/black
Luftefrischer Duet, chrom/schwarz
Rafraîchisseur Duet, chrome/noir
Difusor de fragancia, cromo/negro

art.	dim. cm.
44178-60	13,4x9x22,4

Programmazione flessibile. Rotazione spray: ora/ora, mattino/pomeriggio, giorno/giorno, ecc. Alterna automaticamente due fragranze complementari per una sempre rinnovata freschezza. Ogni ricarica dura fino a 180 giorni, le batterie (2x C Cell Alkaline) durano più di 2 anni; minima manutenzione. Spray: 25 µl. - Flexible programming options. Spray rotation: hour to hour, AM to PM, day to day, can to can. Automatically alternates between two complementary fragrances for renewed freshness. Each refill lasts up to 180 days and batteries last over 2 years; very low maintenance needed. Spray: 25 µl. The dispenser requires 2 x C Cell Alkaline batteries.



Ricarica duetto
Duet refills
Duet-Nachfüllpatrone
Recharge Duet
Recambio Duet

art.	dim. cm.	ml.	
44178-61	6,3x9x13,2	2x121	Sparkling fruits/Cotton Berry
44178-62	6,3x9x13,2	2x121	Floral cascade/Vibrant sense
44178-63	6,3x9x13,2	2x121	Clean sense/Cool breeze

Ogni ricarica ha una combinazione unica di aromi. Oli profumati di alta qualità erogati attraverso la tecnologia Microburst® per prestazioni di maggior durata. - Each refill features a unique combination of exclusive aromas. High-quality fragrance oils dispensed through Microburst® technology for longer lasting performance.



Distributore di sapone in schiuma, cromo/nero
AutoFoam™ Dispenser, chrome/black
Schaumseifenspender, chrom/schwarz
Distributeur de savon mousse, chrome/noir
Dispensador de jabón en espuma, cromo/negro

art. dim. cm.
44178-66 14,2x14,2x28,4

Completamente elettronico. Ricarica igienicamente sigillata mantiene il sapone fresco ed evita la contaminazione del prodotto. Con sensore ad avanzata tecnologia e pompa nuova fornita con ogni ricarica per evitare ostruzioni e perdite. Dosi: 0,4 ml. Batterie: 4x D Cell alkaline. - 120.000 erogazioni. - *Completely touch free, helps to control the growth of microorganisms on the skin. Hygienically sealed refill keeps soap fresh and avoids product contamination. With advanced sensor dispenser technology and a new pump supplied with every refill to avoid mess, clogs and leaks. Dose: 0.4ml. One shot Automatic dispensers require 4 x D Cell Alkaline batteries - 120'000 uses.*



Ricarica sapone in schiuma
Foam refill
Schaumseife-Nachfüllpatrone
Recharge de savon mousse
Recambio de jabón en espuma

art. dim. cm. ml.
44178-67 25,5x16x7 1.100 Free'n Clean
44178-68 25,5x16x7 1.100 Lotion Soap

Free'n Clean: Adatto per l'uso nella gestione e trasformazione di prodotti alimentari. Formulazione per pelli sensibili e ideale per lavaggi frequenti. *Suitable for use in food handling and processing. Sensitive skin formulation ideal for frequent hand washing.*

Lotion Soap with Moisturisers: Lozione detergente con agenti idratanti, ideale per applicazioni in toilette. Schiuma concentrata arricchita con balsamo per lenire e ammorbidire la pelle. - *Ideal for washroom applications. High quality, concentrated dense foam formula enriched with conditioners to soothe and soften the skin.*



Scaletta, PP
Ladder, PP
Leiter, PP
Marche-pied pliable, PP
Escalera plegable, PP

art. dim. cm. h.
49378-48 48,6x17,2 63

Scaletta pieghevole, resiste da 0 a 50°C. Capacità di carico 150 kg. Colore nero. *Folding ladder, resists from 0 to 50 °C. Load capacity 150 kg. Black color.*



Cesto a rete, acciaio verniciato nero
Mesh bin, black painted steel
Netz-Eimer
Corbeille à mailles
Colector a red

art. ø cm. h. lt.
44098-29 29 35,6 19



Pattumiera a pedale, PE
Step-on bin, PE
Pedaleimer, PE
Poubelle à pédale, PE
Colector a pedal, PE

art. dim. cm. h. lt.
49895-87 50x41 82,5 87



Pattumiera a pedale, PE ECO STEP-ON
Step on bin, PE
Pedaleimer, PE
Poubelle à pédale, PE
Colector a pedal, PE

art. dim. cm. h. lt.
49896-00 49x45,6 89 106
49896-04 49x45,6 89 106
49896-05 49x45,6 89 106

Impugnatura ergonomica, grande manovrabilità all'interno e all'esterno. Apertura a pedale, coperchio incernierato. Resistente ai raggi UV - non scolorisce alla luce del sole. *Ergonomic handle and large wheels for manoeuvrability indoors and outdoors. Pedal operated hinged lid. UV light stable compound - will not fade in sunlight. Frost resistant.*



Pattumiera a pedale, PE SLIM JIM END STEP
Step on bin, PE
Pedaleimer, PE
Poubelle à pédale, PE
Colector a pedal, PE

art. dim. cm. h. lt.
49933-30 49,7x31 56,6 30
49933-50 52,7x34,3 72,0 50
49933-68 56,1x37,3 78,0 68
49933-90 63,7x40,3 81,3 90

La forma compatta riduce l'ingombro. Chiusura coperchio silenziosa. Apertura a farfalla tramite robusto pedale. Contenitore rigido interno. Superficie facile da pulire. Lt 90 con ruote integrate. - *Space saving, small footprint. Silent lid closure minimises noise level. Commercial grade pedal ensures long product lifecycle. Rigid liner included. Easy to clean surface. 90L has built-in wheels.*



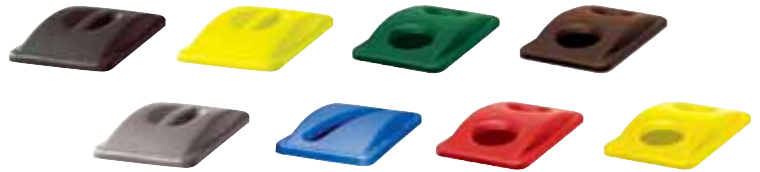

Contenitore rifiuti, PE SLIM JIM
Waste container, PE
Abfallbehälter, PE
Collecteur, PE
Colector, PE

Coperchio, PP
Lid, PP
Deckel, PP
Couvercle, PP
Tapa, PP

art.	dim. cm.	h.	lt.
49931-60	59x28	63	60
N 49931-87	56x28	76	87

art.	dim. cm.	h.	art.	dim. cm.	h.
49931A02	● 51,8x28,7	7	49931B05	● 51,8x28,7	7
49931A01	● 51,8x28,7	7	49931B02	● 51,8x28,7	7
49931A00	● 51,8x28,7	7	49931B03	● 51,8x28,7	7
49931C04	● 51,8x28,7	7	49931B01	● 51,8x28,7	7



Coperchio, stirene ad alto impatto
Lid, high impact styrene
Deckel
Couvercle
Tapa



art.	dim. cm.	h.
49931-01	52,3x29,4	12,7



Coperchio, PP
Lid, PP
Deckel, PP
Couvercle, PP
Tapa, PP



art.	dim. cm.	h.
49931-00	55,6x34,1	3,1



Carrello, PE
Dolly, PE
Transportwagen, PE
Chariot, PE
Carretilla, PE

art.	dim. cm.	h.
49931-64	59,5x38	27,5



Carrello, inox
Dolly, stainless steel
Transportwagen, Edelstahl Rostfrei
Chariot, inox
Carretilla, inox

art.	dim. cm.	h.
49931-65	51,6x23,6	24,1



E' possibile agganciare lateralmente i carrelli. Ruote piroettanti, antitraccia.
Linking trolley moves multiple units in one trip. Swivelling, non marking wheels.



Benna ribaltabile, PE
Tilt truck, PE
Falten Eimerwagen, PE
Benne, PE
Carrito plegable, PE

art.	dim. cm.	h.	lt./kg
49934-04	145x68	86	400/205
49934-06	164x77	97	600/272
49934-08	180x85	107	800/570



Coperchio a doppia apertura, PE
Domed linged lid, PE
Doppel-Deckel, PE
Couverture double, PE
Tapa doble, PE

art.	dim. cm.	h.
49934-14	132x71	23
49934-16	155x81	23
49934-18	169x88	23



Posacenere
Ashtray
Aschenbecher
Cendrier
Cenicero

art.	ø cm.	h.	cap.
49890-02	44	100	1.500



Posacenere
Ashtray
Aschenbecher
Cendrier
Cenicero

art.	ø cm.	h.	cap.
49890-05	42,7	108,7	1.800

N



Fasciatoio da parete, PP
Changing table, PP
Windeln-Tisch, PP
Table à langer, PP
Mesa cambia-pañales, PP

art.	dim. cm.	h.
49336-00	91x71	49,5



Fasciatoio da parete, PP
Changing table, PP
Windeln-Tisch, PP
Table à langer, PP
Mesa cambia-pañales, PP

art.	dim. cm.	h.
49336-02	59,5x87,8	48,3

Applicabile a parete. Portata max in uso 23 kg. - Wall mounting. Rated for continuous use up to 23 kg.

PROGETTO BABY SAFE BABY SAFE PROJECT

La protezione antibatterica Microban incorporata all'interno del seggiolone durante il processo di produzione, aiuta a prevenire l'accumulo di macchie e odori che possono causare la proliferazione dei microbi. Sarà permanente durante tutta la vita utile del prodotto. - *Microban antimicrobial protection - built into the chair during the manufacturing process - helps prevent the growth of stain and odour causing bacteria - will not wash or wear off during the life of the chair.*



Seggiolone, PP
Sturdy chair, PP
Kinderstuhl, PP
Chaise d'enfant, PP
Silla niños, PP

Assicella, PP
Tray, PP
Tablett, PP
Plateau, PP
Bandeja, PP

art.	dim. cm.	h.
49337-00	60x60	75,5

art.	dim. cm.	h.
49337-01	29x47	8,3

Impilabile. Prodotto adatto a bambini fino a 3 anni di età o 18 kg di peso. Robusto polipropilene, con protezione antibatterica in Microban. Progettato per garantire stabilità e sicurezza, con sponda di protezione integrata nello stampo. Facile da pulire e molto resistente. - *Stackable. Suitable for children up to 3 years old or 18 kg weight. Sturdy polypropylene with Microban antimicrobial protection. Designed to ensure stability and safety, with one piece t-bar and safety harness. Easy to clean and very durable.*



Sedile di sicurezza per bambini BABYSEAT
Child safety seat
Kindersitz
Siège enfant
Asiento de seguridad para niños

Cestino per pannolini, PP
Nappy bin, PP
Windelabfallbehälter, PP
Poubelle hygiénique, PP
Cubo para pañales, PP

Cestino rifiuti sanitari, PP
Sanitary waste bin, PP
Sanitärabfallbehälter, PP
Poubelle pour sanitaires, PP
Cubo para higiene femenina, PP

art.	dim. cm.
49336-05	52,7x33,4x10,2

art.	dim. cm.	h.	lt.
49339-65	77x41	47	65

art.	dim. cm.	h.	lt.
49340-20	51x16	57,5	20

Speciale seggiolino che permette di trattenere in sicurezza un infante. Ideale in bagni, centri commerciali, camerini di prova abbigliamento, ecc. Profilo compatto ultra sottile, profondità aperto mm 297, apertura a 87°. Testato per sostenere fino a 90 kg. - *Special seat that allows you to safely hold an infant. Ideal for bathrooms, shopping centers, fitting rooms, etc. Compact profile ultra thin, open depth 297 mm, opening at 87°. Tested to support up to 90 kg.*



Carrello di servizio
Service trolley
Servicewagen
Chariot de service
Carro de habitaciones

art.	dim. cm.	h.	lt.	kg.
44174-24	177x58	107	120+120	26,4

Ruote ø125 mm, 2 portasacco pieghevoli + 2 sacco lt. 120. Prodotto in polipropilene copolimero. - *Wheels ø125 mm, 2 bag holders + 2 bags lt. 120. Made in polypropylene copolymer.*



Carrello di servizio
Service trolley
Servicewagen
Chariot de service
Carro de habitaciones

art.	dim. cm.	h.	lt.	kg.
44177-12	104x56	130	150	26

Base in polipropilene copolimero, montanti in tubolari in acciaio ø 22 mm, verniciato Rilsan. Ruote ø 125 mm. 3 ripiani legno 50x46 cm. Portasacco+sacco in tela poliestere 100% cm. 55x55x94, capacità lt.150. *Polypropylene copolymer base, frame in tubular steel ø 22 mm, Rilsan coated. Wheels ø 125 mm. 3 wooden shelves 50x46 cm. Bag holder + canvas bag 100% polyester cm. 55x55x94, lt. 150.*



Carrello porta biancheria
Service trolley
Servicewagen
Chariot de service
Carro de habitaciones

art.	dim. cm.	h.	lt.	kg.
44176-30	105x55	105	300	12,5

Base in polipropilene copolimero. Montanti tubolari in acciaio ø 22 mm, verniciato Rilsan. Ruote ø 125 mm. Sacco in nylon 210 plastificato. *Polypropylene copolymer base. Tubular frame ø 22 mm, Rilsan coated steel. Wheels ø 125 mm. Bag, nylon 210.*



Carrello porta biancheria
Service trolley
Servicewagen
Chariot de service
Carro de habitaciones

art.	dim. cm.	h.	lt.	kg.
44175-15	62x60	103	150	6,39
44175-18	62x70	103	180	8,50

Capiente sacco in tela plasticata lavabile a 30°. Telaio pieghevole. Ruote piroettanti ø80 mm. - *Capacious canvas bag laminated washable at 30 °. Folding frame. Swivel casters ø80 mm.*



Carrello multiuso, PP
Multi-purpose trolley, PP
Allzweckwagen, PP
Chariot multi-usage, PP
Carro de limpieza, PP

art.	dim. cm.	h.	lt.	kg.
44173-00	97x68	111	120	16,8

Ruote ø100 mm, portasacco + sacco lt. 120 e coperchio, vaschetta con ganci, 2 secchi lt. 4, 2 secchi lt. 15 con strizzatore. *Wheels ø100 mm, bag holder with cover + bag lt. 120, pan with hooks, 2 buckets lt. 4 and 2 buckets lt. 15 with wringer.*



Carrello lavapavimento, PP
Floor cleaning trolley, PP
Bodenreinigungswagen, PP
Chariot pour le lavage du sol, PP
Carro de limpieza, PP

art.	dim. cm.	h.	lt.	kg.
44171-24	62x42	90	25	6,41

Ruote ø80 mm con paracolpi, strizzatore e 1 secchio lt. 25. Vano portaoggetti. Impugnatura in PSV completa di rinforzi. *Wheels ø80 mm with bumpers, wringer and 25 lt. bucket. With storage compartment. PSV reinforced handle.*



Carrello lavapavimento, PP
Floor cleaning trolley, PP
Bodenreinigungswagen, PP
Chariot pour le lavage du sol, PP
Carro de limpieza, PP

art.	dim. cm.	h.	lt.	kg.
44171-50	69x42	90	2x25	7,82

Ruote ø 80 mm con paracolpi, strizzatore e 2 secchi da lt. 25. Impugnatura verniciata, reversibile. - *Wheels ø 80 mm with bumpers, wringer and 2 buckets lt. 25 each. Painted handle, reversible.*



Carrello lavapavimento, PP
Floor cleaning trolley, PP
Bodenreinigungswagen, PP
Chariot pour le lavage du sol, PP
Carro de limpieza, PP

art.	dim. cm.	h.	lt.	kg.
44172-30	47x40	93	30	6,29

Monovasca con strizzatore, ruote ø80 mm. con paracolpi. - Single tank with wringer, wheels ø80 mm. with bumpers.



Secchio graduato, PP
Graduated bucket, PP
Eimer mit Skala, PP
Seau gradué, PP
Cubo con medidas, PP

art.	dim. cm.	h.	lt.	kg.
● 44169B06	24,2x18,8	21,5	6	0,48
● 44169R06	24,2x18,8	21,5	6	0,48



Secchio graduato, PP
Graduated bucket, PP
Eimer mit Skala, PP
Seau gradué, PP
Cubo con medidas, PP

art.	dim. cm.	h.	lt.	kg.
● 44169B14	34x33,5	28,3	15	0,78
● 44169R25	37x36,5	31,7	25	0,99



Secchio con strizzatore, PP
Bucket with wringer, PP
Eimer mit Presse, PP
Seau avec essoreur, PP
Cubo con prensa, PP

art.	dim. cm.	h.	lt.	kg.
44168-12	35x27	29,5	12	0,54

Scala graduata da 0 a 12 lt.
Graduated scale from 0 to 12 lt.



Manico per mop, attacco filettato
Cotton mop rod, screw fitting
Mop-Stange mit Schraubanschluss
Manche pour mop avec attache à vis
Mango para fregadora

art.	ø cm.	l.
44167-13	2,2	130

In ferro verniciato rosso. Leggero ed inossidabile. - Red lacquered iron. Lightweight and rustproof.



Mop in cotone, attacco filettato
Cotton mop, screw fitting
Baumwollmop mit Schraubanschluss
Mop en coton avec attache à vis
Fregadora de algodón

art.	gr.
44166-28	280



Manico telescopico, alluminio
Telescopic rod, aluminum
Teleskopstange, Aluminum
Manche telescopique, aluminum
Mango telescópico, aluminio

art.	ø cm.	l.
44161-00	2,3	97→184

Alluminio anodizzato due pezzi.
Two-piece anodized aluminum rod.



Pinza per mop, PP
Mop holder, PP
Wischnophalter, PP
Pince faubert, PP
Pinza, PP

art.
44164-00

Ghiera universale consente l'utilizzo di qualsiasi manico con ø 20→ø 24 mm.
Universal ring allows the use of any handle with from ø 20 to ø 24 mm.



Mop a strisce in cotone
Cotton-end string mop
Spaghetti-Mop mit Baumwollend
Frange à ficelles en coton
Fregona de tiras de algodón

art.	gr.
44165-35	350
44165-40	400
44165-50	500



Scopa a forbice completa
Dust beater "V" sweeper complete
Doppel-Wischmop
Balai double mop
Escoba doble

art. h. cm.
44160-03 135

Apertura 140° circa. Frange in cotone cm.100. - Opening angle 140° about. Cotton mops length 100 cm.



Lavamani autonomo, inox
Autonomous hand wash basin, stainless steel
Mobiles Handwaschbecken
Lave-mains autonome, inox
Lavamanos portátil autónomo

art. dim. cm. h.
49873-26 41,5x34,5 120



Costruzione in acciaio inox, 2 ruote fisse e impugnatura per il trasporto. Vasca profondità mm 115. Comando a pedale. Il vano posteriore accoglie 2 taniche da 13 lt (1 per l'acqua pulita, 1 per l'acqua sporca). Completo di distributore sapone e getta-carte agganciabile. Funzionamento con pompa elettrica con 2 batterie da 6V fornite. - Stainless steel construction, 2 fixed casters and carrying handle. Bath depth 115 mm. Pedal control. The rear compartment accommodates 2 tanks of 13 liters (1 for clean water, 1 for dirty water). Complete with soap dispenser and bin. Electric pump operated with 2 6V batteries included.



Cavalletto di segnalazione a 2 lati, PP
2-sided floor sign, PP
2-seitig, Warnschild, PP
Panneau d'avertissement 2 côtés, PP
Señal de suelo 2 lados, PP

art. h. cm.
44077-00 57



Paletta manico lungo
Dustpan
Müllschaufel
Pelle à poussière
Recogedor

art.
44170-00



Scopa, manico alluminio
Broom, aluminum rod
Besen mit Alu-Stange
Balai, manche alu
Escoba, mango alumimio

art. ø cm. l.
44170-01 21 80



Carrello portasacco
Refuse bag holder trolley
Sackhalterwagen
Chariot porte-sac
Colector móvil

art. dim. cm. h. lt. kg.
44089-12 58x56 102 120 6,1

Verniciato rosso con polvere epossidica, elastico fermasacco e ruote piroettanti ø80 mm. - Red painted with epoxy powder, with elastic bag holder and castors ø80 mm.



Pattumiera a pedale, PP
Mobile pedal bin
Pedaleimer
Poubelle à pédale
Colector con tapa, abertura pedal

art. dim. cm. h. lt.
44095-18 40x65 81 80



Pattumiera a pedale, PE-HD
Step-on bin
Pedaleimer
Poubelle à pédale
Colector a pedal

art. dim. cm. h. lt.
44095-12 48x55 93 120

Certificata UNI EN 840. Resistente agli agenti chimici, lavabile e sterilizzabile. Certified UNI EN 840. Withstanding chemical, can be washed and sterilized.



Carrello vuoti, PP
Bottle trolley, PP
Leerflaschen-Wagen, PP
Chariot à verre, PP
Carro colector de botellas, PP

art. dim. cm. h. lt.
44096-12 66x46 68 122



Pattumiera a pedale, PP
Step-on bin
Pedaleimer
Poubelle à pédale
Colector a pedal

art.	lt.
44097-08	8



Pattumiera a pedale, ignifuga
Pedal bin, fire-proof
Pedaleimer, feuersicher
Poubelle à pédale, ignifugée
Colector a pedal, ignífugo

art.	dim. cm.	lt.	col.
49899-01	46x32x80	70	grigio/grey
49899-02	46x32x80	70	giallo/yellow
49899-03	46x32x80	70	verde/green
49899-04	46x32x80	70	rosso/red
49899-05	46x32x80	70	blu/blue

In polipropilene, ignifugo a norma di legge. Parti meccaniche in acciaio inox. Angoli arrotondati e superfici lisce, per una facile e veloce pulizia. Coperchio staccabile. Si possono impiegare sacchi standard con capacità 70 lt. Ideale per l'utilizzo in gruppo, nei casi di raccolta differenziata. Apertura del coperchio azionata da pedale. La speciale dinamica di apertura e chiusura del coperchio è in grado di soffocare le fiamme e non consente l'ingresso di aria nuova all'interno del raccoglitore. - Polypropylene construction, fire-proof. All mechanical parts are made in stainless steel. Its rounded off corners and smooth surfaces make it easy and quick to clean. The lid can be removed. You can use standard disposable 70 lt bags. Ideal to be used in group, when a separate refuse collect is requested. Lid opening is operated by pedal. The special opening and closing lid system is able to put out fire and does not allow oxygen to enter into the bin.



Cestino, PP
Waste container
Abfallbehälter
Collecteur
Contenedor

art.	ø. cm.	h.
44097-00	30	32



Pallet, PE-HD
Pallet
Pallet
Palette
Racks para suelos

art.	dim. cm.	kg.	*kg.
49373-05	80x120	4,6	1000

* Carico statico. Per uso alimentare.
* Static load. Appropriate for food.



Pedana
Dunnage rack
Lageruntersätze
Palettes
Bancada

art.	dim. cm.	h.	Carico/Load
49371-09	91,4x55,9	30,5	68 kg
49371-12	121,9x55,9	30,5	136 kg

Materiale polimerico resistente alla ruggine e alla corrosione. - Rust and corrosion-proof polymer material.



Posacenere a colonna, inox
Floor standing ashtray, stainless steel
Standascher/Abfalleimer
Cendrier sur pied, inox
Contenedor con cenicero, inox

art.	ø cm.	dim.	h.	lt.
49897-09	9	24x24	86	3



Posacenere/pattumiera, inox
Standing ashtray/bin, stainless steel
Standascher/Abfalleimer
Cendrier/poubelle, inox
Cenicero/papelera, inox

art.	ø cm.	h.
49898-30	30	60

Incl. sacchetto sabbia kg 1,5.
Included bag of sand 1,5 kg.

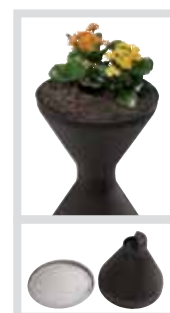

Posacenere/fioriera, PP
Standing ashtray, PP
Standascher, PP
Cendrier sur pied, PP
Cenicero, PP

art.	ø cm.	h.
49892-40	40	60

Incl. sacchetto sabbia kg 1,5.
Included bag of sand 1,5 kg.





TAVOLA
TABLE TOP SERVICE
TISCHSERVICE
SERVICE DE TABLE
SERVICIO DE MESA

VASELLAME INOX 18-10
HOLLOWWARE 18-10 STAINLESS STEEL

Arthur Krupp®





Caffettiera
Coffee pot
Kaffeekanne
Cafetière
Cafetera

art.	lt.
66201-03	0,30
66201-06	0,60
66201-09	0,90
66201-16	1,60



Teiera
Tea pot
Teekanne
Théière
Tetera

art.	lt.
66208-03	0,30
66208-06	0,60
66208-09	0,90



Lattiera / Cremiera
Milk pot / Creamer
Milchgießer / Gießer
Pot à lait / Crémier
Jarra leche / Jarrita

art.	lt.
66204-01	0,15
66206-03	0,30
66206-06	0,60
66206-09	0,90



Brocca acqua
Water jug
Eiswasserkrug
Carafe à eau
Jarra agua

art.	lt.
66216-16	1,6

Con ferma ghiaccio. - With ice guard.



Caraffa termica
Insulated beverage server
Thermokanne
Pot isotherme
Jarra térmica

art.	lt.
66214-05	0,50
66214-08	0,80



Caraffa termica
Insulated beverage server
Thermokanne
Pot isotherme
Jarra térmica

art.	lt.
66215-06	0,60
66215-08	0,80
66215-12	1,20
66215-16	1,60



Ciotolina
Small bowl
Schale
Petite coupelle
Bol

art.	dim. cm.	h.
66290-25	11,5x9,5	3,5



Zuccheriera c/coperchio
Sugar bowl with cover
Zuckerdose mit Deckel
Sucrier avec couvercle
Azucarero con tapa

art.	dim. cm.	h.
66210-25	9,5x7	5



Zuccheriera
Sugar bowl
Zuckerdose
Sucrier
Azucarero

art.	dim. cm.	h.
66210-05	9,5x7	5



Lattiera/teiera
Milk pot/tea pot
Milchgießer/Teekanne
Pot à lait/théière
Jarra leche/tetera

art.	lt.
66303-01	0,15
66303-03	0,30
66303-06	0,60



Lattiera cappuccino
Cappuccino milk pot
Capuccino-Milchkanne
Pot à cappuccino
Jarra cappuccino

art.	lt.
66307-06	0,60
66307-09	0,90
66307-12	1,20



Porta cucchiaini
Spoon holder
Kaffeelöffelbehälter
Porte cuillères
Porta cucharas

art.	ø cm.	h.
66313-03	6	9



Porta cannucce
Straw holder
Röhrchenbehälter
Porte chalumeaux
Porta canutillos

art.	ø cm.	h.
66313-06	8	12



Portatovaglioli
Napkin holder
Serviettenhalter
Porte serviettes
Servillettero

art.	dim. cm.	h.
66391-00	10x3	8



Portabustine tè
Tea bag caddy
Teebeutel-Halter
Porte sachet de thé
Contenedor sobres té

art.	dim. cm.	h.
66375-00	12,5x7	4



Portabustine zucchero
Sugar bags holder
Zuckertutenschale
Conteneur à sucre
Contenedor sobres azúcar

art.	dim. cm.	h.
66374-00	12,5x6	4



Coppetta
Small bowl
Schale, klein
Petit bol
Copa

art.	ø cm.	h.
66388-10	8	3,5



Cesto pane, ovale
Oval bread basket
Brotschale, oval
Panier à pain, ovale
Cesta pan, oval

art.	dim. cm.	h.
66392-18	18x22	5
66392-22	22x16	5



Portamarmellata
Jam/honey stand
Ständer für Konfiturgläser
Porte confitures
Soporte confituras

art. h. cm.
66367-03 17,5



Portamarmellata
Jam/honey stand
Ständer für Konfiturgläser
Porte confitures
Soporte confituras

art. h. cm.
66367-06 15,5



Alzata dolci, 2 piani
Pastry stand, 2 tiers
Gebäckständer, 2-stöckig
Serveur muet, 2 étages
Soporte dulces, 2 niveles

art. ø cm. h.
66339-02 12-16 20



Sottobicchiere
Glass saucer
Gläser-teller
Sous-verre
Platito bajo vasos

art. ø cm.
66359-10 10



Sottobottiglia
Bottle saucer
Flaschenteller
Sous bouteille
Platito bajo botellas

art. ø cm.
66359-12 12



Piattino pane
Bread dish
Brotteller
Petite plat à pain
Plato para pan

art. ø cm.
66392-16 16



Piatto presentazione
Show plate
Platzteller
Plat de présentation
Plato de presentación

art. ø cm.
66332-32 32



Porta olio/aceto
Oil and winegar stand
Essig u. Öl-Stand
Porte huile et vinaigre
Soporte para aceite y vinagre

art. dim. cm. h.
66362-02 12,5x6 27



Copripiatto
Plate cover
Tellerlocke
Cloche
Cubreplatos

art. ø cm.
66340-19 19,0
66340-20 20,0
66340-24 24,0
66340-25 25,0
66340-26 26,0
66340-76 26,5
66340-27 27,0
66340-77 27,5
66340-28 28,0
66340-78 28,5
66340-29 29,0
66340-79 29,5
66340-30 30,0
66340-31 31,0
66340-32 32,0
66340-83 33,5



Set porta conto, inox 18 Cr
Bill Holder, 18 Cr stainless steel
Rechnungshalter
Porte-addition, inox 18 Cr
Porta facturas, acero 18 Cr

art. dim. cm.
66318-39 20x16



Vassoio conto, inox 18 Cr
Cash tray, 18 Cr stainless steel
Rechnungstablett, Edelstahl 18 Cr
Plateau porte-monnaie, inox 18 Cr
Bandeja cuentas, acero 18 Cr

art. dim. cm.
66318-19 19x14
66318-22 22x15



Vassoio conto con molla, inox 18 Cr
 Cash tray with spring, 18 Cr stainless steel
 Rechnungstablett mit Feder, Edelstahl 18 Cr
 Porte note avec pince, inox 18 Cr
 Bandeja cuentas con resorte, acero 18 Cr

art.	dim. cm.
66318-29	19x14



Piatto pesce
 Fish dish
 Fischplatte
 Plat à poisson
 Bandeja pescado

art.	dim. cm.
66345-55	55x23
66345-65	65x27
66345-74	74x29



Vassoio
 Tray
 Tablett
 Plateau
 Bandeja

art.	dim. cm.
66324-40	40x26
66324-50	50x38
66324-65	65x50
56024-85	85x50
56024-99	100x50



Vassoio
 Tray
 Tablett
 Plateau
 Bandeja

art.	dim. cm.
66320-28	28x20
66320-35	35x30
66320-40	40x26
66320-50	50x38
66320-65	65x50
56020-85	85x50
56020-99	100x50



PORCELLANA - PORCELAIN

Arthur Krupp®
PORCELAIN



Arthur Krupp® Porcelain — Made in Germany — presenta un assortimento di articoli in porcellana, una gamma professionale pensata per tutte le occasioni d'utilizzo del settore Ho.Re.Ca., dalle mise en place formali ed eleganti a quelle all'insegna dei mix and match più creativi fino a raffinati banchetti e buffet. La qualità del materiale utilizzato, unitamente agli spessori rinforzati, rende queste porcellane estremamente resistenti a urti e rotture, conferendo loro caratteristiche di praticità e durevolezza. Ideali per un utilizzo quotidiano e duraturo.

Arthur Krupp® Porcelain - Made in Germany - introduces a comprehensive range of items in porcelain, a wide selection of professional products designed to meet any needs of the Ho.Re.Ca. sector. Whether classic and elegant mise en place, a creative mix and match, or for a refined buffet, AKP is the right solution. The high-quality materials and the reinforced edges make these items extremely resistant against chipping, giving them the distinctive features of versatility and durability for daily use.



Piatto piano
Flat plate
Teller flach
Assiette plate
Plato llano

Piatto fondo
Soup plate
Teller tief
Assiette creuse
Plato hondo

Piatto ovale
Oval meat dish
Platte oval
Plat oval
Plato oval

art.	ø cm.
67308-01	16
67308-02	19
67308-03	22
67308-04	25
67308-05	28
67308-06	31

art.	ø cm.
67308-09	21
67308-10	24
67308-11	30

art.	dim. cm.
67308-29	26x20,5
67308-30	32x25,5
67308-31	38x30,5



Coppa
Bowl
Schüssel
Bol
Bol

Insalatiera
Salad bowl
Schüssel
Saladier
Bol ensalada

Candeliere
Candleholder
Leuchter
Bougeoir
Candelabro

art.	ø cm.	h.
67308-80	8	5,0
67308-81	11	8,5
67308-82	13	8,0

art.	ø cm.	h.
67308-68	21	10,0
67308-69	25	12,0
67308-70	28	14,5

art.	ø cm.	h.
67308-87	8,5	24





Tazza
Cup
Obertasse
Tasse
Taza

art. ø cm. h. lt.
67308-40 6,5 5,5 0,10



Piattino
Saucer
Untertasse
Soucoupe
Platillo

art. cm.
67308-16 12



Tazza
Cup
Obertasse
Tasse
Taza

art. ø cm. h. lt.
67308-41 8 6,5 0,18



Piattino
Saucer
Untertasse
Soucoupe
Platillo

art. cm.
67308-17 15



Tazza
Cup
Obertasse
Tasse
Taza

art. ø cm. h. lt.
67308-45 8,5 7 0,22



Piattino
Saucer
Untertasse
Soucoupe
Platillo

art. cm.
67308-17 15



Zuccheriera senza coperchio
Sugar bowl without lid
Zuckerdose ohne Deckel
Sucrier sans couvercle
Azucarera sin tapa

art. ø cm. h. lt.
67308-62 8 6 0,15



Coperchio
Lid
Deckel
Couvercle
Tapa

art. ø cm. h.
67308-63 6,5 2,5



Caffettiera senza coperchio
Coffee pot without lid
Kaffeekannen-Unterteil
Cafetière sans couvercle
Cafetera sin tapa

art. dim. cm. h. lt.
67308-49 13x8 11 0,30



Coperchio
Lid
Deckel
Couvercle
Tapa

art. ø cm. h.
67308-50 6 3,5



Teiera senza coperchio
Teapot without lid
Teekannen-Unterteil
Théière sans couvercle
Tetera sin tapa

art. dim. cm. h. lt.
67308-53 15x10 9,5 0,40



Coperchio
Lid
Deckel
Couvercle
Tapa

art. ø cm. h.
67308-54 8 3,5



Lattiera
Milk pot
Gießer
Crémier
Cremera

art. dim. cm. h. lt.
67308-58 10,5x6 9 0,15
67308-59 13x8 11 0,30



Cremiera
Creamer
Gießer
Crémier
Cremera

art. dim. cm. h. lt.
67308-57 5x4 5,5 0,03



Luce da tavola
Table light
Tischlicht
Lampe à bougie
Porta-vela

art. ø cm. h.
67308-67 7 6



Piatto piano
Flat plate
Teller flach
Assiette plate
Plato llano

art.	ø cm.
67303-01	16
67303-02	19
67303-03	22
67303-04	25
67303-05	27
67303-06	30



Piatto fondo
Soup plate
Teller tief
Assiette creuse
Plato hondo

art.	ø cm.
67303-09	21
67303-10	26
67303-11	30



Piatto ovale
Oval meat dish
Platte oval
Plat oval
Plato oval

art.	dim. cm.
67303-29	30x20
67303-30	35x25



Coppa
Bowl
Schüssel
Bol
Bol

art.	ø cm.	h.
67303-77	12	4



Coppa
Bowl
Schüssel
Bol
Bol

art.	ø cm.	h.
67303-80	12	5
67303-81	15	6
67303-82	17	7



Tazza brodo
Soup bowl
Suppentasse
Bol à soupe
Bol/taza sopa

art.	ø cm.	h.	lt.
67303-22	10	5	0,25

Piattino combi
Combi saucer
Kombi Untertasse
Soucoupe
Platillo

art.	ø cm.
67303-19	17



Tazza brodo con maniglie
Soup bowl with handles
Suppentasse mit Griffen
Bol à soupe avec anses
Bol/taza sopa con asas

art.	ø cm.	h.	lt.
67303-23	10	5	0,25



Salsiera
Sauce boat
Saucière
Saucière
Salsera

art.	lt.
67303-78	0,30
67303-79	0,20



Piattino salsa
Sauce plate
Dipschale
Assiette à sauce
Platillo salsa

art.	ø cm.	h.
67303-20	9	1,5



Spargipepe
Pepper shaker
Pfefferstreuer
Poirrier
Pimentero

art.	ø cm.	h.
67303-97	4	6



Spargisale
Salt shaker
Salzstreuer
Salière
Salero

art.	ø cm.	h.
67303-96	4	6



Portastecchi
Tooth pick holder
Zahnstocher-Halter
Porte cure-dents
Palillero

art.	ø cm.	h.
67303-98	4	7



Vasetto fiori
Flower vase
Blumenvase
Vase à fl eurs
Florero

art.	ø cm.	h.
67303-86	6,5	10



Porta bustine zucchero/tè
Sugar/tea bags holder
Tee/Zuckerpäckchen-Halter
Porte-sachet de sucre/thé
Contenedor sobres azúcar/té

art.	dim cm.	h.
67303-64	11x6	4



Tazza impilabile
Coffee cup stackable
Obertasse stapelbar
Tasse empilable
Taza apilable

art.	ø cm.	h.	lt.
67303-40	6	6	0,10



Piattino
Saucer
Untertasse
Soucoupe
Platillo

art.	cm.
67303-16	12



Tazza impilabile
Coffee cup stackable
Obertasse stapelbar
Tasse empilable
Taza apilable

art.	ø cm.	h.	lt.
67303-41	7,5	7	0,18



Piattino
Saucer
Untertasse
Soucoupe
Platillo

art.	cm.
67303-17	15



Tazza
Cup
Obertasse
Tasse
Taza

art.	ø cm.	h.	lt.
67303-45	7,5	8	0,22



Piattino
Saucer
Untertasse
Soucoupe
Platillo

art.	cm.
67303-19	17



Zuccheriera senza coperchio
Sugar bowl without lid
Zuckerdose ohne Deckel
Sucrier sans couvercle
Azucarera sin tapa

art.	ø cm.	h.
67303-62	7,5	8



Coperchio
Lid
Deckel
Couvercle
Tapa

art.	ø cm.
67303-63	7,5



Caffettiera senza coperchio
Coffee pot without lid
Kaffeekannen-Unterteil
Cafetière sans couvercle
Cafetera sin tapa

art.	ø cm.	h.	lt.
67303-49	8,5	12	0,30
67303-51	10,0	16	0,60



Coperchio
Lid
Deckel
Couvercle
Tapa

art.	ø cm.
67303-50	7,5
67303-52	9,0



Teiera senza coperchio
Teapot without lid
Teekannen-Unterteil
Théière sans couvercle
Tetera sin tapa

art.	ø cm.	h.	lt.
67303-53	12	9	0,40
67303-55	15	11	0,70



Coperchio
Lid
Deckel
Couvercle
Tapa

art.	ø cm.
67303-54	7,5
67303-56	9,0



Lattiera
Milk pot
Gießler
Crémier
Cremera

art.	ø cm.	h.	lt.
67303-58	7	8	0,15
67303-59	8	11	0,30



Cremera
Creamer
Gießler
Crémier
Cremera

art.	ø cm.	h.	lt.
67303-57	4,5	5	0,03



Mug con manico
Mug with handle
Becher mit Henkel
Gobelet avec anse
Mug con asa

art.	ø cm.	h.	lt.
67303-44	7,5	9	0,25



Ciotolina "Seesaw"
Small dish "Seesaw"
Schale "Seesaw"
Petite assiette "Seesaw"
Platillo "Seesaw"

art.	dim. cm.	h.
67303M01	9x7	3



Piattino "Gondola"
Small dish "Gondola"
Schale "Gondola"
Petite assiette "Gondola"
Platillo "Gondola"

art.	dim. cm.	h.
67303M02	14x7	2



Piattino "Trident"
Small dish "Trident"
Schale "Trident"
Petite assiette "Trident"
Platillo "Trident"

art.	ø cm.	h.
67303M03	10	2



Piattino "Rondel"
Small dish "Rondel"
Schale "Rondel"
Petite assiette "Rondel"
Platillo "Rondel"

art.	ø cm.	h.
67303M04	10,5	2



Ciotolina "Coppetta"
Small dish "Coppetta"
Kleine Schale "Coppetta"
Petite assiette "Coppetta"
Platillo "Coppetta"

art.	dim. cm.
67303M05	11x8
67303M06	16x11



Cucchiaio cinese
Chinese spoon
Porzellanlöffel
Cuillère chinoise
Cucharita

art.	l. cm.
67303M07	13





Piatto piano quadro
Flat square plate
Teller flach quadratisch
Assiette plate carrée
Plato llano cuadrado

art.	dim. cm.
67303Q01	23x23
67303Q02	28x28



Piatto fondo quadro
Deep square plate
Teller tief quadratisch
Assiette creuse carrée
Plato hondo cuadrado

art.	dim. cm.
67303Q10	23x23



Piattino piano quadrato
Flat square plate
Teller flach quadratisch
Petite assiette plate carrée
Platillo llano cuadrado

art.	dim. cm.
67303Q80	9x9
67303Q81	12x12



Piattino fondo quadrato
Deep square plate
Teller tief quadratisch
Petite assiette creuse carrée
Platillo hondo cuadrado

art.	dim. cm.
67303Q82	9x9
67303Q83	12x12



Piatto rettangolare
Rectangular plate
Platte rechteckig
Assiette rectangulaire
Plato rectangular

art.	dim. cm.
67303Q29	18x11
67303Q30	29x19



Ciotola quadra
Squared bowl
Schüssel rechteckig
Bol carré
Bol cuadrado

art.	dim. cm.
67303Q84	23x23





Piatto piano
Flat plate
Teller flach
Assiette plate
Plato llano

art.	ø cm.
67305-01	16
67305-02	21
67305-03	25
67305-04	28
67305-05	33



Piatto fondo
Soup plate
Teller tief
Assiette creuse
Plato hondo

art.	ø cm.
67305-09	17
67305-10	22
67305-11	28



Piatto ovale
Oval meat dish
Platte oval
Plat oval
Plato oval

art.	dim. cm.
67305-29	24x20
67305-30	28x24
67305-31	34x29



Tazza brodo
Soup bowl
Suppentasse
Bol à soupe
Bol/taza sopa

art.	ø cm.	h.	lt.
67305-22	12	6	0,30



Piattino
Coffee saucer
Untertasse
Soucoupe
Platillo

art.	ø cm.
67305-19	18



Tazza brodo con maniglie
Soup bowl with handles
Suppentasse mit Griffen
Bol à soupe avec anses
Bol/taza sopa con asas

art.	ø cm.	h.	lt.
67305-23	12	6	0,30



Piattino
Coffee saucer
Untertasse
Soucoupe
Platillo

art.	ø cm.
67305-19	18



Coppa
Bowl
Schüssel
Bol
Bol

art.	ø cm.	h.
67305-80	12	8
67305-81	15	7
67305-82	20	8
67305-83	27	10



Coppa alta
Deep bowl
Schüssel tief
Bol
Bol

art.	ø cm.	h.
67305-84	20	12



Salsiera
Sauce boat
Sauciere
Saucière
Salsera

art.	ø cm.	h.	lt.
67305-78	12	8	0,50
67305-79	10	6	0,25



Tazza impilabile
Coffee cup stackable
Obertasse stapelbar
Tasse empilable
Taza apilable

art.	ø cm.	h.	lt.
67305-40	6,5	5	0,10



Piattino
Saucer
Untertasse
Soucoupe
Platillo

art.	cm.
67305-15	13



Tazza impilabile
Coffee cup stackable
Obertasse stapelbar
Tasse empilable
Taza apilable

art.	ø cm.	h.	lt.
67305-41	8,5	6	0,18



Piattino
Saucer
Untertasse
Soucoupe
Platillo

art.	cm.
67305-17	15



Tazza impilabile
Coffee cup stackable
Obertasse stapelbar
Tasse empilable
Taza apilable

art.	ø cm.	h.	lt.
67305-45	8,5	7	0,22



Piattino
Saucer
Untertasse
Soucoupe
Platillo

art.	cm.
67305-17	15



Zuccheriera senza coperchio
Sugar bowl without lid
Zuckerdose ohne Deckel
Sucrier sans couvercle
Azucarera sin tapa

art.	ø cm.	h.	lt.
67305-62	10	7	0,28



Coperchio
Lid
Deckel
Couvercle
Tapa

art.	ø cm.	h.
67305-63	10,5	1



Caffettiera senza coperchio
Coffee pot without lid
Kaffeekannen-Unterteil
Cafetière sans couvercle
Cafetera sin tapa

art.	ø cm.	h.	lt.
67305-49	10	7	0,30
67305-51	19	10	0,60



Coperchio
Lid
Deckel
Couvercle
Tapa

art.	ø cm.	h.
67305-50	8	2,5
67305-52	9	3,0



Teiera senza coperchio
Teapot without lid
Teekannen-Unterteil
Théière sans couvercle
Tetera sin tapa

art.	ø cm.	h.	lt.
67305-53	12	8	0,40
67305-55	14	10	0,70



Coperchio
Lid
Deckel
Couvercle
Tapa

art.	ø cm.	h.
67305-54	9,5	2,5
67305-56	9,0	3,0



Cremiera
Creamer
Gießer
Crémier
Cremera

art.	ø cm.	h.	lt.
67305-57	7	11	0,20



Mug con manico
Mug with handle
Becher mit Henkel
Gobelet avec anse
Mug con asa

art.	ø cm.	h.	lt.
67305-44	8,5	10	0,30



POSATERIA - *FLATWARE*

Arthur Krupp®

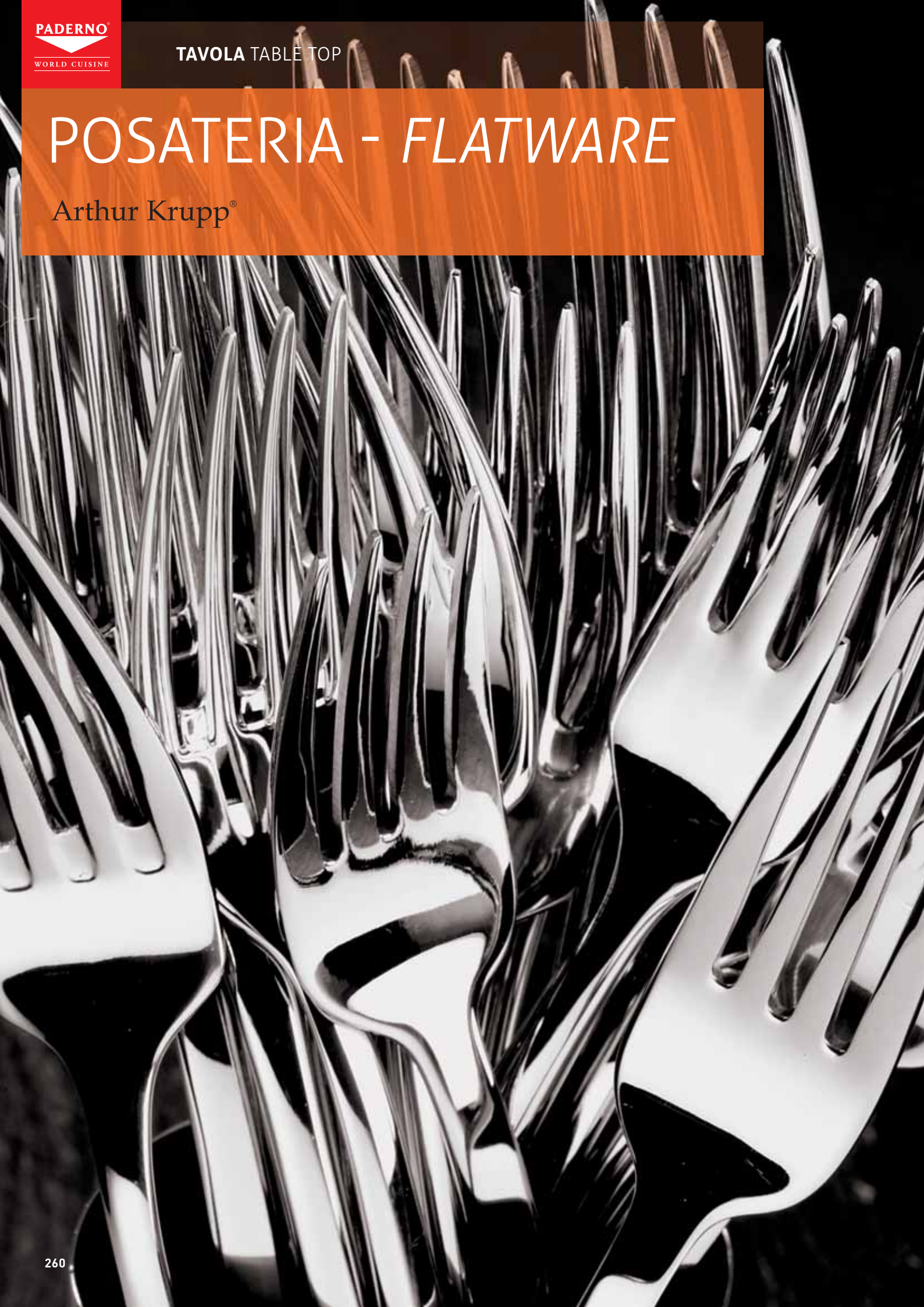

Legenda - Key

Le sagome delle posate sono puramente indicative.
The flatware shapes are only representatives.

Tutti i coltelli hanno la lama seghettata.
All knives with serrated blade.

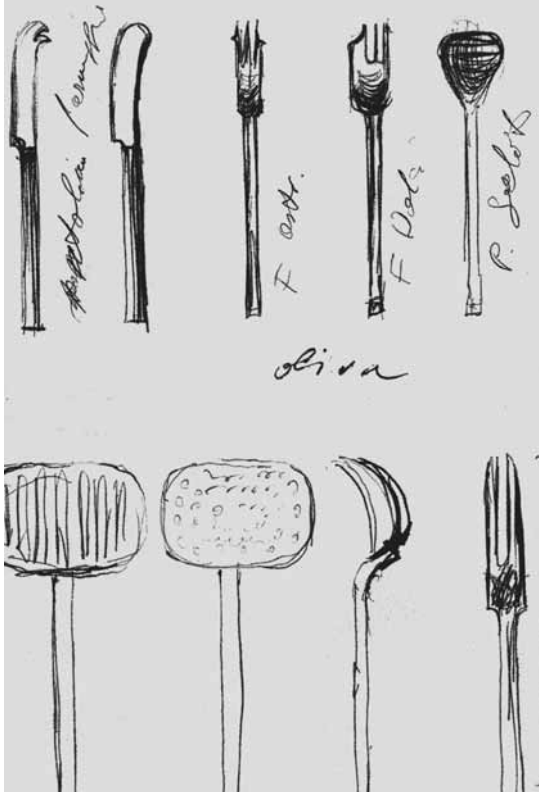

Art.		
-01	Cucchiaio tavola	Table spoon
-08	Forchetta tavola	Table fork
-11	Coltello tavola, monoblocco	Table knife, s.h.
-15	Coltello tavola, manico cavo	Table knife, h.h.
-25	Cucchiaio frutta	Dessert spoon
-26	Forchetta frutta	Dessert fork
-27	Coltello frutta, monoblocco	Dessert knife, s.h.
-31	Coltello frutta, manico cavo	Dessert knife, h.h.
-36	Cucchiaino thè	Tea/coffee spoon
-37	Cucchiaino moka	Moka spoon
-40	Mestolo	Soup ladle
-44	Cucchiaio legumi	Serving spoon
-45	Forchetta legumi	Serving fork
-49	Forchetta pesce	Fish fork
-50	Coltello pesce	Fish knife
-55	Forchetta dolce	Cake cutting fork
-57	Paletta gelato	Ice cream spoon
-58	Pala torta	Cake server
-67	Cucchiaio bibita	Iced tea spoon
-69	Cucchiaio salsa	French sauce spoon
-02	Cucchiaio brodo	Bouillon spoon
-70	Spatola burro	Butter spreader
-73	Coltello burro, monoblocco	Butter knife, s.h.
-72	Coltello burro, m. cavo	Butter knife, h.h.
-18	Coltello burro bimbo, monoblocco	Butter knife, small, s.h.
-16	Coltello burro bimbo, m.cavo	Butter knife, small, h.h.
-19	Coltello bistecca, monoblocco	Steak knife, s.h.
-21	Coltello bistecca, m. cavo	Steak knife, h.h.



Cream

Acciaio inossidabile 18-10
18-10 Stainless steel
62511



Acciaio inossidabile 18-10 argentato
Electrosilverplated 18-10 stainless steel
62711

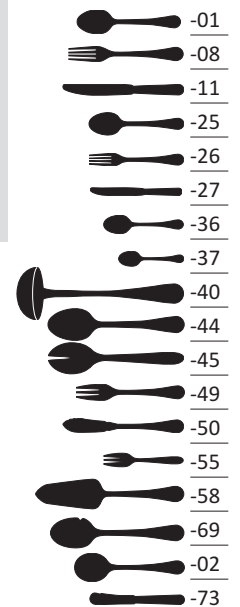

* pack appendibile su richiesta - Hanging packaging on demand



Baguette

Acciaio inossidabile 18-10
18-10 Stainless steel
62612

Acciaio inossidabile 18-10 argentato
Electrosilverplated 18-10 stainless steel
62812

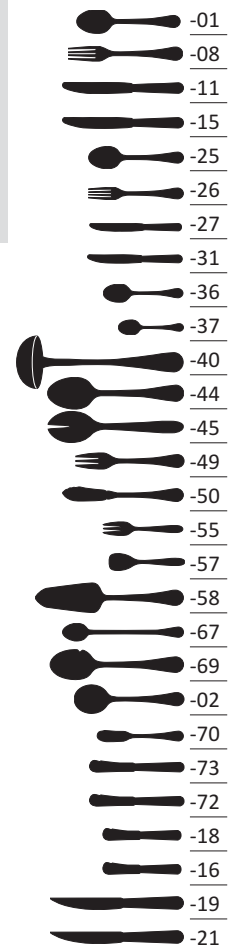

Contour

Acciaio inossidabile 18-10
18-10 Stainless steel
62611

Acciaio inossidabile 18-10 argentato
Electrosilverplated 18-10 stainless steel
62811

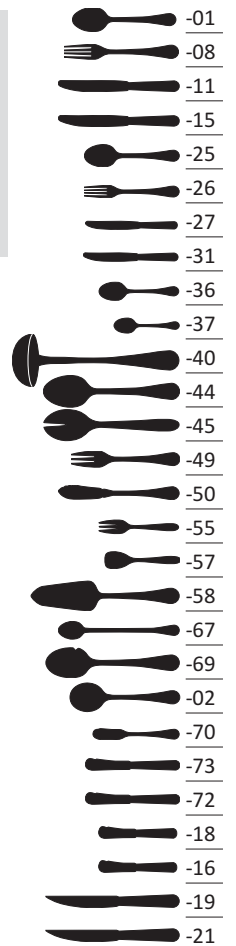

Arcadia

Acciaio inossidabile 18-10
18-10 Stainless steel
62614

Acciaio inossidabile 18-10 argentato
Electrosilverplated 18-10 stainless steel
62814

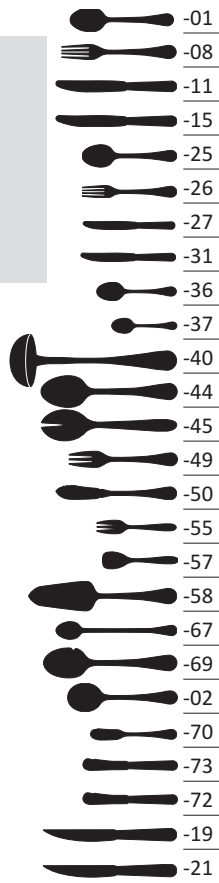

Monika

Acciaio inossidabile 18-10
18-10 Stainless steel
62613



Acciaio inossidabile 18-10 argentato
Electrosilverplated 18-10 stainless steel
62813

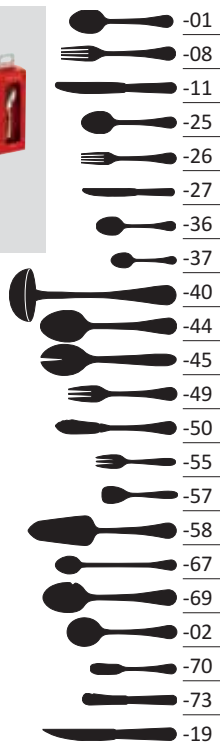

* pack appendibile su richiesta - Hanging packaging on demand





London

Acciaio inossidabile 18-10
18-10 Stainless steel
62615

Acciaio inossidabile 18-10 argentato
Electrosilverplated 18-10 stainless steel
62815

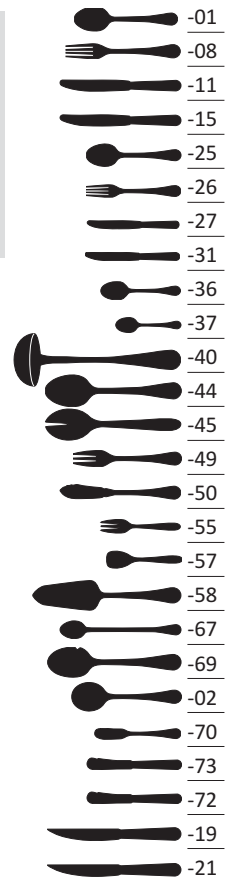

Versailles

Acciaio inossidabile 18-10
18-10 Stainless steel
62618

Acciaio inossidabile 18-10 argentato
Electrosilverplated 18-10 stainless steel
62818

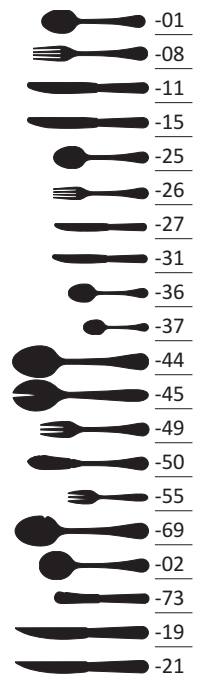

P SERIE LIVING



Una linea completa capace di coniugare assortimento, bellezza, robustezza e funzionalità, realizzata in acciaio inox. Oggetti di qualità per apparecchiare le tavole ed i buffet più raffinati, ma anche per disporre quotidianamente di una cucina super-attrezzata. Il modo più pratico per servire con eleganza e facilità ogni tipo di pietanza dagli spaghetti alla carne, pesce, pane, verdure, formaggi e frutta ma anche piccoli alimenti come dolci, olive e sottaceti. Niente potrà sfuggire inavvertitamente!

A complete stainless steel line, that is able to join assortment, beauty, strength and functionality. Quality items that can be used in order to set the most charming tables and buffets, but also in order to have a well-equipped kitchen. The easiest way to serve with charm any kind of dishes: from spaghetti to meat, fish, bread, vegetables, cheese and fruit. It is also indicated for tiny preparations such as sweets, olives and pickles. Nothing will unintentionally escape!



Forbice per verdure
Vegetables serving plier
Salad-/Gemüsezange
Pince à légumes
Pinza verduras

art. dim. cm.
52550-81 24



Forbice tutto servire
Serving plier
Servierzange
Pince à servir
Pinza servir

art. dim. cm.
52550-83 21,0
52550-84 26,5
52550-85 24,0



Forbice per torta
Pie plier
Kuchenzange
Pince à tarte
Pinza pasteles

art. dim. cm.
52550-80 28



Forbice per antipasti e dolci
Hors-d'oeuvres and pastry plier
Vorspeisen-/Pâtisseriezange
Pince à hors-d'oeuvres et pâtisserie
Pinza entremeses y pasteles

art. dim. cm.
52550-87 15
52550-89 20



Forbice per dolci
Pastry plier
Gebäckzange
Pince à pâtisserie
Pinza pasteles

art. dim. cm.
52550-88 18



Forbice uva
Grape scissor
Traubenschcher
Ciseaux à rasin
Tijeras uva

art. dim. cm.
52550-91 14,5



Molla per frutta
Fruit tong
Fruchtentzange
Pince à fruits
Pinza frutas

art. dim. cm.
52550-50 23,5



Molla per spaghetti
Spaghetti-tong
Spaghettizange
Pince à spaghetti
Pinza espagueti

art. dim. cm.
52550-73 21
52550-74 30



Molla per toast e dolci
Toast and pastry tong
Toast-/Gebäckzange
Pince à toast et tarte
Pinza pasteles y tostadas

art. dim. cm.
52550-77 21
52550-78 24
52550-79 30



Molla universale
Multipurpose tong
Universalzange
Pince universelle
Pinza universal

art. dim. cm.
52550-58 30



Molla tutto servire
Serving tong
Servierzange
Pince à servir
Pinza asados y verduras

art. dim. cm.
52550-68 21
52550-69 26
52550-70 30



Molla per pane e pasticceria
Bread and pastry tong
Brot-/Gebäckzange
Pince à pain et pâtisserie
Pinza pan y pasteles

art. dim. cm.
52550-62 18
52550-63 23
52550-64 26



Molla per lumache
Snail tong
Schneckenzange
Pince à escargots
Pinza caracoles

art. dim. cm.
52550-60 17



Molla per asparagi
Asparagus tong
Spargelzange
Pince à asperges
Pinza espárragos

art. dim. cm.
52550-66 23



Molla per ghiaccio
Ice tong
Eiszange
Pince à glace
Pinza hielo

art. dim. cm.
52550-56 17,5

TAVOLA TABLE TOP



Molla per zucchero
Sugar tong
Zuckerzange
Pince à sucre
Pinza azúcar

art. dim. cm.
52550-53 12



Molla per zucchero
Sugar tong
Zuckerzange
Pince à sucre
Pinza azúcar

art. dim. cm.
52550-54 12,5



Molla per ghiaccio
Ice tong
Eiszange
Pince à glace
Pinza hielo

art. dim. cm.
52550-55 18,5



Pala torta
Cake server
Tortenheber
Pelle à gâteau
Pala tarta

art. dim. cm.
52550-02 30



Coltello panettone
Panettone knife
Tortenmesser
Couteau à gâteau
Cuchillo tarta

art. dim. cm.
52550-34 32



Forchetta a servire
Serving fork
Serviergabel
Fourchette à servir
Tenedor servir

art. dim. cm.
52550-11 29,5
52550-12 26,0
52550-23 39,0



Cucchiaio a servire
Serving spoon
Servierlöffel
Cuiller à servir
Cuchara servir

art. dim. cm.
52550-13 30,0
52550-14 25,5
52550-22 39,0



Cucchiaio a servire forato
Serving spoon perforated
Servierlöffel, perforiert
Cuiller à servir perforée
Cuchara servir, perforada

art. dim. cm.
52550-24 39,0
52550-25 25,5
52550-26 30,0



Mestolo
Ladle
Schöpfer
Louche
Cazo

art. dim. cm.
52550-01 25,5



Coppino salsa
Sauce ladle
Dressingschöpfer
Louche à sauce
Cazillo salsas

art. dim. cm.
52550-20 16



Coppino forato
Perforated sauce ladle
Dressingschöpfer, gelocht
Louche à sauce percée
Cazillo, perforado

art. dim. cm.
52550-21 16,5



Forchettone spaghetti
Spaghetti serving fork
Spaghettivorlegegabel
Fourchette à servir spaghetti
Tenedor servir espagueti

art. dim. cm.
52550-15 28,5



Cucchiaio risotto
Rice ladle
Reislöffel
Cuiller à risotto
Cuchara arroz

art. dim. cm.
52550-16 28



Forchettone
Meat fork
Tranchiergabel
Fourchette
Tenedor

art. dim. cm.
52550-30 32



Coltello arrosto
Roast beef knife
Tranchiermesser
Couteau à rôtis
Cuchillo roastbeef

art. dim. cm.
52550-33 32



Forchetta servire pesce
Fish serving fork
Fischvorlegegabel
Fourchette à servir poisson
Tenedor servir pescado

art. dim. cm.
52550-41 25



Coltello servire pesce
Fish serving knife
Fischvorlegemesser
Couteau à servir poisson
Cuchillo servir pescado

art. dim. cm.
52550-42 25



Spatolina burro, set 6 pz
Butter spreader, 6 pcs set
Butterstreicher, 6 Stk
Tarnineur, 6 pcs
Palita mantequilla, 6 piezas

art. dim. cm.
52550-37 16,5



Cucchiaino sale
Salt spoon
Salzlöffel
Cuiller à sel
Cucharita para sal

art. dim. cm.
52550-17 6,5



Cucchiaio parmigiano
Parmesan spoon
Parmesanlöffel
Cuiller à parmesan
Cucharita parmesano

art. dim. cm.
52550-18 12,5



Cucchiaino moka, set 12 pz
Moka spoon, 12 pcs set
Mokkalöffel
Cuiller à moka
Cucharita moka

art. dim. cm.
62550B28 12,5



Cucchiaino moka, set 12 pz
Moka spoon, 12 pcs set
Mokkalöffel
Cuiller à moka
Cucharita moka

art. dim. cm.
62550B30 12,5



Forchettina aperitivi, set 12 pz
Party fork, 12 pcs set
Party-Gabel
Fourchette apéro
Tenedor party

art. dim. cm.
62550B27 12,5



Forchettina aperitivi, set 12 pz
Party fork, 12 pcs set
Party-Gabel
Fourchette apéro
Tenedor party

art. dim. cm.
62550B29 12,5



Spatolina, set 12 pz
Spreader, 12 pcs set
Butterstreicher, 12 Stk
Tarnineur, 12 pcs
Palita, 12 piezas

art. dim. cm.
62550B31 12,5
62550B32 12,5



Cucchiaio bibita, set 6 pz
Ice tea spoon, 6 pcs set
Limonadenlöffel
Cuillère à soda
Cuchara refresco

art. dim. cm.
52550-36 19,5



TAVOLA TABLE TOP



Forchettina ostriche, set 6 pz
Oyster fork, 6 pcs set
Austerngabel, 6 Stk.
Fourchette à huîtres, 6 pcs
Tenedor ostras, 6 piezas

art. dim. cm.
52550-43 14



Forchetta per lumache
Escargot fork
Schneckenabel
Fourchette à escargots
Tenedor caracoles

art. dim. cm.
52550-19 14



Cucchiaino bibita, set 6 pz
Ice tea spoon, 6 pcs set
Limonadenlöffel
Cuillère à soda
Cuchara refresco

art. dim. cm.
41605-25 25



Cucchiaino ghiaccio
Ice spoon
Eislöffel
Cuillère à glace
Cuchara hielo

art. dim. cm.
52550-04 22



Cucchiaino salsa
Dressing spoon
Saucenlöffel
Cuillère à sauce
Cuchara salsa

art. dim. cm.
52550-06 22



Cucchiaino monoporzione
Monoportion spoon
Monoporzion-Löffel
Cuillère monoportion
Cuchara monoporción

art. dim. cm.
52550-03 9,5
52550-07 12



Forchetta monoporzione
Monoportion fork
Monoporzion-Gabel
Fourchette monoportion
Tenedor monoporción

art. dim. cm.
52550-05 9,5



Forchetta monoporzione
Monoportion fork
Monoporzion-Gabel
Fourchette monoportion
Tenedor monoporción

art. dim. cm.
52550-09 12

COMPLEMENTI SERVING ITEMS



TAVOLA TABLE TOP



P

Caraffa termica, inox
Insulated beverage server, s/s
Thermokanne, Edelstahl Rostfrei
Pot isotherme, inox
Jarra térmica, inox

art.	lt.
41646-06	0,6
41646-10	1,0
41646-15	1,5
41646-20	2,0



P

Caraffa termica, inox
Insulated beverage server, s/s
Thermokanne, Edelstahl Rostfrei
Pot isotherme, inox
Jarra térmica, inox

art.	lt.
41650-03	0,3
41650-06	0,6
41650-10	1,0
41650-13	1,3



P

Caraffa termica, inox
Insulated beverage server, s/s
Thermokanne, Edelstahl Rostfrei
Pot isotherme, inox
Jarra térmica, inox

art.	lt.	art.	lt.
41650B03	0,3	41650R03	0,3
41650B06	0,6	41650R06	0,6
41650B10	1,0	41650R10	1,0
41650B13	1,3	41650R13	1,3



P

Caraffa termica, inox
Vacuum jug, stainless steel
Termokanne, 18-10 Edelstahl
Pot isothermique, inox
Jarra térmica, inox

art.	lt.
42401-10	1,0
42401-15	1,5
42401-20	2,0



P

Caraffa termica, inox
Vacuum jug, stainless steel
Termokanne, 18-10 Edelstahl
Pot isothermique, inox
Jarra térmica, inox

art.	lt.
42402-06	0,6
42402-10	1,0
42402-15	1,5
42402-20	2,0



Caffettiera pressa filtro, inox
French press, stainless steel
Kaffeebereiter, Edelstahl Rostfrei
Cafetière à piston, inox
Cafetera, inox

art.	ml.
41649-03	350
41649-06	600



N

Caraffa acrilico
Juice pitcher, acryl
Saftkanne, Acryl
Carafe à jus de fruits, acrilique
Jarra zumo, acrílico

art.	dim. cm.	h.	lt.
44995-25	23x13	27	2,5

Con tubo ghiaccio e camera frutta.
Contenuto con tubo 2,2 lt.
With ice-tube and fruit chamber, content with tube 2,2 liters.



Caraffa, MS
Juice pitcher, MS
Saftkanne, MS
Carafe à jus de fruits, MS
Jarra zumo, MS

art.	ø cm.	h.	lt.
44992-03	26	29	3

Antiurto e antigraffio, non idoneo al lavaggio in lavastoviglie, resistente fino a +85°C.
Shockproof, scratchproof, no dishwasher safe, heat resistant up to +85°C.



P

Caraffa, MS
Juice pitcher, MS
Saftkanne, MS
Carafe à jus de fruits, MS
Jarra zumo, MS

art.	ø cm.	h.	lt.
44992-02	16,5	26	2



P

Caraffa, polycarbonato
Water jug, PC
Wasserkrug, PC
Crûche à eau, PC
Jarra, PC

art.	ø cm.	h.	lt.
44999-09	10	15	0,9
44999-16	12	20	1,6



N

Caraffa, polycarbonato
Juice pitcher, PC
Saftkanne, PC
Carafe à jus de fruits, PC
Jarra zumo, PC

art.	lt.
44871-30	1,0
44871-31	coperchio / lid

Impilabile. Coperchio in PP.
Stackable. PP lid.



N

Caraffa con coperchio, polycarbonato
Juice pitcher with lid, PC
Saftkanne mit Deckel, PC
Carafe à jus de fruits avec couvercle, PC
Jarra zumo con tapa, PC

art.	lt.
44999-25	1,25



N

Caraffa vetro
Juice pitcher, glass
Glas-Saftkanne
Carafe à jus de fruits, verre
Jarra zumo, vidrio

art.	ø cm.	h.	lt.
44995-15	9,5	27	1,5

Coperchio inox. - Stainless steel lid.
-10°C/+110°C



N

Caraffa vetro
Juice pitcher, glass
Glas-Saftkanne
Carafe à jus de fruits, verre
Jarra zumo, vidrio

art.	ø cm.	h.	lt.
44995-14	16	27	1,4

Tappo apre e chiude automaticamente.
Piede cromato con eutettico, mantiene le
bevande refrigerate fino a 4 ore. - Spout
opens and closes automatically. Chromed
foot with cooler, keep drinks chilled up to 4
hours.



N

Caraffa vetro
Juice pitcher, glass
Glas-Saftkanne
Carafe à jus de fruits, verre
Jarra zumo, vidrio

art.	ø cm.	h.	lt.
44995-10	9,5	29	1

Tappo versatore apre e chiude
automaticamente. - Spout opens and
closes automatically while serving.



Piattino bustine tè, inox, set 2 pz
Tea bag rests, s/s, 2-pcs set
Teebeutel-Ablagen, Edelstahl, 2-er Set
Plat pour sachets de thé, inox, 2 pcs
Platito para bolsitas de té, inox, 2 pcs

art.	dim. cm.	h.
42619-02	12,5x7	1



P

Passathé, inox
Tea strainer, stainless steel
Teesieb, Edelstahl Rostfrei
Passoire à thé, inox
Colador bola infusiones, inox

art.	ø cm.
42617-04	4,5
42617-05	5,0
42617-06	6,5
42617-07	7,5



Passathé, inox
Tea strainer, stainless steel
Teesieb, Edelstahl Rostfrei
Passoire à thé, inox
Colador de té, inox

art.	ø cm.
41530-07	7,5



Passathé, inox
Tea strainer, stainless steel
Teesieb, Edelstahl Rostfrei
Passoire à thé, inox
Colador de té, inox

art.	ø cm.
41529-05	5



Passathé, inox
Tea strainer, stainless steel
Teesieb, Edelstahl Rostfrei
Passoire à thé, inox
Colador de té, inox

art.	ø cm.
41530-05	5



Passathé, inox
Tea strainer, stainless steel
Teesieb, Edelstahl Rostfrei
Passoire à thé, inox
Colador de té, inox

art.	ø cm.
41530-11	5

TAVOLA TABLE TOP



Portatoast, inox
 Toast rack, stainless steel
 Toastständer, Edelstahl Rostfrei
 Support pour toast, inox
 Porta tostadas, inox

art.	dim. cm.	h.	pz/pcs.
41599-08	20x11	5,7	8



Portauovo, inox
 Egg cup, stainless steel
 Eierbecher, Edelstahl Rostfrei
 Coquetier, inox
 Soporte huevos, inox

art.	ø cm.
41598-00	8,5



Portauovo, melamina, set 4 pz
 Egg cup, melamine, set 4 pcs
 Eierbecher, Melamin, 4er set
 Coquetier, melamine, set 4 pcs
 Soporte huevos, melamine, set 4 pz

art.	ø cm.	h.
41597-04	8,5	2



Piani in ardesia naturale.

Eccellente immagazzinamento del freddo, la superficie è protetta da una speciale vernice alimentare idro/liporepellente. Non idonei al lavaggio in lavastoviglie. Gli angoli dei piani sono spezzati (anziché tagliati) per evidenziare la tipica struttura del materiale. Con piedini antiscivolo.

* Spessore ardesia. - Material thickness.

Natural slate trays.

Excellent coldness retention, sealed with clear vanish, food safe, waterproofed surface, oil and liquid repellent, not dishwasher proof. The edges of the trays are broken to show the typical structure of the natural material. With anti-slip feet.



Piano, GN 1/1
 Tray, GN 1/1
 Platte, GN 1/1
 Plaque, GN 1/1
 Placa, GN 1/1

art.	dim. cm.	mm(*)
41585-11	53x32,2	5-8



Piano, GN 1/2
 Tray, GN 1/2
 Platte, GN 1/2
 Plaque, GN 1/2
 Placa, GN 1/2

art.	dim. cm.	mm(*)
41585-12	32,5x26,5	4-7



Piano, GN 1/3
 Tray, GN 1/3
 Platte, GN 1/3
 Plaque, GN 1/3
 Placa, GN 1/3

art.	dim. cm.	mm(*)
41585-13	32,5x17,5	4-7



Piano, GN 1/4
 Tray, GN 1/4
 Platte, GN 1/4
 Plaque, GN 1/4
 Placa, GN 1/4

art.	dim. cm.	mm(*)
41585-24	26,5x16,5	4-7



Piano quadro
 Tray, square
 Platte, quadratisch
 Plaque carré
 Placa, cuadrada

art.	dim. cm.	mm(*)
41585-25	25x25	4-7
41585-30	30x30	4-7



Piano rettangolare
 Tray, rectangular
 Platte, rechteckig
 Plaque, rectangulaire
 Placa, rectangular

art.	dim. cm.	mm(*)
41585-45	45x30	4-7



Piano tondo
 Tray, round
 Platte, rund
 Plaque, circulaire
 Placa, redonda

art.	ø cm.	mm(*)
N 41586-22	22	4-7
N 41586-28	28	4-7
41586-33	33	4-7
41586-38	38	4-7



Set buffet 3 pz
 Buffet set 3 pcs
 Buffet-Set, 3-tlg.
 Buffet set 3 pcs
 Buffet set 3 pz

art.	ø cm.	mm(*)
41587-38	38	4-7



Piano quadro, set 4 pz
 Tray, square, set 4 pcs
 Platte, quadratisch, 4er set
 Plaque carré, set 4 pcs
 Placa, cuadrada, set 4 pz

art.	dim. cm.	mm(*)
41585-10	10x10	4-7



Vassoio con fori
 Tray with holes
 Platte mit Absätze
 Plat avec trous
 Placa con agujeros

art.	dim. cm.	ø hole	mm(*)	fori/holes
41585-01	25x12	3,5	4-7	1
N 41585-02	15x8	6,0	4-7	2
41585-03	28x10	3,5	4-7	3



Piatto con campana
 Tray with dome
 Platte mit Glashaube
 Plat avec cloche
 Bandeja y campana de cristal

art.	ø cm.	h.	mm(*)
41585-00	10,5	8	4-7

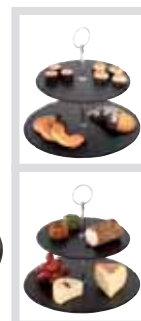

Alzata 2 piani
 2 tier tray
 2-stufige Etagère
 Présentoir 2 niveaux
 bandeja dos alturas

art.	ø cm.	h.
41587-25	25-20	24



Supporto girevole
 Revolving platter
 Servierplatt, drehbar
 Présentoir tournant
 soporte rotatorio

art.	ø cm.	h.
41587-32	32	2,5



TAVOLA TABLE TOP



Vassoio
Tray
Platte
Plat
Placa

41585-52 + 44843-24



41585-53 + 44843-12



41585-51 + 44842-30



41585-54 + 44842-35



art.	dim. cm.	mm[*]	per/fits
41585-51	24x15	5-8	44842-30
41585-52	47x10	5-8	44843-24
41585-53	26,5x20,5	5-8	44843-12
41585-54	32x12	4-7	44842-35



Set 12 vasetti con coperchio
Set 12 glasses and cover
Gläser mit Deckel, 12er Set
Set 12 verres avec couvercle
12 vasos con tapa

art.	ø cm.	h.	ml.
41589-08	6	5,5	80
41589-14	6	7,0	140



Set 12 vasetti con coperchio
Set 12 glasses and cover
Gläser mit Deckel, 12er Set
Set 12 verres avec couvercle
12 vasos con tapa

art.	ø cm.	h.	ml.
41589-16	6	8,0	160



Set 12 vasetti con coperchio
Set 12 glasses and cover
Gläser mit Deckel, 12er Set
Set 12 verres avec couvercle
12 vasos con tapa

art.	ø cm.	h.	ml.
41589-22	7	8,0	220



Set 6 bottigliette con coperchio
Set 6 bottles and cover
Flaschen mit Deckel, 6er Set
Set 6 bouteilles avec couvercle
6 botellas con tapa

art.	ø cm.	h.	ml.
41589-25	6,5	14,5	250



Set 6 bottigliette con coperchio
Set 6 bottles and cover
Flaschen mit Deckel, 6er Set
Set 6 bouteilles avec couvercle
6 botellas con tapa

art.	ø cm.	h.	ml.
41589-50	6,5	19	500



Set 6 bottigliette con coperchio
Set 6 bottles and cover
Flaschen mit Deckel, 6er Set
Set 6 bouteilles avec couvercle
6 botellas con tapa

art.	ø cm.	h.	lt.
41589-99	6,5	25,5	1,0



La forza del granito ed il calore del legno. Con piedini antiscivolo. - Granite stone durability and the beauty of wood. With non-slip feet.



Plancia, melamina
Tray, melamine
Tablett, Melamin
Plateau, melamine
Bandeja, melamine

art.	dim cm.	h.	GN
44471-11	53x32,5	1,5	1/1
44471-12	32,5x26,5	1,5	1/2
44471-13	32,5x17,6	1,5	1/3
44471-14	26,5x16,2	1,5	1/4
44471-24	53x16,2	1,5	2/4

Plancia, melamina
Tray, melamine
Tablett, Melamin
Plateau, melamine
Bandeja, melamine

art.	dim cm.	h.	GN
44472-11	53x32,5	1,5	1/1
44472-12	32,5x26,5	1,5	1/2
44472-13	32,5x17,6	1,5	1/3
44472-14	26,5x16,2	1,5	1/4
44472-24	53x16,2	1,5	2/4



Piani in melamina nera con una sofisticata e realistica finitura effetto ARDESIA che ne fanno una fantastica imitazione. Con piedini antiscivolo.
 Black melamine trays with a sophisticated and realistic slate look, a real great imitation. With non-slip foot.



Plancia, melamina
 Tray, melamine
 Tablett, Melamin
 Plateau, melamine
 Bandeja, melamine

Vassoio, melamina
 Tray, melamine
 Tablett, Melamin
 Plateau, melamine
 Bandeja, melamine



Ciotola, melamina
 Bowl, melamine
 Schüssel, Melamin
 Bassine, melamine
 Bol, melamina



art.	dim. cm.	h.	GN
44470-11	53x32,5	1	1/1
44470-12	32,5x26,5	1	1/2
44470-13	32,5x17,5	1	1/3
44470-14	26,5x16,5	1	1/4
44470-24	53x16,2	1	2/4

art.	dim. cm.	h.	GN
44470-53	53x32,5	1,5	1/1

art.	dim. cm.	h.	lt.
44470-04	25x25	12	3,8



Ogni pezzo è realizzato a mano quindi dimensioni, forma e finitura variano da pezzo a pezzo. Lavare a mano con acqua tiepida e sapone. Non mettere in ammollo. - Each piece is carefully crafted by hand therefore size, shape and finish may vary from piece to piece. Wash by hand with warm soapy water, do not to soak.



Tagliere, legno di ulivo
 Serving board, olive wood
 Servier-Brett Olive
 Planche de service en bois d'olivier
 Tabla en madera de olivo

Tagliere, legno di ulivo
 Serving board, olive wood
 Servier-Brett Olive
 Planche de service en bois d'olivier
 Tabla en madera de olivo

Tagliere, legno di ulivo
 Serving board, olive wood
 Servier-Brett Olive
 Planche de service en bois d'olivier
 Tabla en madera de olivo

art.	dim. cm.	h.
41320-25	25x17	1,5
41320-30	30x20,5	2,0
41320-35	35x24	2,0

art.	dim. cm.	h.	l. handle
41321-40	40x15	1,5	11
41321-44	44x20	2,0	12

art.	dim. cm.	h.	l. handle
41322-19	19x12,2	1,5	6
41322-25	25x16	1,5	8
41322-31	31x20	1,5	9

TAVOLA TABLE TOP



Ardesia Vintage Light



Plance in poliestere rinforzato, idoneo al contatto alimentare, lavabile in lavastoviglie. Finitura ruvida naturale ed elegante al tempo stesso. Possono essere utilizzate come piatto presentazione e come vassoi espositivi. Disponibili in 3 colorazioni. - *In reinforced polyester, suitable for food contact, dishwasher safe. Natural rough finish and elegant at the same time. They can be used as showplate and as presentation tray as well. Available in 3 colors.*



Plancia rettangolare LIGHT
Tray, rectangular
Serviertablett, rechteckig
Plateau rectangulaire
Bandeja rectangular

Plancia rettangolare VINTAGE
Tray, rectangular
Serviertablett, rechteckig
Plateau rectangulaire
Bandeja rectangular

Plancia rettangolare ARDESIA
Tray, rectangular
Serviertablett, rechteckig
Plateau rectangulaire
Bandeja rectangular

art.	dim. cm.	u. pack
41323-11	30x20	10
41323-12	40x20	10
41323-13	40x30	10
41323-14	60x40	10

art.	dim. cm.	u. pack
41323-21	30x20	10
41323-22	40x20	10
41323-23	40x30	10
41323-24	60x40	10

art.	dim. cm.	u. pack
41323-01	30x20	10
41323-02	40x20	10
41323-03	40x30	10
41323-04	60x40	10



Taglieri in melamina effetto legno di quercia e piani a servire in melamina finitura legno di quercia sbiancato. *Melamine serving boards oak wood effect and serving trays light oak look.*



Plancia, melamina
Tray, melamine
Tablett, Melamin
Plateau, melamine
Bandeja, melamine

Plancia, melamina
Tray, melamine
Tablett, Melamin
Plateau, melamine
Bandeja, melamine

Plancia, melamina
Tray, melamine
Tablett, Melamin
Plateau, melamine
Bandeja, melamine

art.	ø cm.	h.	l. handle
44474-30	30	1,5	12

art.	dim. cm.	h.	l. handle
44474-40	40x20	1,5	13

art.	dim. cm.	h.	l. handle
44474-48	48x20	1,5	13



Plancia, melamina
Tray, melamine
Tablett, Melamin
Plateau, melamine
Bandeja, melamine



art.	dim. cm.	h.	GN
44473-24	53x16,2	1,5	2/4



Plancia, melamina
Tray, melamine
Tablett, Melamin
Plateau, melamine
Bandeja, melamine



art.	dim. cm.	h.	GN
44473-12	32,5x26,5	1,5	1/2
44473-13	32,5x17,6	1,5	1/3
44473-14	26,5x16,2	1,5	1/4



Plancia, melamina
Tray, melamine
Tablett, Melamin
Plateau, melamine
Bandeja, melamine



art.	dim. cm.	h.	GN
44473-11	53x32,5	1,5	1/1



Vassoio Gourmet, melamina
Tray Gourmet, melamine
Tablett GOURMET, Melamin
Plateau, melamine
Bandeja, melamine



art.	dim. cm.	h.	ø holes
44466-30	30,5x9,5	2,5	4



Ciotoline Gourmet, melamina
Bowl gourmet, melamine
Schälchen GOURMET, Melamin
Bol, melamine
Bols, melamine



art.	ø cm.	h.	ml.
44466-07	7	6	50



Vassoio con ciotole melamina
Tray with melamine bowls
Tablett mit Melamin-Schalen
Plateau avec coupes melamine
Bandeja con copas melamina

art.	dim. cm.
44838-05	20x20



Vassoio con ciotole melamina
Tray with melamine bowls
Tablett mit Melamin-Schalen
Plateau avec coupes melamine
Bandeja con copas melamina

art.	dim. cm.
44838-07	29x20



Vassoio con ciotole melamina
Tray with melamine bowls
Tablett mit Melamin-Schalen
Plateau avec coupes melamine
Bandeja con copas melamina

art.	dim. cm.
44838-03	20x11



Senapiera, inox
Mustard cup, stainless steel
Senfschale, Edelstahl Rostfrei
Moutardier, inox
Mostacero, inox

art.	ø cm.
41564-07	7



Portapaté, inox
Paté cup, stainless steel
Terrine-Schale, Edelstahl Rostfrei
Terrine à foie gras, inox
Copa paté, inox

art.	ø cm.
41566-09	9



Coppa burro, inox
Butter cup, stainless steel
Butterservierer, Edelstahl Rostfrei
Coupe à beurre, inox
Copa mantequilla, inox

art.	ø cm.
41561-09	9

TAVOLA TABLE TOP



Coppa burro, inox
Butter cup, stainless steel
Butterservierer, Edelstahl Rostfrei
Coupe à beurre, inox
Copa mantequilla, inox

art. ø cm.
41563-07 7



Salsiera termica, acciaio inox
Insulated sauce boat, stainless steel
Thermo-Sauciere, doppelwandig, Edelstahl
Saucière isotherme, inox
Salsera termica, inox

art. dim. cm. h. lt.
41620-04 19x12,5 13 0,4



Salsiera, inox
Gravy boat with foot, stainless steel
Saucière mit Fuss, Edelstahl Rostfrei
Saucière sur pied, inox
Salsera con pie, inox

art. lt.
41615-01 0,15
41615-03 0,25
41615-05 0,45



Coppa soufflè
Ramekin
Ramekin
Ramequin
Fuente soufflè

art. ø cm. u. pack
61380-01 7 6

Arthur Krupp®
PORCELAIN



Coppa soufflè
Ramekin
Ramekin
Ramequin
Fuente soufflè

art. ø cm. u. pack
61380-04 15 1
61380-05 18 1
61380-06 23 1

Arthur Krupp®
PORCELAIN



Coppa creme brouléé
Creme brouléé bowl
Creme Brouléé Schale
Coupelle brouléé
Bol creme brouléé

art. ø cm. u. pack
61380-07 12 6

Arthur Krupp®
PORCELAIN



Zuppiera testa di leone
Soup bowl
Suppentasse Löwenkopf
Soupière tête de lion
Sopera cabeza de león

art. ø cm. cl.
44379-05 11 50



Ciotola per insalata
Salad bowl
Salatschüssel
Saladier
Bol para ensalada

art. ø cm. h.
44369-19 19,0 7,5
44369-21 21,0 8,0



Piatto ovale a barchetta
Oval dish
Platte, oval
Plat oval
Plato oval

art. dim. cm.
44368-24 24x15,5
44368-30 30x22
44368-35 35x26
44368-40 40x28,5
44368-45 45x32



Insalatiera esagonale
Hexagonal salad bowls
Salatschüssel, sechseckig
Saladier, hexagonal
Bol ensalada, hexagonal

art. ø cm. h.
44399-21 21 6,5
44399-23 23 9,5
44399-27 27 12,0



Insalatiera triangolare
Triangular salad bowl
Salatschüssel, dreieckig
Saladier, triangulaire
Bol ensalada, triangular

art. ø cm. h.
44370-20 20 10



Insalatiera, policarbonato
Salad bowl, PC
Salatschüssel, PC
Saladier, PC
Bol para ensalada, PC

art. ø cm. h. lt.
44950-15 15,2 5,0 0,6
44950-20 20,3 6,5 1,7
44950-25 25,4 8,0 3,0
44950-30 30,5 10,0 5,5
44950-38 38,1 12,5 10,6



Ciotola tonda
Round bowl
Schüssel, rund
Bassine ronde
Bol redonda

art.	ø cm.
42932-15	15,0
42932-30	30,5



Ciotola ovale
Oval bowl
Schüssel, oval
Bassine ovale
Bol oval

art.	dim. cm.
42931-19	19,5
42931-23	23,0



Insalatiera quadra, policarbonato
Square salad bowl, PC
Salatschüssel, quadratisch, PC
Saladier carré, PC
Bol para ensalada cuadrada, PC

art.	dim. cm.	h.	col.
44357-10	24x24	10	○
44357-15	24x24	15	○
44357B10	24x24	10	●
44357B15	24x24	15	●

Non idoneo al lavaggio in lavastoviglie. - No dishwasher safe.



PR

CESTI POLYRATTAN
Polyrattan baskets
PAGINA - Page: 171



Cesto pane, ovale, inox 18-10
Oval bread basket, 18-10 stainless steel
Brotchale, oval, 18-10 Edelstahl
Panier à pain, ovale, inox 18-10
Cesta pan, oval, acero 18-10

art.	dim. cm.	h.
66392-18	18x12	5
66392-22	22x16	5



Cesto pane, inox
Bread basket, stainless steel
Brotkorb, Edelstahl Rostfrei
Panier, inox
Cesta pan, inox

art.	ø cm.
41629-17	17,0
41629-20	20,0
41629-25	25,5



Cesto pane ovale, inox
Oval bread basket, stainless steel
Brotkorb, oval, Edelstahl Rostfrei
Panier ovale, inox
Cesta pan oval, inox

art.	dim. cm.
42956-19	19x15
42956-24	24,5x18
42956-28	28x21



Portagrissini, inox
Breadstick basket, stainless steel
Salzstangenkorb, Edelstahl Rostfrei
Panier à gressins, inox
Porta grissini, inox

art.	ø cm.	h.
41624-00	9,5	13,5



Tagliatartufi, inox
Truffle-slicer, stainless steel
Trüffelschneider, Edelstahl Rostfrei
Coupe-truffes, inox
Corta trufa, inox

art.	dim. cm.	lama/blade
48237-00	17x8,5	liscia/plain
48237-01	17x8,5	ondulata/waved



Servitartufi
Truffle server
Trüffel-Service
Service à truffes
Servidor de trufas

art.	dim. cm.	h.
48237-35	35x25	9



PR

Portaposate
Cutlery dispenser
Besteck-Ablage
Panier à couverts
Cesta portacubiertos

art.	dim. cm.	h.
42584-02	27x10	4,5



PR

Portaposate/grissini, POLYRATTAN
Cutlery/breadstick basket
Besteck-/Salzstangenkorb
Panier à couverts/gressins
Cesta cubiertos/grissini

art.	ø cm.	h.
42584-01	12	15



PR

Portaposate, GN 1/1
Cutlery dispenser, GN 1/1
Besteckkorb, GN 1/1
Panier à couverts, GN 1/1
Cesta portacubiertos GN 1/1

art.	dim. cm.	h.
42584-04	53x32,5	10



Portaposate, PP
Cutlery dispenser
Besteckbehälter
Bac à couverts
Dispensador de cubiertos

N

art. 42584-05 dim. cm. 53x32,5 h. 9



Portaposate, PP
Cutlery dispenser
Besteck-Korb
Panier à couverts
Cesta portacubiertos

N

art. 42584-06 ø cm. 26x18 h. 15



Portaposate, PP
Cutlery dispenser
Besteck-Korb
Panier à couverts
Cesta portacubiertos

N

art. 42584-07 ø cm. 26x18 h. 15



Set spargisale/pepe, inox
Salt/pepper shaker set, stainless steel
Salz- und Pfefferstreuer-Set, Edelstahl Rostfrei
Set salière et poivrier, inox
Juego 2 piezas sal y pimienta, inox

art. 42924-02 ø cm. 5 h. 6,5



Set 4 pz spargisale/pepe, inox
Small shaker, 4 pcs set, stainless steel
Ministreuer, Edelstahl Rostfrei
Set 4 pièces salière et poivrier, inox
Juego de 4 piezas bodegas pequeñas, inox

art. 42925-04 ø cm. 3,5 h. 4



Set 12 pz spargisale/pepe a 3 fori, inox
Salt/pepper shaker, 12 pcs set, s/s
Allzweckstreuer, 12er Set, Edelstahl
Set 12 pièces salière et poivrier, inox
Juego 12 piezas dosificador, inox

art. 42926-12 ø cm. 3 h. 9



P

Spargisale/pepe cromato
Salt/pepper shaker, chrome top
Salz-/Pfefferstreuer, verchromt
Salière/poivrier, chromé
Salero/pimentero, cromado

art. 42928-00 ml. 45



P

Macinasale/pepe, inox
Salt/pepper mill, stainless steel
Salz/Pfeffermühle, Edelstahl Rostfrei
Moulin à sel/poivre, inox
Molinillo sal/pimienta, inox

art. 42930S00 h. cm. 15,5
42930P00 15,5



P

Set sale e pepe, inox
Condiment set, stainless steel
Menage, 2-teilig, Edelstahl Rostfrei
Ménagère, inox
Servicio de mesa, 2 piezas, inox

art. 42927-02 dim. cm. 3x3 h. 5



P

Nebulizzatore olio/acetato, inox
Oil/vinegar sprayer, stainless steel
Oel/Essig-Spray, Edelstahl Rostfrei
Atomiseur à huile/vinaigre, inox
Aerosol para aceite/vinagre, inox

art. 41635-00 h. cm. 19 ml. 150 oil
41635-01 19 150 vinegar



Porta olio/acetato, inox
Oil and vinegar stand, stainless steel
Essig u. Öl-Stand, Edelstahl Rostfrei
Porte huile et vinaigre, inox
Soporte para aceite y vinagre, inox

art. 66362-02 dim. cm. 12,5x6 h. 27



Porta olio/acetato, inox
Oil and vinegar stand, stainless steel
Essig u. Öl-Stand, Edelstahl Rostfrei
Porte huile et vinaigre, inox
Soporte para aceite y vinagre, inox

art. 41636-25 dim. cm. 13x7 h. 30 ml. 250
41636-50 14,5x8,5 35 500



N

Servizio oliera, 4 pezzi, inox 18/8
Condiment set, 4 pcs, stainless steel
Menage, 4-teilig, Edelstahl Rostfrei
Ménagère, 4 pièces, inox
Servicio de mesa, 4 piezas, inox

art.	dim. cm.	h.
41638-04	17,5x10,5	23



N

Servizio oliera, 2 pezzi, inox 18/8
Condiment set, 2 pcs, stainless steel
Menage, 2-teilig, Edelstahl Rostfrei
Ménagère, 2 pièces, inox
Servicio de mesa, 2 piezas, inox

art.	dim. cm.	h.
41638-02	14,5x8,5	23



N

Set sale, pepe, stecchi, inox 18/8
Condiment set, 3-pcs stainless steel
Menage, 3-teilig, Edelstahl Rostfrei
Ménagère, 3 pièces, inox
Servicio de mesa, 3 piezas, inox

art.	ø cm.	h.
41638-13	10,5	16

Con tappo versatore antigoccia in polietilene. - With non drip - PE nozzle spout.



N

Set sale e pepe, inox 18/8
Condiment set, 2-pcs stainless steel
Menage, 2-teilig, Edelstahl Rostfrei
Ménagère, 2 pièces, inox
Servicio de mesa, 2 piezas, inox

art.	dim. cm.	h.
41638-12	10,5x6,5	16



N

Formaggiera, inox 18/8
Cheese jar, stainless steel
Käsedose, Edelstahl Rostfrei
Fromagère, inox
Quesera, inox

art.	ø cm.	h.
41638-01	10,5	7



Spargiformaggio, inox
Cheese shaker, stainless steel
Käsestreuer, Edelstahl Rostfrei
Poudreuse à fromage, inox
Quesera, inox

art.	cl.
42921-00	36



N

Portacondimenti, legno
Table Caddy
Tisch-Caddy
Caddy de table
Caddy de mesa

art.	dim. cm.	h.
41639-25	25x15	18



Fermatovaglia, set 4 pz
Table-cloth clips, 4 pcs set
Tischtuch Klammer, 4-Tlg
Pincas à nappe, 4 pièces
Pinzas para mantel, 4 piezas

art.
42953-04



Legatovagliolo, inox
Napkin holder, stainless steel
Serviettenring, Edelstahl Rostfrei
Porteserviette, inox
Servilletero, inox

art.
42955-00



RUNNER - RUNNERS

Materiale: 50% Poliestere - 50% Cloruro di polivinile

Material: 50% polyester - 50% Polyvinyl chloride



Beige

art.	dim. cm.
42950-92	42x180

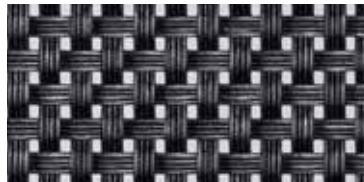

Nero
Black

art.	dim. cm.
42950-93	42x180



Marrone
Brown

art.	dim. cm.
42950-94	42x180

TOVAGLIETTE - TABLE MATS



Melange chiaro
Light melange

art.	dim. cm.	u.pack
42950-01	42x33	6



Beige

art.	dim. cm.	u.pack
42950-02	42x33	6

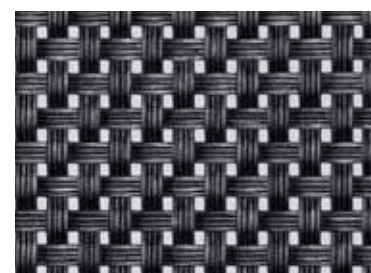

Nero
Black

art.	dim. cm.	u.pack
42950-03	42x33	6



Marrone
Brown

art.	dim. cm.	u.pack
42950-04	42x33	6



Beige / Grigio
Beige / Grey

art.	dim. cm.	u.pack
42950-05	42x33	6



Grigio
Grey

art.	dim. cm.	u.pack
42950-06	42x33	6



Crispy

art.	dim. cm.	u.pack
42950-07	42x33	6



Corallo
Coral

art.	dim. cm.	u.pack
42950-08	42x33	6

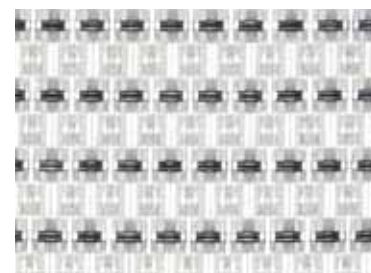

Gessato bianco
White pin-striped

art.	dim. cm.	u.pack
42950-09	42x33	6



Rechaud, inox
Plate warmer, stainless steel
Rechaud, 18-10 Edelstahl
Réchaud, inox
Réchaud, inox

art.	dim. cm.	h.
41569-33	33x18	6,5
41569-45	45x18	6,5

Piastra in alluminio. - Aluminum plate.

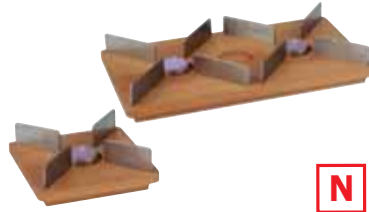

Rechaud, faggio/inox
Plate warmer, beechwood & s/s
Rechaud, Buche u. Edelstahl
Réchaud, hêtre/inox
Réchaud, madera/inox

art.	dim. cm.	h. cm.	kg.
44251-01	16x16	2,5	0,66
44251-03	36x20	2,5	1,84

N



Fornello crêpes suzettes, inox
Flambé burner, stainless steel
Flambier-Rechaud, Edelstahl Rostfrei
Réchaud à flamber, inox
Calentador para flambeaar, inox

art.	ø cm.	h.
56162-00	18,5	28



Padella crêpes, inox
Flambé pan, stainless steel
Flambierpfanne, Edelstahl Rostfrei
Poêle à crêpes, inox
Sartén para crêpes, inox

art.	ø cm.
56163-27	27
56163-30	30



Set fonduta formaggio
Cheese fondue set
Käsefondue-Service
Service à fondue fromage
Servicio para fondues queso

art.	ø cm.	h.
41311-00	22	17,5

P



Set fonduta bourguignonne
Bourguignonn fondue set
Bourguignonnefondue-Service
Service à fondue bourguignonne
Servicio para fondues bourguignonne

art.	ø cm.	h.
41312-00	20	18

P

La Fondue Bourguignonne è una tipica preparazione svizzera, che consiste nel rosolare dei cubetti di carne (preferibilmente controfiletto di manzo) nell'olio bollente e poi intingerli in varie salse. *Fondue Bourguignonne is a typical Swiss dish. Tender, thinly-sliced pieces of beef cubes (preferably sirloin) cooked in hot cooking oil then dipped in flavorful sauces.*



Supporto con 4 spiedini, inox
Stand with 4 spits, stainless steel
Träger mit 4 Fleischspießen, Edelstahl
Support avec 4 brochettes, inox
Soporte con 4 pinchos, inox

art.	ø cm.	h.
42417-22	22	46



Fonduta cioccolato
Chocolate fondue
Schokoladefondue
Fondue à chocolat
Fondue chocolate

art.	ø cm.	h.
42415-09	13	12

N



Set forchette, 6 pz
Dipping forks, 6 pcs
6 Stk. Fonduegäbelche
6 curettes à fondue
6 tenedores para fondue

art.	l. cm.
15428-06	24



Supporto con pietra ollare
Stand with grill stone
Träger mit Kochstein
Pierre à cuire avec support
Soporte con piedra

art.	dim. cm.	h.
41315-02	17x20	12

P



Supporto con pietra ollare
Stand with grill stone
Träger mit Kochstein
Pierre à cuire avec support
Soporte con piedra

art.	dim. cm.	h.
41315-04	44x20	12

P



Servizio raclette, per 1-2 persone
Raclette cheese service, for 1-2 persons
Raclette-Service
Fondeuse à fromage
Fundidora de queso

art.	dim. cm.	h.	kg.
42420-01	15x16	27	1,2



Servizio raclette, ¼ di forma
Raclette cheese service, ¼ shape
Raclette-Service
Fondeuse à fromage
Fundidora de queso

art.	dim. cm.	h.	kg.	V	W
42420-04	28x24	34	3	230	600



Servizio raclette, ½ forma
Raclette cheese service, ½ shape
Raclette-Service
Fondeuse à fromage
Fundidora de queso

art.	dim. cm.	h.	kg.	V	W
42420-08	26,5x53	40	3,7	230	900

Piatto tipico svizzero a base di formaggio Raclette servito con patate bollite e sottaceti, pancetta affumicata tagliata a fettine sottili, pepe, paprika e vino bianco.
Traditional Swiss dish made of Raclette cheese and boiled potatoes accompanied by pickled vegetables, thinly sliced smoked bacon, pepper, paprika and white wine.



P

Cocotte per molluschi, ferro smaltato
Mussel pot, enamel cast-iron
Muscheltopf, emailiertes Stahlblech
Casserole coquillage, émaillée
Cacerola para mejillones, esmaltada

art.	ø cm.	cap. kg
42414-05	13,5	0,5
42414-10	18,0	1,0
42414-15	20,0	1,5
42414-20	24,0	2,0



Cloche, inox
Dome cover, stainless steel
Speiseglocke, Edelstahl Rostfrei
Cloche, inox
Cubreplatos, inox

art.	dim. cm.	h.
41560-28	28	18



Raccoglibriciole
Crumb scraper
Krümelsammler
Ramasse miettes
Recogemigas

art.
42593-00



Raccoglibriciole a tubo, inox
Table crumbler, stainless steel
Krümelsammler, Edelstahl Rostfrei
Ramasse miettes, inox
Pala recogemigas, inox

art.	l. cm.
41679-23	23,5



Portarifiuti da tavola, plastica
Table garbage bin, plastic
Tischeimer, Kunststoff
Poubelle dé table, plastique
Papelera sobremesa, plástico

art.	ø cm.	h.
42959-13	12	18



Portarifiuti da tavola, inox
Table garbage bin, stainless steel
Tischeimer, 18-10 Edelstahl
Poubelle dé table, inox
Papelera sobremesa, inox

art.	ø cm.	h.
42959-12	12	17



P

Rompinoci
Nut-cracker
Nussknacker
Casse-noix
Cascanueces

art.
48211-00



P

Schiaccianoci, inox
Nut-cracker, stainless steel
Nussknacker, Edelstahl Rostfrei
Casse-noix, inox
Cascanueces, inox

art.	l. cm.
48210-00	16



Pinza aragosta, inox
Lobster cracker, stainless steel
Hummerzange, Edelstahl Rostfrei
Pince à homard, inox
Pinza bogavante, inox

art.	l. cm.
48239-00	20



Pinza aragosta, alluminio
 Lobster cracker, aluminum
 Hummerzange, Aluminum
 Pince à homard, alu
 Pinza bogavante, aluminio

art.
 48240-00



Taglia ricci di mare, inox
 Sea urchin cutter, stainless steel
 Seeigel-Messer, Edelstahl Rostfrei
 Coupe oursin, inox
 Cortador de erizo de mar, inox

art. l. cm. gr. ø cm
 48286-68 23 184 6



Stiletto aragosta, inox
 Lobster pick, stainless steel
 Hummergabel, Edelstahl Rostfrei
 Curette à homard, inox
 Tenedor bogavante, inox

art. l. cm.
 48238-00 20



Forchettine per aragosta, inox
 Lobster forks, stainless steel
 Hummergäbelchen, Edelstahl Rostfrei
 Currettes à homard, inox
 Tenedores bogavante, inox

art. l. cm. u.pack
 41594-18 18 5



Forchettine lumache, cromate
 Escargot picks, chromed
 Schneckengabel, verchromt
 Pic-escargots, chromés
 Pico-caracoles, cromado

art. u.pack
 41686-12 12



Spilli, inox
 Picks, stainless steel
 Stocher, Edelstahl Rostfrei
 Pic-bigorneaux, inox
 Pico-caracoles, inox

art. u.pack
 41594-12 12



Colonna luminosa per piatto frutti di mare
 Lightning column for oyster plate
 Lichtsäule für Austernplatte
 Socle lumineux pour plat à huîtres
 Columna luminosa para fuente de mariscos

art. ø cm. h.
 42979-00 30 21

Composto da un piatto inox ø30 cm. e colonna in PMMA, scatola luci-LED e telecomando. - Stainless steel base plate ø30 cm., PMMA column, LED-light box and remote control.



Piatto frutti di mare, inox
 Oyster plate, stainless steel
 Austernplatte, Edelstahl Rostfrei
 Plat à huîtres, inox
 Fuente de mariscos, inox

art. ø cm. h.
 42979-36 36 4,5
 42979-45 45 5,5

Sotto il piatto è fissato un elemento di centraggio che lo mantiene ancorato alla colonna luminosa. - The plate has a centering element which keeps it anchored to the column.



Piatto frutti di mare, inox
 Oyster plate, stainless steel
 Austernplatte, Edelstahl Rostfrei
 Plat à huîtres, inox
 Fuente de mariscos, inox

art. ø cm. h.
 41592-36 36 4
 41592-45 45 6



Supporto acciaio cromato
 Chrome plated wire holder
 Unterteil für Austernplatte, verchromt
 Support en fil chromé
 Sopoorte cromado para fuente mariscos

art. ø cm. h.
 41593-20 19-25 20



Vassoio frutti di mare, alluminio
 Oyster tray, aluminum
 Austernplatte, Aluminum
 Plat à huîtres, alu
 Fuente de mariscos, aluminio

art. ø cm. h.
 41591-32 32 6
 41591-36 36 6
 41591-40 40 6
 41591-45 45 6



Piatto frutti di mare, inox
 Oyster plate, stainless steel
 Austernplatte, Edelstahl Rostfrei
 Plat à huîtres, inox
 Fuente de mariscos, doble, inox

art. ø cm.
 41591-90 45-36

TAVOLA TABLE TOP



Piatto lumache, inox
Escargot dish, stainless steel
Schneckenplatte, Edelstahl Rostfrei
Plat à escargots, inox
Plato caracoles, inox

art.	pz/pcs
41687-06	6
41687-12	12



Coppa caviare, inox
Caviar cooler, stainless steel
Kaviarkühler, Edelstahl Rostfrei
Rafraîchisseur à caviar, inox
Copa caviar, inox

art.	ø cm.	h.
41562-18	18	5



Posate caviare, madreperla
Caviar flatware, mother of pearl
Kaviar-Bestecke, Perlmuttern
Couverts à caviar, nacre
Cubertería caviar, nácar

art.	l. cm.	
41518-00	11,5	spoon
41518-01	10,5	knife
41518-02	11,5	fork



Gancio da tavola, argentato
Table clip, silverplated
Tischbefestigung, All-Zweck, versilbert
Accroche-tout, argenté
Colgador de mesa multiuso, plateado

art.
31559-04



Supporto secchiello da tavola, cromato
Table clip for wine bucket, chrome
Tischbefestigung für Flaschenkühler, verchromt
Porte-seau à champagne, chromé
Soporte de mesa cubo champán, cromado

art.
41558-00
Per art.- For items: 41501-20 / 41502-20.



Secchiello vino, inox
Wine bucket, stainless steel
Sektkühler, Edelstahl Rostfrei
Seau à champagne, inox
Cubo champán, inox

art.	ø cm.	h.
41502-20	20	20



Secchiello champagne, alluminio
Champagne bucket, aluminum
Sektkühler, Aluminium
Seau à champagne, alu
Cubo champán, aluminio

art.	ø cm.	h.
41501-20	20	21



Secchiello vino, inox
Wine cooler, stainless steel
Weinkühler, Edelstahl Rostfrei
Seau à vin, inox
Cubo vino, inox

art.	ø cm.	h.	bottiglia-bottle
56120-18	18,5	16	1/2
56120-22	20,0	21	1
56120-24	24,0	22	2



Secchio vino bianco, inox
White wine cooler, stainless steel
Weissweinkühler, Edelstahl Rostfrei
Seau à vin blanc, inox
Cubo vino blanco, inox

art.	ø cm.	h.
56118-20	20	25



Portasecchiello, inox
Wine cooler stand, stainless steel
Ständer für Weinkühler, Edelstahl
Support pour seau à champagne, inox
Soporte para cubo, inox

art.	ø cm.	h.
41505-17	17,0	64,5
41505-19*	19,5	64,0



Glacette termica, inox
Bottle cooler, stainless steel
Flaschenkühler, Edelstahl Rostfrei
Rafraîchisseur à bouteille, inox
Enfriador isotérmico, inox

art.	ø cm.	h.
41504-09	9,5	22,5



Glacette termica, inox
Bottle cooler, stainless steel
Flaschenkühler, Edelstahl Rostfrei
Rafraîchisseur à bouteille, inox
Enfriador isotérmico, inox

art.	ø cm.	h.
41504-10	10	21

*Per secchio - For bucket: 56120-24.



Glacette termica, inox
 Bottle cooler, stainless steel
 Flaschenkühler, Edelstahl Rostfrei
 Rafrâchisseur à bouteille, inox
 Enfriador isotérmico, inox

art.	ø cm.	h.
41508-10	10	30



Glacette termica
 Bottle cooler
 Flaschenkühler
 Rafrâchisseur à bouteille
 Enfriador isotérmico

art.	ø cm.	h.
41504-12	12,5	22

Camicia in materiale plastico, finitura effetto metallo satinato. - *Noble plastic jacket in satin metal look.*



Termobottiglia, PS
 Bottle cooler, PS
 Flaschenkühler, PS
 Rafrâchisseur à bouteille, PS
 Enfriador isotérmico, PS

art.	ø cm.	h.
41504-11	10	22



Rinfresca bottiglie
 Bottle cooler
 Konferenzkühler
 Rafrâchisseur à bouteilles
 Cubo térmico para botellas

art.	ø cm.	h.	Col.
41509-23	23	15	○
41509B23	23	15	●



Esecuzione in inox e ABS, impilabile, fornito con eutettico, levacapsule e porta capsule. Per 6 bottiglie (fori ø 6,7 cm) da 0,25 fino a 0,5 litri. - *Made in plastic ABS and stainless steel cover, stackable, included bottle cooler, bottle opener, small cap bowl. 6 holes (ø 6,7 cm) for 0,25 to 0,5 liter bottles.*



Glacette termica, acrilico
 Double wall bottle cooler, acryl
 Flaschenkühler, doppelwand, Acryl
 Rafrâchisseur à double paroi, acrylique
 Enfriador isotérmico, acrílico

art.	ø cm.	h.
41507-01	9,5	23



Secchiello vino, acrilico
 Wine bucket, acryl
 Weinkühler, Acryl
 Seau à vin, acrylique
 Cubo para botella, acrílico

art.	ø cm.	h.
44946-01	20	25
44946B01	20	25



Secchiello vino, acrilico
 Wine bucket, acryl
 Weinkühler, Acryl
 Seau à vin, acrylique
 Cubo para botella, acrílico

art.	dim. cm.	h.
44946-02	30,5x21,5	26,5

TAVOLA TABLE TOP



Secchiello vino, acrilico
Wine bucket, acryl
Weinkühler, Acryl
Seau à vin, acrylique
Cubo para botellas, acrílico

art. ø cm. h.
44946-03 18,5 23,5



Secchiello vino, acrilico
Wine bucket, acryl
Weinkühler, Acryl
Seau à vin, acrylique
Cubo para botella, acrílico

art. dim. cm. h.
44946-06 26x20 28,5



Secchiello vino, acrilico
Wine bucket, acryl
Weinkühler, Acryl
Seau à vin, acrylique
Cubo para botella, acrílico

art. dim. cm. h.
44946B06 26x20 28,5



Cestino vino, argentato
Wine basket, silverplated
Weinkorb, versilbert
Panier à vin, argenté
Cesta para botella, plateado

art.
31509-01



Versavino a molla, inox
Wine holder, stainless steel
Weingestell, Edelstahl Rostfrei
Porte-Bouteille, inox
Soporte para botella, inox

art. ø cm.
41510-08 8



Versavino reversibile, inox
Wine holder, stainless steel
Weingestell, Edelstahl Rostfrei
Porte-bouteille, inox
Soporte para botella, inox

art. h. cm.
56123-00 17



P

Fermagocce, cromato
Wine drop catcher, chrome
Tropfenfänger, verchromt
Anti-gouttes, chromé
Anillo anti-goteo, cromado

art.
41511-00



Tastevin, inox
Wine taster, stainless steel
Weinprobenschale, Edelstahl Rostfrei
Tastevin, inox
Catador del vino, inox

art. ø cm.
41499-08 8,5



Scaldacognac, palladio
Cognac warmer, palladium
Cognacwärmer, Palladium
Réchaud à cognac, palladium
Calentador brandy, paladio

art. h. cm.
41678-14 14,5



Termometro vino
Wine thermometer
Wein-Thermometer
Thermomètre à vin
Termometro vino

art. dim. cm. h.
41498-04 17x6,5 2,5



Set vino, 3 pezzi
Wine kit, 3 pieces
Wein-Satz, 3 Stk.
Set à vin, 3 pièces
Juego vino, 3 piezas

art. dim. cm. h.
41498-02 17x13 2,5



Set vino, 3 pezzi
Wine kit, 3 pieces
Wein-Satz, 3 Stk.
Set à vin, 3 pièces
Juego vino, 3 piezas

art. dim. cm. h.
41498-03 19x10 2,5



Candeliere, argentato
Candle stick, silverplated
Kerzenleuchter, versilbert
Bougeoir, argenté
Candelabro, plateado

art.	ø cm.	h.
32931-02	10	20,5



Candelabro 3 luci, argentato
Candelabra 3-lights, silverplated
Kerzenleuchter, 3-flammig, versilbert
Chandelier 3 bougies, argenté
Candelabro 3 velas, plateado

art.	ø cm.	h.
32931-03	10	22,5



Candelabro 5 luci, argentato
Candelabra 5-lights, silverplated
Kerzenleuchter, 5-flammig, versilbert
Chandelier 5 bougies, argenté
Candelabro 5 velas, plateado

art.	ø cm.	h.
32931-05	10	24



Candeliere, argentato
Candle stick, silverplated
Kerzenständer, versilbert
Bougeoir, argenté
Candelabro 1 vela, plateado

art.	ø cm.	h.
32935-10	10	10
32935-22	10	22



Candelabro 5 luci, nichelato
Candelabra 5-lights, nickel-plated
Kerzenleuchter, 5-flammig, vernickelt
Chandelier 5 bougies, nickelé
Candelabro 5 velas, niquelado

art.	ø cm.	h.
42443-06	17	56
42443-08	24	78
42443-10	24	98



Candelabro 3 luci, argentato
Candelabra 3-lights, silverplated
Kerzenleuchter, 3-flammig, versilbert
Chandelier 3 bougies, argenté
Candelabro 3 velas, plateado

art.	ø cm.	h.
32935-03	11	25



Candelabro 5 luci, argentato
Candelabra 5-lights, silverplated
Kerzenleuchter, 5-flammig, versilbert
Chandelier 5 bougies, argenté
Candelabro 5 velas, plateado

art.	ø cm.	h.
32935-05	11	25



Candelabro 3 luci, argentato
Candelabra 3-lights, silverplated
Kerzenleuchter, 3-flammig, versilbert
Chandelier 3 bougies, argenté
Candelabro 3 velas, plateado

art.	ø cm.	h.
32936-03	13	37,5



Candelabro 5 luci, argentato
Candelabra 5-lights, silverplated
Kerzenleuchter, 5-flammig, versilbert
Chandelier 5 bougies, argenté
Candelabro 5 velas, plateado

art.	ø cm.	h.
32936-05	13	37,5

TAVOLA TABLE TOP



Portacandela, inox satinato, set 2 pz
Wind light, s/s, satin finish, 2-pcs set
Windlicht, Edelstahl mattiert, 2-er Set
Lampe à bougie, inox satin mat, 2 pcs
Porta-vela antiviento, acero satinado, 2 pcs

art.	ø cm.	h.
42939-15	5	15



Portacandela, inox satinato, set 2 pz
Wind light, s/s, satin finish, 2-pcs set
Windlicht, Edelstahl mattiert, 2-er Set
Lampe à bougie, inox satin mat, 2 pcs
Porta-vela antiviento, acero satinado, 2 pcs

art.	ø cm.	h.
42440-22	8	22



Lampada da tavolo, cromata
Table candle lamp, chrome-plated
Windlicht, Metall verchromt
Lampe à bougie, acier chromé
Lampara de mesa, acero cromado

art.	ø cm.	h.
42941-22	11	22
42941-32	11	32



Portacandela, inox satinato
Wind light, stainless steel satin finish
Windlicht, Edelstahl mattiert
Lampe à bougie, inox satin mat
Porta-vela antiviento, acero satinado

art.	ø cm.	h.
42441-01	9,5	15



Portacandela, inox satinato, set 2 pz
Wind light, s/s, satin finish, 2-pcs set
Windlicht, Edelstahl mattiert, 2-er Set
Lampe à bougie, inox satin mat, 2 pcs
Porta-vela antiviento, acero satinado, 2 pcs

art.	ø cm.	h.
42441-02	7,5	12,5



Vaso fiori, porcellana
Flower vase, porcelain
Blumenvase, Porzellan
Vase à fleurs, porcelaine
Florero, porcelana

art.	ø cm.	h.	kg.
42943-13	5	13	0,29



Vaso fiori, nichelato
Flower vase, nickel plated
Blumenvase, vernickelt
Vase à fleurs, nickelé
Florero, zinc-niquel

art.	ø cm.	h.
42942-16	4	16,5



Vaso fiori, inox
Flower vase, stainless steel
Blumenvase, Edelstahl Rostfrei
Vase à fleurs, inox
Florero, inox

art.	h. cm.
41628-15	15



Porta menù, inox
Menu stand, stainless steel
Speisekartenhalter, Edelstahl Rostfrei
Porte-menu, inox
Portamenús, inox

art.	dim. cm.	h.
42951-08	8x7	2



Supporto numero tavola, inox
Table number stand, stainless steel
Tischnummerständer, Edelstahl Rostfrei
Support numéro de table, inox
Soporte número de mesa, inox

art.	ø cm.	h.
42954-04	4	10



Supporto numero tavola, inox
Table number stand, stainless steel
Tischnummerständer, Edelstahl Rostfrei
Support numéro de table, inox
Soporte número de mesa, inox

art.	ø cm.	h.
42954-18	7,5	18,5
42954-29	7,5	29,0
42954-46	7,5	46,0



Supporto targhetta, inox
Card holder, stainless steel
Kartenhalter, Edelstahl Rostfrei
Porte-cartes, inox
Portatarjetas, inox

art.	dim. cm.	h.
42952-05	6x5	3



Targhetta da tavola, inox
Table stand, stainless steel
Tischaufsteller, Edelstahl Rostfrei
Plaque de table, inox
Placa de mesa, inox

art.	dim. cm.	h.	u.pack
42951-58	5,5x5	3,5	2



Targhetta da tavola, inox
Table stand, stainless steel
Tischaufsteller, Edelstahl Rostfrei
Plaque de table, inox
Placa de mesa, inox

art.	dim. cm.	h.	u.pack
42951-57	5,5x5	3,5	2



Targhette numeri, inox satinato
Table numbers, s/s satin finish
Tischnummernschild, Edelstahl mattiert
Plaquettes nombres, inox satin mat
Números de mesa, acero satinado

art.	dim. cm.	nr.	pz/pcs.
42958-00	5,3x4,5	1-12	12
42958-01	5,3x4,5	13-24	12
42958-02	5,3x4,5	25-36	12
42958-03	5,3x4,5	37-48	12
42958-04	5,3x4,5	49-60	12
42958-05	5,3x4,5	61-72	12



Simbolo per porta
Sign plate
Türsymbol
Plaque de porte
Placa para puerta

art.	ø cm.	
42958-28	16	SMOKING



Simbolo per porta
Sign plate
Türsymbol
Plaque de porte
Placa para puerta

art.	ø cm.	
42958-29	16	NO SMOKING



Targhetta da tavola, inox
Table stand, stainless steel
Tischaufsteller, Edelstahl Rostfrei
Plaque de table, inox
Placa de mesa, acero

art.	dim. cm.	h.	u.pack
42951-59	5,5x5	3,5	2

art.	ø cm.	
42958-11	7,5	LADIES
42958-12	7,5	GENTS
42958-13	7,5	LADIES/GENTS
42958-14	7,5	DISABLED
42958-15	7,5	WC
42958-18	7,5	PLEASE SIT
42958-16	7,5	SMOKING
42958-17	7,5	NO SMOKING
42958-19	7,5	COATS
42958-20	7,5	NO MOBILES
42958-23	7,5	PULL
42958-24	7,5	PUSH
42958-26	7,5	NO ENTRY



Pittrogrammi, inox
Sign plates, stainless steel
Türsymbol, Edelstahl Rostfrei
Pictogrammes, inox
Pictogramas, inox

Simbolo per porta
Sign plate
Türsymbol
Plaque de porte
Placa para puerta

art.	ø cm.	
42958-27	13	OPEN -CLOSED

Fronte retro. - Turnable.

Acciaio inox spazzolato, spessore 1 mm. stampa serigrafica nera, adesivo posteriore.
Stainless steel satin polished, material thickness 1 mm., black screenprint, self-adhesive back.

TAVOLA TABLE TOP



Campanella reception, inox
Reception bell, stainless steel
Receptionsschell, Edelstahl
Sonette de réception, inox
Timbre recepción, inox

art.	Ø cm.	h.
41390-00	8,5	6



Tagliasigari da tavola
Table cigar cutter
Zigarrenschneider
Coupe-cigares
Guillotina para puros

art.
48244-07

Modelli assortiti. - Assorted models.



Forbice sigari, inox
Cigar scissors, stainless steel
Zigarrenscherer, Edelstahl Rostfrei
Ciseaux à cigares, inox
Cortador para puros, inox

art.	dim. cm.
48245-10	10x5



Tagliasigari da tavola, inox
Table cigar cutter, stainless steel
Zigarrenschneider, Edelstahl Rostfrei
Coupe-cigares, inox
Guillotina para puros, inox

art.	dim. cm.
48242-09	9x4



Vetrina sigari
Cigar humidor
Zigarren-Vitrine
Vitrine à cigares
Vitrina para puros

art.	dim. cm.	h.
48245-75	30x24	14,5



Cofanetto per circa 40 sigari, con umidificatore, 1 separatore interno posizionabile a piacere, vassoio estraibile, igrometro esterno. - Cigar humidor with glass top, holds about 40 cigars, with hygrometer, humidifier, tray and removable divider.





Portasigaro con piattino, inox
 Cigar ashtray, stainless steel
 Aschenbecher mit Zigarrenhalter
 Cendrier à cigares, inox
 Cenicero para puros, inox

art. ø cm.
 48241-14 14,5



Posacenere, porcellana
 Ashtray, porcelain
 Aschenbecher, Porzellan
 Cendrier en porcelaine
 Cenicero de porcelana

art. ø cm.
 44366-10 10



Posacenere impilabile, inox
 Ashtray, stackable, stainless steel
 Aschenbecher, stapelbar, Edelstahl
 Cendrier empilable, inox
 Cenicero, inox

art. ø cm.
 48247-10 10



Posacenere impilabile, inox
 Ashtray, stackable, stainless steel
 Aschenbecher, stapelbar, Edelstahl
 Cendrier empilable, inox
 Cenicero, apilable, inox

art. ø cm.
 48248-16 16



Posacenere impilabile, inox
 Ashtray, stackable, stainless steel
 Aschenbecher, stapelbar, Edelstahl
 Cendrier empilable, inox
 Cenicero, apilable, inox

art. ø cm. h.
 48250-10 10 4,5



Posacenere impilabile, inox
 Ashtray, stackable, stainless steel
 Aschenbecher, stapelbar, Edelstahl
 Cendrier empilable, inox
 Cenicero, apilable, inox

art. ø cm. h.
 48250-12 12 4,5



Posacenere, cromato
 Ashtray, chrome plated
 Aschenbecher, Metall hartverchromt
 Cendrier, chromé
 Cenicero, cromado

art. ø cm. h.
 48249-13 13 10,5



Set 3 posaceneri impilabili
 3-piece ashtray set, stackable
 Satz 3 Stk Aschenbecher, stapelbar
 Set 3 pièces Cendrier empilable
 Juego 3 pz cenicero, apilable

art. ø cm. h. Col.
 48251-03 7,8 3 ●



Posacenere impilabile, antiscivolo
 Ashtray, stackable, non slip
 Aschenbecher, stapelbar
 Cendrier empilable
 Cenicero, apilable

art. ø cm. h. Col.
 48252-10 10 4,0 ○
 48252-12 12 4,3 ○



Posacenere impilabile, antiscivolo
 Ashtray, stackable, non slip
 Aschenbecher, stapelbar
 Cendrier empilable
 Cenicero, apilable

art. ø cm. h. Col.
 48252B10 10 4,0 ●
 48252B12 12 4,3 ●



Posacenere impilabile, antiscivolo
 Ashtray, stackable, non slip
 Aschenbecher, stapelbar
 Cendrier empilable
 Cenicero, apilable

art. ø cm. h. Col.
 48253-09 9,5 4 ○



Posacenere impilabile, antiscivolo
 Ashtray, stackable, non slip
 Aschenbecher, stapelbar
 Cendrier empilable
 Cenicero, apilable

art. ø cm. h. Col.
 48253B09 9,5 4 ●

PEUGEOT

MACINE
MILLS



MECCANISMI - MECHANISMS

PEPE - PEPPER



Il meccanismo è dotato di una doppia fila di denti elicoidali che catturano il grano, lo spingono verso il basso e lo bloccano per macinarlo perfettamente. Subisce un trattamento brevettato che protegge l'acciaio dalla corrosione pur mantenendo la sua affilatura e resistenza all'usura. Per ottenere i migliori risultati, si consiglia di utilizzare solo pepe in grani secchi da 5 mm o meno di diametro. Si possono macinare pepe verde, nero, e bianco. Le bacche rosse possono essere macinate solo se miscelate (max 15%) con altri grani di pepe. Semi di coriandolo secchi sono anch'essi adatti per il meccanismo macina pepe.

The pepper mechanism is equipped with a helix-shaped double row of teeth that guide and hold the peppercorns for a perfect grind. It has a patented treatment that protects the steel from corrosion while maintaining its sharpness and wear resistance. To get the best out of your Peugeot pepper grinding mechanism, we recommend to use peppercorns with a diameter of 5 mm (3/16") or less. Black, white and dry green peppercorns can be ground in Peugeot pepper mills. The pink berries can be ground only if in a blend (max 15% pink) with one of these other peppercorns. Dried coriander is also suitable for the pepper mechanism.

SALE - SALT



Il meccanismo per il sale Peugeot è disegnato per macinare sale marino grosso. Realizzato in acciaio inossidabile resiste alla corrosione provocata dal sale asciutto. Non usare con pepe ed altre spezie, con sale di mare umido o con fiore di sale (Guérande, Ré, Malton, sel rose...). Per ottimizzare la resa del meccanismo si consiglia di utilizzare sale con un diametro di 4 mm.

The Peugeot salt mechanism is designed to grind cooking salt. It is made of stainless steel and is not sensitive to salt corrosion. To get the best out of your Peugeot salt grinding mechanism, you should use: salt with a diameter of 4 mm (3/16") or dry coarse salt: dry sea salt or rock salt. Do not use for pepper or any other spice. Do not use with wet sea salt or flowers of salt, Guérande, Ré, Maldon, pink salt, etc.

SALE UMIDO - WET SEA SALT



Un innovativo sistema brevettato appositamente progettato per sale marino bagnato la cui consistenza naturale ed il contenuto di umidità non permettono l'uso di un comune macinasale. Il meccanismo assicura un'ottima macina, un'uscita costante, e una spirale che mescola il sale affinché non si attacchi. Esclusivo meccanismo di ceramica, Made in France.

A specially designed mill for wet sea salt. The natural consistency and moisture content do not allow the use of an ordinary salt mill. Innovative patented system for a high-performance grind without blockage even with very humid or compressed salt. This specific mechanism is composed of 3 stops ensuring both mechanism resistance and constant output, and an anti-clogging spiral which shuffles the salt in the reservoir. Peugeot ceramic exclusive mechanism, Made in France.

PEPERONCINO - CHILI PEPPER



Questo meccanismo è un prodotto esclusivo Peugeot. Il modello brevettato ha un sistema di pre-taglio e un meccanismo che permettono di macinare il peperoncino essiccato. Come il macinapepe, il meccanismo subisce un trattamento brevettato che protegge l'acciaio dalla corrosione pur mantenendo la sua affilatura e resistenza all'usura.

The chili pepper mechanism is a Peugeot exclusive product. This patented model has a pre-cutting system and a mechanism that grinds dry chili pepper. Like the pepper grinder it has a patented treatment that protects the steel from corrosion while maintaining its sharpness and wear resistance.

NOCE MOSCATA - NUTMEG



La macina è dotata di una doppia lama per grattugiare in acciaio inox e di un robusto dischetto uncinato che permette di grattugiare l'intera noce molto finemente.

The Peugeot nutmeg mill is equipped with a double stainless steel blade/grater and a strong claw which enables the nutmeg to be very finely ground.

IMPOSTAZIONE DELLA MACINA - ADJUSTABLE GRINDING SYSTEM

PER MACINE MANUALI ED ELETTRICHE - FOR ELECTRIC OR MANUAL MILLS

Sistema brevettato che permette una regolazione predefinita della macinatura. 6 Livelli per il pepe e 6 Livelli per il sale. Facile: basta ruotare l'anello alla base della macina e selezionare una delle posizioni, ognuna corrisponde ad una determinata grana.

Patented system that enables precise grind adjustment settings. 6 pre-defined levels of grind for pepper and 6 for salt. Easy: just rotate the ring at the base of the mill and select one of the positions, each corresponding to a specific grain.

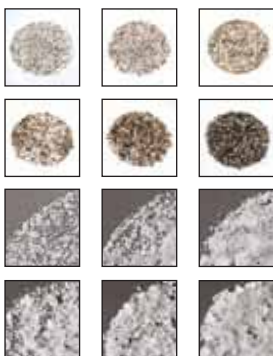

REGOLAZIONE CLASSICA - CLASSIC ADJUSTABLE SYSTEM

Negli apparecchi elettrici la rotella di regolazione si trova sotto il meccanismo di macinatura. Negli apparecchi manuali la regolazione si effettua ruotando il dado/pomolino. Ruotare in senso orario per ottenere una macinatura più fine, in senso antiorario per ottenere una macinatura più grossa.

Thumbwheel grind adjustment on electric grinders is found below the grinding mechanism. Grind adjustment nut on manual mills, turn the nut. Clockwise to obtain a finer grind, counter-clockwise to obtain a coarser grind.





ALASKA - Duo, macina pepe/sale, elettrici
Duo, electric pepper/salt mill
Duo, Pfeffer-/Salzmühle
Duo, moulin à poivre/sel
Duo, molinillo pimienta/sal

art. h. cm.
42660-02 17

Polycarbonato/Acrylic. Forniti con 6 batterie e lampadina.
Polycarbonate/Acrylic. Fitted with: 6 batteries - spare bulb.



ELIS SENSE - Macina pepe/sale
Pepper/salt mill
Pfeffer-/Salzmühle
Moulin à poivre/sel
Molinillo pimienta/sal

art.-P art.-S h. cm.
42785S20 42786S20 20

Inox. Dotati di led e forniti con 6 batterie (si possono utilizzare anche batterie ricaricabili), vassoietto e fiala dosatrice con imbuto. - *Stainless steel. Fitted with LED, 6 batteries (can also work with rechargeable batteries), a small dish and a pre-measured spice vial with funnel.*



ELIS RICARICABILE - Macina pepe/sale
Pepper/salt mill
Pfeffer-/Salzmühle
Moulin à poivre/sel
Molinillo pimienta/sal

art.-P art.-S h. cm.
42785R20 42786R20 20

Inox. Forniti con carica batterie, vassoietto e lampadina.
Stainless steel. Fitted with: rechargeable battery - tray - spare bulb.



ONYX - Macina pepe/sale
Pepper/salt mill
Pfeffer-/Salzmühle
Moulin à poivre/sel
Molinillo pimienta/sal

art.-P art.-S h. cm.
42800P20 42800S20 20

Soft touch. Forniti con 6 batterie e lampadina. - *Soft touch. Fitted with: 6 batteries - tray - spare bulb.*



ZEPHIR - Macina pepe/sale
Pepper/salt mill
Pfeffer-/Salzmühle
Moulin à poivre/sel
Molinillo pimienta/sal

art.-P art.-S h. cm.
42692B14 42693B14 14

ABS imitazione inox. - Soft touch. Forniti con 4 batterie. - *ABS stainless steel look. Fitted with: 4 batteries.*



ZELI - Macina pepe/sale
Pepper/salt mill
Pfeffer-/Salzmühle
Moulin à poivre/sel
Molinillo pimienta/sal

art.-P art.-S h. cm.
42801P14 42801S14 14

ABS imitazione inox. Forniti con 4 batterie. - *ABS stainless steel look. Fitted with: 4 batteries.*



**TAVOLA TABLE TOP
PEUGEOT MACINE MILLS**



BISTRO - Macina pepe/sale
Pepper/salt mill
Pfeffer-/Salzmühle
Moulin à poivre/sel
Molinillo pimienta/sal

art.-P	art.-S	h. cm.
42701-10	42703-10	10

Faggio - naturale.
Beech wood - natural.



BISTRO - Macina pepe/sale
Pepper/salt mill
Pfeffer-/Salzmühle
Moulin à poivre/sel
Molinillo pimienta/sal

art.-P	art.-S	h. cm.
42702-10	42704-10	10

Faggio - cioccolato.
Beech wood - chocolate.



BISTRO - Macina pepe/sale
Pepper/salt mill
Pfeffer-/Salzmühle
Moulin à poivre/sel
Molinillo pimienta/sal

art.-P	art.-S	h. cm.
42702P10	42704S10	10

Faggio - nero opaco.
Beech wood - black matt.



BISTRO - Macina pepe/sale
Pepper/salt mill
Pfeffer-/Salzmühle
Moulin à poivre/sel
Molinillo pimienta/sal

art.-P	art.-S	h. cm.
42701P10	42703S10	10

Faggio - bianco opaco.
Beech wood - white matt.



BISTRO ANTIQUE - Macina pepe/sale
Pepper/salt mill
Pfeffer-/Salzmühle
Moulin à poivre/sel
Molinillo pimienta/sal

art.-P	art.-S	h. cm.
42705P10	42705S10	10

Faggio. - Beech wood.



HOSTELLERIE - Macina pepe
Pepper mill
Pfeffermühle
Moulin à poivre
Molinillo pimienta

art.	h. cm.
42741-22	22

Faggio - naturale.
Beech wood - natural.

42742-22	22
----------	----

Faggio - cioccolato.
Beech wood - chocolate.



PARIS ANTIQUE - Macina pepe/sale
Pepper/salt mill
Pfeffer-/Salzmühle
Moulin à poivre/sel
Molinillo pimienta/sal

art.-P	art.-S	h. cm.
42749P18	42749S18	18
42749P22	42749S22	22
42749P30		30

Faggio. - Beech wood.



PARIS - Macina pepe/sale
Pepper/salt mill
Pfeffer-/Salzmühle
Moulin à poivre/sel
Molinillo pimienta/sal

art.-P	art.-S	h. cm.
42746P12		12
42746P18	42746S18	18
42746P22	42746S22	22
42746P30	42746S30	30
42746P40		40
42746P50		50
42746P80		80

Faggio - cioccolato.
Beech wood - chocolate.



PARIS - Macina pepe/sale
Pepper/salt mill
Pfeffer-/Salzmühle
Moulin à poivre/sel
Molinillo pimienta/sal

art.-P	art.-S	h. cm.
42747P12	42747S12	12
42747P18	42747S18	18

Faggio - laccato nero.
Beech wood - black lacquered.



TAVOLA TABLE TOP



PARIS - Macina pepe/sale
Pepper/salt mill
Pfeffer-/Salzmühle
Moulin à poivre/sel
Molinillo pimienta/sal



art.-P	art.-S	h. cm.
42665P12	42665S12	12
42665P18	42665S18	18
42665P22	42665S22	22
42665P27	42665S27	27
42665P30	42665S30	30
42665P40	42665S40	40

Faggio - naturale.
Beech wood - natural.



PARIS - Macina pepe/sale
Pepper/salt mill
Pfeffer-/Salzmühle
Moulin à poivre/sel
Molinillo pimienta/sal



art.-P	art.-S	h. cm.
42667P12	42667S12	12
42667P18	42667S18	18
42667P22	42667S22	22
42667P30	42667S30	30

Faggio - laccato nero.
Beech wood - black lacquered.



PARIS - Macina pepe/sale
Pepper/salt mill
Pfeffer-/Salzmühle
Moulin à poivre/sel
Molinillo pimienta/sal

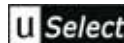

art.-P	art.-S	h. cm.
42666P12	42666S12	12
42666P18	42666S18	18
42666P22	42666S22	22
42666P27	42666S27	27
42666P30	42666S30	30
42666P40	42666S40	40

Faggio - cioccolato.
Beech wood - chocolate.



PARIS - Macina pepe/sale
Pepper/salt mill
Pfeffer-/Salzmühle
Moulin à poivre/sel
Molinillo pimienta/sal



art.-P	art.-S	h. cm.
42664P12	42664S12	12
42664P18	42664S18	18
42664P22	42664S22	22
42664P30	42664S30	30
42664P40	42664S40	40

Faggio - laccato bianco.
Beech wood - white lacquered.



PARIS - Macina pepe/sale
Pepper/salt mill
Pfeffer-/Salzmühle
Moulin à poivre/sel
Molinillo pimienta/sal

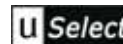

art.-P	art.-S	h. cm.
42668P12	42668S12	12
42668P18	42668S18	18
42668P22	42668S22	22
42668P30	42668S30	30
42668P40	42668S40	40

Faggio - laccato rosso.
Beech wood - red lacquered.

**TAVOLA TABLE TOP
PEUGEOT MACINE MILLS**



CHÂTEL - Macina pepe/sale
Pepper/salt mill
Pfeffer-/Salzmühle
Moulin à poivre/sel
Molinillo pimienta/sal

art.-P	art.-S	h. cm.
42707P21	42707S21	21
Noce. - Walnut.		
42709P21	42709S21	21
Ciliegio. - Wild cherry.		



N

COTTAGE - Macina pepe/sale
Pepper/salt mill
Pfeffer-/Salzmühle
Moulin à poivre/sel
Molinillo pimienta/sal

art.-P	art.-S	h. cm.
42672P22		22
Faggio - laccato grigio. Beech wood - gray lacquered.		
art.-P	art.-S	h. cm.
	42672S22	22
Faggio - laccato avorio. Beech wood - ivory lacquered.		



TAHITI - Macina pepe/sale
Pepper/salt mill
Pfeffer-/Salzmühle
Moulin à poivre/sel
Molinillo pimienta/sal

art.-P	art.-S	h. cm.
42792P15	42792S15	15
Faggio - nero opaco. Beech wood - black matt.		



U Select

CHATEAUNEUF - Macina pepe/sale
Pepper/salt mill
Pfeffer-/Salzmühle
Moulin à poivre/sel
Molinillo pimienta/sal

art.-P	art.-S	h. cm.
42781-23	42783-23	23
42781-30	42783-30	30
Inox-faggio - nero opaco. Stainless steel-beech wood - black matt.		



U Select

CHATEAUNEUF - Macina pepe/sale
Pepper/salt mill
Pfeffer-/Salzmühle
Moulin à poivre/sel
Molinillo pimienta/sal

art.-P	art.-S	h. cm.
42782-23	42784-23	23
42782-30	42784-30	30
Inox - faggio - ciliegio. Stainless steel - beech wood - cherry.		



U Select

MADRAS - Macina pepe/sale
Pepper/salt mill
Pfeffer-/Salzmühle
Moulin à poivre/sel
Molinillo pimienta/sal

art.-P	art.-S	h. cm.
42705P16	42705S16	16
42705P21	42705S21	21
Inox - faggio - cioccolato. Stainless steel - beech wood - chocolate.		



FIDJI - Macina pepe/sale
Pepper/salt mill
Pfeffer-/Salzmühle
Moulin à poivre/sel
Molinillo pimienta/sal

art.-P	art.-S	h. cm.
42767P12	42767S12	12
42767P15	42767S15	15
42767P20	42767S20	20

Inox - faggio - nero opaco.
Stainless steel - beech wood - black matt.



FIDJI - Macina pepe/sale
Pepper/salt mill
Pfeffer-/Salzmühle
Moulin à poivre/sel
Molinillo pimienta/sal

art.-P	art.-S	h. cm.
42766P12	42766S12	12
42766P15	42766S15	15
42766P20	42766S20	20

Inox - faggio - ciliegio.
Stainless steel - beech wood - cherry.



DAMAN - Macina pepe/sale
Pepper/salt mill
Pfeffer-/Salzmühle
Moulin à poivre/sel
Molinillo pimienta/sal

art.-P	art.-S	h. cm.
42764P16	42764S16	16
42764P21	42764S21	21

Inox - acrilico.
Stainless steel - acrylic.



BRASSERIE - Duo, macina pepe/sale
Duo, pepper/salt mill
Duo, Pfeffer-/Salzmühle
Duo, moulin à poivre/sel
Duo, molinillo pimienta/sal

art.	h. cm.
42710-11	11

ABS cromato - acrilico.
ABS chromed - acrylic.



COMMERCY - Macina pepe/sale
Pepper/salt mill
Pfeffer-/Salzmühle
Moulin à poivre/sel
Molinillo pimienta/sal

art.-P	art.-S	h. cm.
42780P15	42780S15	15

Inox - acrilico.
Stainless steel - acrylic.



METZ - Macina pepe/sale
Pepper/salt mill
Pfeffer-/Salzmühle
Moulin à poivre/sel
Molinillo pimienta/sal

art.-P	art.-S	h. cm.
42799P10	42799S10	10

Acrilico. - Acrylic.

BALI

COLOURS

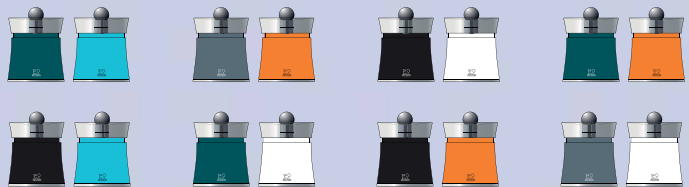

BALI - Macina pepe
Pepper mill
Pfeffer-Mühle
Moulin à poivre
Molinillo pimienta

art.	h. cm.	Col.
42661-01	8	●
42661-02	8	●
42661-03	8	●

Acrilico/ABS. - Acrylic/ABS

BALI - Macina sale
Salt mill
SalzMühle
Moulin à sel
Molinillo sal

art.	h. cm.	Col.
42661-04	8	●
42661-05	8	●
42661-06	8	○

Acrilico/ABS. - Acrylic/ABS



CHAUMONT - Macina pepe/sale
Pepper/salt mill
Pfeffer-/Salzmühle
Moulin à poivre/sel
Molinillo pimienta/sal

art.-P	art.-S	h. cm.
42798P11	42798S11	11
42798P16	42798S16	16

Acrilico. - Acrylic.



KARA - Macina pepe/sale
Pepper/salt mill
Pfeffer-/Salzmühle
Moulin à poivre/sel
Molinillo pimienta/sal

art.-P	art.-S	h. cm.
42671P15	42671S15	15

Acrilico/ABS. - Acrylic/ABS



NANCY - Macina pepe/sale
Pepper/salt mill
Pfeffer-/Salzmühle
Moulin à poivre/sel
Molinillo pimienta/sal

art.-P	art.-S	h. cm.
42727-09	42728-09	9
42727-12	42728-12	12
42727-18	42728-18	18
42727-22	42728-22	22
42727-30	42728-30	30
42727-38	42728-38	38

Acrilico. - Acrylic.



VITTEL - Macina pepe/sale
Pepper/salt mill
Pfeffer-/Salzmühle
Moulin à poivre/sel
Molinillo pimienta/sal

art.-P	art.-S	h. cm.
42796P16	42796S16	16
42796P23	42796S23	23
42796P30	42796S30	30

Acrilico. - Acrylic.



OUESSANT - Macina pepe/sale
Pepper/salt mill
Pfeffer-/Salzmühle
Moulin à poivre/sel
Molinillo pimienta/sal

art.-P	art.-S	h. cm.
42669P14	42669S14	14

Acrilico - inox.
Acrylic - stainless steel.



OUESSANT - Macina erbe/peperoncino
Herbs/chili mill
Kräuter-/Paprikamühle
Moulin à herbes/piment
Molinillo hierbas/chile

art.	h. cm.
42669C14	14

Acrilico - inox.
Acrylic - stainless steel.



Macina per sale umido
Wet sea salt mill
Mühle für Feuchtes Meersalz
Moulin à sel humide
Molinillo sal húmeda



art.	h. cm.	
42670N14	14	naturale/natural
42670B14	14	cioccolato/cocholate
42670W14	14	bianco/white

Acrilico - faggio. - Acrylic - beech wood.



OLERON - Macina pepe/sale
Pepper/salt mill
Pfeffer-/Salzmühle
Moulin à poivre/sel
Molinillo pimienta/sal

art.-P	art.-S	h. cm.
42662P14	42662S14	14

Acrilico - faggio - naturale.
Acrylic - beech wood - natural.



OLERON - Macina erbe/peperoncino
Herbs/chili mill
Kräuter-/Paprikamühle
Moulin à herbes/piment
Molinillo hierbas/chile

art.	h. cm.
42662C14	14

Acrilico - faggio - naturale.
Acrylic - beech wood - natural.

**TAVOLA TABLE TOP
PEUGEOT MACINE MILLS**



OLERON - Macina pepe/sale
Pepper/salt mill
Pfeffer-/Salzmühle
Moulin à poivre/sel
Molinillo pimienta/sal

art.-P	art.-S	h. cm.
42663P14	42663S14	14

Acrilico - faggio - cioccolato.
Acrylic - beech wood - chocolate.

OLERON - Macina erbe/peperoncino
Herbs/chili mill
Kräuter-/Paprikamühle
Moulin à herbes/piment
Molinillo hierbas/chile

art.	h. cm.
42663C14	14

Acrilico - faggio - cioccolato.
Acrylic - beech wood - chocolate.



AMBOINE - Macina noce moscata
Nutmeg mill
Muskatmühle
Moulin à mouscade
Molinillo nuez moscada

art.	h. cm.
42720-03	11

Acrilico - faggio - naturale.
Acrylic - beech wood - natural.



AMBOINE - Macina noce moscata
Nutmeg mill
Muskatmühle
Moulin à mouscade
Molinillo nuez moscada

art.	h. cm.
42720-02	11

Acrilico - faggio - cioccolato.
Acrylic - beech wood - chocolate.



TERNATE - Macina noce moscata
Nutmeg mill
Muskatmühle
Moulin à mouscade
Molinillo nuez moscada

art.	h. cm.
42720-00	11

Acrilico/ABS cromato.
Acrylic/ABS chromed.



TIDORE - Macina noce moscata
Nutmeg mill
Muskatmühle
Moulin à mouscade
Molinillo nuez moscada

art.	h. cm.
42720-01	11

Acrilico. - Acrylic.



PALACE - Macina pepe/sale
Pepper/salt mill
Pfeffer-/Salzmühle
Moulin à poivre/sel
Molinillo pimienta/sal

art.-P	art.-S	h. cm.
42725P10	42725S10	10

Metallo argentato - legno.
Silverplated - wood.



MIGNONNETTE - Macina pepe/sale
Pepper/salt mill
Pfeffer-/Salzmühle
Moulin à poivre/sel
Molinillo pimienta/sal

art.-P	art.-S	h. cm.
42723P10	42723S10	10

Metallo argentato. - Silverplated.

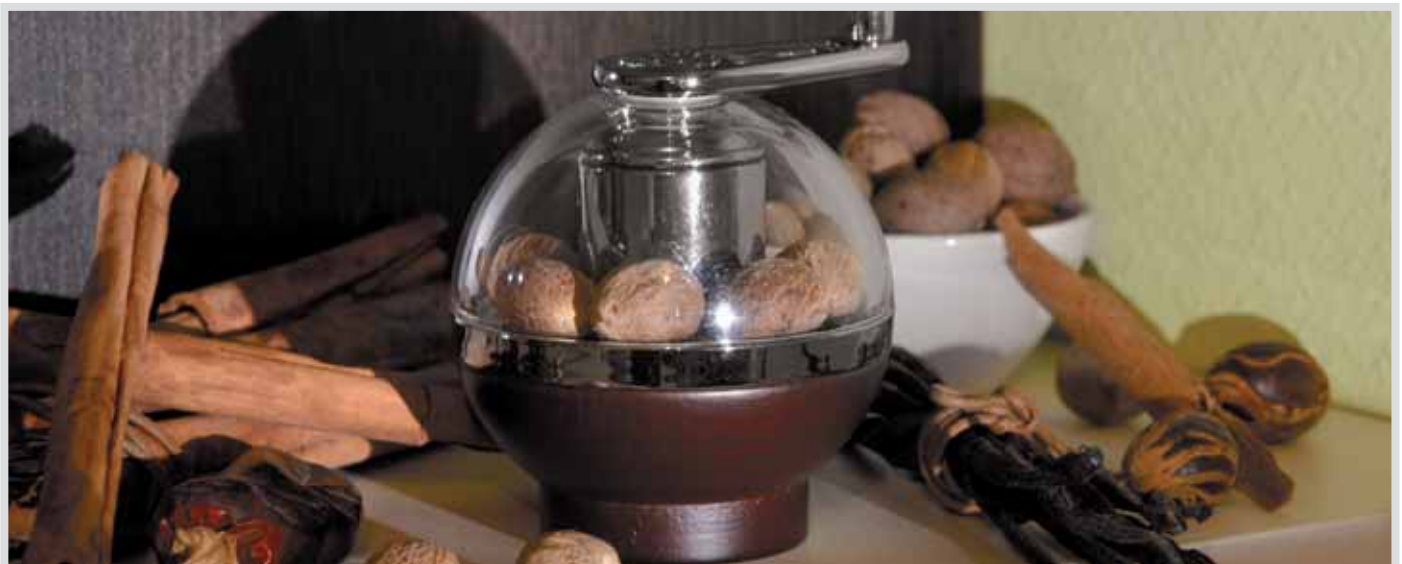



**UTENSILI GELATERIA, BAR, BUFFET E PRESENTAZIONE
ICE-CREAM UTENSILS, BAR, BUFFET AND PRESENTATION
ZUBEHÖR FÜR EISCREME, BAR, BUFFET UND PRÄSENTATION
UTENSILES POUR GLACE, BAR, BUFFET ET PRÉSENTATION
HELADERÍA, BAR, BUFFET Y PRESENTACIÓN**

GELATERIA - ICE CREAM





Coppa gelato, MS
Ice cream cup, MS
Eisbecher, MS
Coupe à glace, MS
Copa helado, MS

art.	h. cm.	lt.	u. pack
44942-10	16	0,25	6



Coppa gelato, MS
Ice cream cup, MS
Eisbecher, MS
Coupe à glace, MS
Copa helado, MS

art.	h. cm.	lt.	u. pack
44942-11	11	0,38	6



Coppa gelato, MS
Ice cream cup, MS
Eisbecher, MS
Coupe à glace, MS
Copa helado, MS

art.	h. cm.	lt.	u. pack
44942-12	6,5	0,26	6



Coppa macedonia, MS
Fruit cup, MS
Fruchtschale, MS
Coupe à dessert, MS
Copa frutas, MS

art.	Ø cm.	h.	u. pack
44942-07	10	10	6



Coppa gelato, MS
Ice cream cup, MS
Eisbecher, MS
Coupe à glace, MS
Copa helado, MS

art.	Ø cm.	h.	u. pack
44942-06	9	19	6



Vassoio Gourmet, melamina
Tray Gourmet, melamine
Tablett GOURMET, Melamin
Plateau, melamine
Bandeja, melamine

art.	dim. cm.	h.	Ø holes
44466-30	30,5x9,5	2,5	4



Ciotoline Gourmet, melamina
Bowl gourmet, melamine
Schälchen GOURMET, Melamin
Bol, melamine
Bols, melamine

art.	Ø cm.	h.	ml.
44466-07	7	6	50



Porta coni, inox
Ice cream cone holder, stainless steel
Eiswaffelständer, Edelstahl Rostfrei
Porte cornets à glace, inox
Soporte para cucuruuchos, inox

art.	dim. cm.	h.	Ø mm.
41472-01	20x9,5	8,5	26



Porta coni, inox
Ice cream cone holder, stainless steel
Eiswaffelständer, Edelstahl Rostfrei
Porte cornets à glace, inox
Soporte para cucuruuchos, inox

art.	dim. cm.	h.
41472-04	16,5	14



Porta coni, plexiglas
Ice cream cone holder, plexiglas
Eiswaffelständer, Plexiglas
Porte cornets à glace, plexiglas
Soporte para cucuruuchos, plexiglas

art.	Ø cm.	h.
41472-05	19	24

BAR HAPPY HOUR BUFFET



Contenitore per cialde, plexiglas
Waffle case, plexiglas
Waffelbehälter, Plexiglas
Porte gaufres, plexiglas
Contenedor para waffles, plexiglas

art.	dim. cm.	h.
41472-21	22x26	12



-27

-28

Decorazione gelato
Ice cream decoration
Eiskremedekoration
Décor à glace
Decoración para helado

art.	u. pack
48300-27	144
48300-28	144



Porta coni girevole, plexiglas
Revolving cones dispenser, plexiglas
Eiswaffelspender, drehbar, Plexiglas
Porte-cornets pivotant, plexiglas
Distributor giratorio de cucurucho, plexiglas

7art.	ø cm.	h.	ø int.
41472-15	24	78	5,4



Porta coni, apertura frontale, plexiglas
Cone holder, front opening, plexiglas
Eiswaffelspender, Plexiglas
Porte cornets à glace, ouverture frontale
Porta cucurucho, plexiglas

art.	dim. cm.	h.	ø int.
41472-16	11x13	50	5,2



Porta coppette, plexiglas
Bowls holder, plexiglas
Schalenspender, Plexiglas
Porte pots à glace, plexiglas
Soporte para bols, plexiglas

art.	dim. cm.	h.	int.
41472-11	11x11	35	9x9



Porta coppette girevole, plexiglas
Revolving bowls holder, plexiglas
Schalenspender, Plexiglas
Porte pot à glace, pivotant
Soporte para bols, giratorio, plexiglas

art.	ø cm.	h.	int.
41472-10	25	35	9x9



Porta palette, plexiglas
Spoon case, plexiglas
Eislöffelbehälter, Plexiglas
Porte cuillères à glace, plexiglas
Contenedor cucharitas, plexiglas

art.	dim. cm.	h.
41472-20	19x12,5	14



Porta cannucce, plexiglas
Straws holder, plexiglas
Strohalmbehälter, plexiglas
Porte chalumeaux, plexiglas
Porta canutillos, plexiglas

art.	dim. cm.	h.
41472-22	26x17	22



Bicchierino, monouso
Small glass, disposable
Klein Glass
Petite verre
Bol pequeño

art.	Ø cm.	h.	ml.	u.pack
48350-01	4,2	6,5	50	100
48350-02	5,0	6,5	80	100
48350-03	5,5	7,0	100	100
48350-04	6,0	9,0	160	100

Bicchierino, monouso
Small glass, disposable
Klein Glass
Petite verre
Bol pequeño

art.	cm.	h.	ml.	u.pack
48351-01	4x4	5,5	50	100
48351-02	5x5	7,0	100	100
48351-03	5,5x5,5	8,0	150	100

Bicchierino, monouso
Small glass, disposable
Klein Glass
Petite verre
Bol pequeño

art.	Ø cm.	h.	ml.	u.pack
48352-01	6,5	5,5	70	100
48352-02	7,0	6,7	120	100
48352-03	7,5	7,3	150	100



Bicchierino, monouso
Small glass, disposable
Klein Glass
Petite verre
Bol pequeño

art.	Ø cm.	h.	ml.	u.pack
48353-01	8,5	6,5	120	100

Bicchierino, monouso
Small glass, disposable
Klein Glass
Petite verre
Bol pequeño

art.	Ø cm.	h.	ml.	u.pack
48354-01	4	8,5	70	100



Coppetta, monouso
Cup, disposable
Schale, einweg
Bol, jetable
Bol, desechable

art.	Ø cm.	h.	ml.	u.pack
48365-09	9	7,5	175	100

Coppetta, monouso
Cup, disposable
Schale, einweg
Bol, jetable
Bol, desechable

art.	Ø cm.	h.	ml.	u.pack
48366-09	9	7,5	125	100

BAR HAPPY HOUR BUFFET



Bacinella per gelato, inox
Ice cream container, stainless steel
Eisbehälter, Edelstahl Rostfrei
Récipient à glace, inox
Cubeta helado, inox

art.	dim. cm.	h.	lt.
41471-12	36x16,5	12	5,0
41471-15	36x16,5	15	6,5
41471-17	36x16,5	17	7,5



Coperchio per bacinella gelato, plexiglas
Lid for ice cream container, plexiglas
Deckel für Eisbehälter, Plexiglas
Couverture pour récipient à glace, plexiglas
Tapa para cubeta helado, plexiglas

art.	dim. cm.
41471-00	36x16,5



Bacinella per gelato, inox
Ice cream container, stainless steel
Eisbehälter, Edelstahl Rostfrei
Récipient à glace, inox
Cubeta helado, inox

art.	dim. cm.	h.	lt.
41486-08	36x25	8	5
41486-12	36x25	12	8
41486-15	36x25	15	10



Bacinella per gelato, inox
Ice cream container, stainless steel
Eisbehälter, Edelstahl Rostfrei
Récipient à glace, inox
Cubeta helados, inox

art.	dim. cm.	h.	lt.
41487-12	26x16	12	3,5
41487-15	26x16	15	4,1
41487-17	26x16	17	4,5



Spatola gelato, inox
Ice cream server, stainless steel
Eispachtel, Edelstahl Rostfrei
Palette à glace, inox
Paleta helados, inox

art.	l. cm.
41475-00 ○	25
41475-01 ●	25
41475-03 ●	25
41475-04 ●	25
41475-05 ●	25



Spatola gelato
Ice-dipper
Eisdipper
Cuillère à glace
Cuchara helados

art.	Ø mm.	lt.
41468-20	55	1/20 aluminum
41468-24	50	1/24 aluminum

Con liquido conduttore nel manico.
With liquid heat conductor in the handle.



Spatola gelato
Ice-dipper
Eisdipper
Cuillère à glace
Cuchara helados

art.	Ø mm.	lt.
41469-20	55	1/20 teflon
41469-24	50	1/24 teflon

Con liquido conduttore nel manico.
With liquid heat conductor in the handle.



Porzionatore, inox
Ice cream scoop, stainless steel
Eisportionierer, Edelstahl Rostfrei
Cuillère à glace, inox
Racionador de helado, inox

art.	Ø mm.	lt.
41476-50	50	1/24

Manico antiscivolo. - Non slip handle.



Porzionatore, inox
Ice cream scoop, stainless steel
Eisportionierer, Edelstahl Rostfrei
Cuillère à glace, inox
Racionador de helado, inox

art.	Ø mm.	lt.
41473-31	30	1/100
41473-39	38	1/65
41473-44	43	1/50
41473-50	50	1/24
41473-56	55	1/20
41473-62	60	1/14
41473-66	66	1/12



Porzionatore ovale, inox
Oval ice cream scoop, stainless steel
Eisportionierer, oval, Edelstahl Rostfrei
Cuillère à glace ovale, inox
Racionador de helado, inox

art.	Ø mm.	lt.
41474-00	60	1/30



Porzionatore rettangolare, inox
Rectangular ice cream scoop, s/s
Eisportionierer, rechteckig, Edelstahl
Cuillère à glace, rectangulaire, inox
Racionador de helado, inox

art.	lt.
41474-01	1/30



Porzionatore triangolare, inox
Triangle ice cream scoop, s/s
Eisportionierer, dreieckig, Edelstahl
Cuillère à glace, triangle, inox
Racionador de helado, inox

art.	lt.
41474-02	1/30



Stampo gelato
Ice cream mold
Eis-Ausstechforme
Moule à glace
Molde para helado

Stampo gelato
Ice cream mold
Eis-Ausstechforme
Moule à glace
Molde para helado

Stampo gelato
Ice cream mold
Eis-Ausstechforme
Moule à glace
Molde para helado

art.	int. dim. mm	ml.	pz/pcs	art.	int. dim. mm	ml.	pz/pcs	art.	int. dim. mm	ml.	pz/pcs
41466-01	93x48,5x25	90	12	41466-02	93x48,5x25	90	12	41466-03	93x48,5x25	90	8

Set 2 stampi + vassoio 295x395 mm + 50 stecchi legno. - Set 2 molds + tray 295x395 mm + 50 wooden sticks.



KAYSER



Sifone panna, inox
Professional cream whipper, stainless steel
Profi-Sahnebereiter, 18-10 Edelstahl
Siphon à crème professionnel, inox
Sifón montador de nata profesional, inox

Ricariche panna montata, conf. 10 pezzi
Cream chargers, 10-pcs set
10-Stk. Sahnekapseln-Packung
Capsules à crème Chantilly, set 10 pièces
Cápsulas para nata, 10 piezas

art.	lt.
41451-05	0,5
41451-10	1,0

art.
41450-AA

Due ugelli inclusi. Testa e bottiglia anticorrosione in acciaio inox. Lavabile in lavastoviglie per una buona e reale igiene. - Two nozzles included. Head and bottle made in rust-free stainless steel. Can be placed in the dishwasher for effective and hygienic washing.

Contenuto sotto pressione, non idoneo a spedizione via aerea. Contiene N2O. - Contains N2O under pressure, not suitable for air-shipment.



Sifone panna, GOURMET WHIP
 Cream whipper
 Sahnebereiter
 Siphon à crème
 Sifón para preparación de nata montada



art.	lt.
41458-02	0,25
41458-05	0,50
41458-10	1,00

Bottiglia e testata in acciaio inossidabile. Testata con impugnatura protettiva in silicone e valvola fissa in acciaio inox. Guarnizione in silicone resistente al calore. Tenere a bagnomaria max. a 75°C. Dotato di 3 bocchette inox, lancia, tulipano, stella e scovolino. Lavabile in lavastoviglie. *Stainless steel bottle and head. Head with protective silicone grip and fixed stainless steel valve. Heat resistant silicone gasket. Keep warm in bain marie up to 75°C. Inclusive stainless steel straight tip, tulip tip, star tip, cleaning brush. Dishwasher-safe.*



Sifone termico, THERMO WHIP
 Thermo whipper
 Thermo-Sahnebereiter
 Siphon à crème, isotherme
 Sifón isotérmico



art.	lt.
41455T55	0,50

Bottiglia e testata in acciaio inossidabile. Testata con impugnatura protettiva in silicone e valvola fissa in acciaio inox. Bottiglia termica a doppia parete. Mantiene le preparazioni in caldo fino a 3 ore e a freddo fino a 8 ore. Dotato di 3 bocchette inox, lancia, tulipano, stella e scovolino. Lavabile in lavastoviglie. - *Stainless steel bottle and head. Head with protective silicone grip and fixed stainless steel valve. Double-walled, vacuum-insulated bottle: keeps creations cold for 8 hours and hot for 3 hours. Inclusive stainless steel straight tip, tulip tip, star tip, cleaning brush. Dishwasher-safe.*



Sifone termico, THERMO XPRESS WHIP
 Thermo whipper
 Thermo-Sahnebereiter
 Siphon à crème, isotherme
 Sifón isotérmico



art.	lt.	h. cm.
41459-10	1,00	35

Apparecchio da banco dotato di sistema pescante, pulsante di erogazione a pressione e bottiglia termica in acciaio inox a doppia parete. Mantiene le preparazioni in caldo fino a 3 ore e a freddo fino a 8 ore. Vassoio raccogli gocce, antiscivolo in silicone con griglia inox. Bottiglia lavabile in lavastoviglie. - *Freestanding device with riser tube system and push button operation. Double-walled, stainless steel vacuum insulated bottle: keeps creations cold for 8 hours and hot for 3 hours. Non-slip silicone drip tray with stainless steel plate, for clean workstations. Bottle: Dishwasher-safe.*



Sifone panna, CREAM PROFI WHIP
 Cream whipper
 Sahnebereiter
 Siphon à crème
 Sifón para preparación de nata montada



art.	lt.
41460-05	0,50
41460-10	1,00

Solo per preparazioni fredde. Bottiglia e testata in acciaio inox. Calotta con impugnatura protettiva in silicone e valvola inox estraibile. Riporre in frigorifero da 4-6 ore in posizione verticale con la calotta rivolta verso il basso. Agitare in verticale 3-4 volte prima di servire. Dotazione 1 beccuccio a lancia e 1 beccuccio a tulipano e scovolino. Lavabile in lavastoviglie. - *Only for cold preparations. Stainless steel bottle and head. Head with protective silicone grip and removable stainless steel valve. Store in refrigerator for 4-6 hours upside down. Shake vertically 3-4 times before serving. Inclusive s/s straight tip, tulip tip, cleaning brush. Dishwasher-safe.*



Ricariche panna montata, conf. 10 pezzi
 Cream chargers, 10-pcs set
 10-Stk. Sahnekapseln-Packung
 Capsules à crème Chantilly, set 10 pièces
 Cápsulas para nata, 10 piezas

art.
41455-AA

Riempite con 8 g di puro N2O (E942 protossido di azoto). 1 carica per 0,50 lt., 2 cariche per 1 lt. 100% acciaio riciclabile. - *Filled with 8 g of pure N2O (E942, nitrous oxide). A charge for 0,50 lt., two charges for 1 lt. 100% recyclable stainless steel.*



Bocchette, set 3 pezzi
 Decorating tips, 3-pcs set
 Dekorationstüllen, 3er Set
 Douilles de décoration, 3 pièces
 Boquillas de decoración, 3 piezas

art.
41455-BC

1 bocchetta tulipano, 1 stella, 1 lancia. - *1 Tulip Tip, 1 Star Tip, 1 Straight Tip.*

isi

Imbuto e colino, inox
 Funnel & sieve, stainless steel
 Trichter & Sieb, Edelstahl Rostfrei
 Entonnoir, inox
 Embudo & tamiz, inox

art.
 41458-11



BAR HAPPY HOUR BUFFET CAPPUCCINO



Bocchette decoro e adattatore
 Decorating tips and adapter
 Dekorationstüllen-Set u. Adapter
 Douilles de décoration et adaptateur
 Boquillas de decoración y adaptador

art.
 41458-24
 1 bocchetta petalo, 1 quadrata, 1 rosa, 1 adattatore. - 1 petal piping tip, 1 square tip, 1 rose tip, 1 adapter.



Bocchette inox
 Decorating tips, stainless steel
 Dekorationstüllen-Set, Edelstahl Rostfrei
 Douilles de décoration, inox
 Boquillas de decoración, inox

art.
 41458-23
 1 bocchetta tulipano, 1 stella, 1 liscia.
 1 tulip tip, 1 tar tip, 1 straight tip.



Iniettori/siringhe decoro, inox
 Injector needles, stainless steel
 Nadeltüllen, Edelstahl Rostfrei
 Aiguilles d'injection, inox
 Boquillas de aguja, inox

art.
 41458-21
 2 iniettori lunghi e 2 corti Ø 3-5 mm, 4 cappucci protettivi. Per decorare, iniettare liquidi, marinare, irrorare, e bagni di calcio. - 2 long & 2 short Injector tips Ø 3-5 mm, 4 protective covers. Ideal for decoration, stuffing food, liquid injections, marinating, injecting and basting, frying and fat cooking, water and calcium bath.



La sferificazione è un processo culinario che consiste nel modellare un liquido in sfere che visivamente e strutturalmente sembrano caviale e possono essere usate in cibi o bevande. Spherification is the culinary process of shaping a liquid into spheres which visually and texturally resemble caviar for use in food or beverages.



Protezione in silicone
 Heat protector, silicone
 Silikonhülle
 Housse en silicone
 Protección de silicona

art. lt.
 41458-50 0,50
 41458-51 1,00

N

Kit di infusione rapida
 Kit rapid infusion
 Rapid Infusion Set
 Paquet rapid infusion
 Rapid infusion set

art.
 41458-25
 Incl.: guarnizione per setaccio in silicone, setaccio inox, tubo di ventilazione inox, tubo di silicone, scovolino. - Contains: sieve gasket 100% silicone, stainless steel internal sieve, s/s ventilation tube, silicone tube, cleaning brush.

N

Il kit di infusione rapida permette di infondere un liquido con sapori diversi in tempo rapido. Unire gli aromi solidi (erbe, spezie, frutta, ecc.) con il liquido (alcool, olio, acqua, aceto, ecc.) nel sifone ed immettere una carica per panna (art. 41455-AA). Il sapore degli aromi solidi viene infuso nel liquido, che sviluppa così un gusto unico. - Rapid Infusion enables a liquid to be infused with different flavors in the shortest possible time. First, combine aromatic solids (e.g. herbs, spices, fruit) and a liquid (e.g. alcohol, oil, water, vinegar) in the Whipper. By applying pressure into the Whipper using a cream charger (#41455-AA), the flavor of the solids becomes infused into the Liquid, which develops a unique taste.

BAR HAPPY HOUR BUFFET



Sifone soda
Soda siphon
Soda Siphon
Siphon à eau de seltz
Sifón agua de seltz

art.	lt.
41453-07	0,75
41453-11	1,00



Per la preparazione di acqua gassata, bibite e cocktail effervescenti. Bottiglia in acciaio inox di alta qualità. Valvola di regolazione della pressione per il massimo comfort e sicurezza. Impugnatura antiscivolo in silicone.
For the preparation of pure soda water, sparkling refreshments & cocktails. High-quality stainless steel bottle. Pressure control valve for maximum comfort and safety. Ergonomic charger holder with non-slip silicone grip.



Ricariche soda, conf. 10 pezzi
Soda chargers, 10-pcs set
10-Stk. Sodakapseln-Packung
Capsules à eau de seltz, set 10 pcs
Cápsulas para agua de seltz, 10 pz

art.
41453-AA

Ogni capsula contiene 8 gr di pura CO2.
Each Cream Charger contains 8 g of pure CO2.



Kit 10 mascherine, plastica
Set of 10 stencils, plastic
Satz 10 Masken, kunststoff
Set 10 pcs masques, plastique
Juego 10 máscaras, plástico

art.	ø cm.
47859-01	10



Kit 10 mascherine, plastica
Set of 10 stencils, plastic
Satz 10 Masken, kunststoff
Set 10 pcs masques, plastique
Juego 10 máscaras, plástico

art.	ø cm.
47859-02	10



Kit 4 mascherine, plastica
Set of 4 stencils, plastic
Satz 4 Masken, kunststoff
Set 4 pcs masques, plastique
Juego 4 máscaras, plástico

art.	ø cm.
47859-03	10



Kit spargicacao & 7 mascherine, inox
Cocoa duster with 7 discs, stainless steel
Kakaostreuer mit 7 Masken, Edelstahl
Glacière à cacao & 7 masques, inox
Dosificador cacao con 7 máscaras, inox

art.	ø cm.	h.
42923-07	6,5	13



Spargicacao, inox
Cocoa dredger, stainless steel
Kakaostreuer, Edelstahl Rostfrei
Saupoudreuses, inox
Espiciero, inox

art.	ø cm.	h.	ml.
41607-00	5,5	7,5	160

Fori/Holes: Ø 1,5 mm.



Spargizucchero, inox
Shaker, stainless steel
Zuckerstreuer, Edelstahl Rostfrei
Saupoudreuses, inox
Espiciero, inox

art.	ø cm.	h.	ml.	mm.
47023-01	7	9	300	1,5
47023-02	7	9	300	2,5
47023-03	7	9	300	5,0
47023-04	7	9	300	mesh



Spargizucchero
Sugar pourer
Zuckerstreuer
Sucrier
Dispensador azúcar

art.	ø cm.	h.	ml.
41525-01	8,4	15,5	150



Spargizucchero, vetro e inox
Sugar pourer, glass and stainless steel
Zuckerstreuer, Glas u. Edelstahl Rostfrei
Sucrier, verre et inox
Azucarero, vidrio y inox

art.	ml.
42920-02	360



Spargizucchero, dosatore
Sugar pourer
Zuckerstreuer
Sucrier doseur
Azucarero dosificador

art.	ml.
41645-00	360



Dosatore miele, cremiera
Honey/cream dispenser
Sahnekännchen
Doseur pour miel/lait
Dosificador para miel/leche

art.	ø cm.	h.	ml.
41525-00	8,5	13,5	150



Lattiera/teiera
Milk pot/tea pot
Milchgießer/Teekanne
Pot à lait/théière
Jarra leche/tetera

art.	lt.
66303-01	0,15
66303-03	0,30
66303-06	0,60



Lattiera cappuccino
Cappuccino milk pot
Capuccino-Milchkanne
Pot à cappuccino
Jarra cappuccino

art.	lt.
66307-06	0,60
66307-09	0,90
66307-12	1,20



Portabustine zucchero, inox
Sugar bags holder, stainless steel
Zuckertütenschale, Edelstahl Rostfrei
Conteneur à sucre, inox
Contenedor sobres azúcar, inox

art.	dim. cm.	h.
66374-00	13x6	4



Portabustine zucchero
Sugar bags holder
Zuckertütenschale
Conteneur à sucre
Contenedor sobres azúcar

art.	dim. cm.	h.	col.
44104-01	8,5x6,5	5	nero/black
44104-02	8,5x6,5	5	trasp./clear



Portatovaglioli, inox
Napkin dispenser, stainless steel
Serviettenspender, Edelstahl Rostfrei
Conteneur pour serviettes, inox
Servilletero, inox

art.	dim. cm.	h.
41601-17	8,5x11	12,5

P



Portatovaglioli in filo cromato
Napkin holder, chrome plated wire
Serviettenhalter, Metall verchromt
Porte-serviettes en fil chromé
Servilletero en hilo cromado

art.	dim. cm.	h.
41617-05	19x19	6,5
41617-15	19x19	19,0



Portatovaglioli in filo cromato
Napkin holder, chrome plated wire
Serviettenhalter, Metall verchromt
Porte-serviettes en fil chromé
Servilletero en hilo cromado

art.	dim. cm.	h.
41618-14	14x14	6,5

N



Portatovaglioli, inox
Napkin holder, stainless steel
Serviettenhalter, Edelstahl Rostfrei
Porte serviettes, inox
Servilletero, inox

art.	dim. cm.	h.
66391-00	10x3	8



Vassoio quadrato, inox
Tray, square, stainless steel
Serviettablett, quadratisch, Edelstahl
Plateau carré, inox
Bandeja cuadra, inox

art.	dim. cm.	h.
41625-23	23x23	1,5



Vassoio conto, inox 18 Cr
Cash tray, 18 Cr stainless steel
Rechnungstablett, Edelstahl 18 Cr
Plateau porte-monnaie, inox 18 Cr
Bandeja cuentas, acero 18 Cr

art.	dim. cm.
66318-19	19x14
66318-22	22x15



Alzata dolci, 2 piani, cromata
Pastry stand, 2 tiers, chrome plated
Gebäckständer, 2-stöckig, verchromt
Serveur muet, 2 étages, chromé
Soporte dulces, 2 niveles, cromado

art.	ø cm.	h.
42975-02	11-14	16



Cestino agrumi, inox
Fruit basket, stainless steel
Obstkorb, Edelstahl Rostfrei
Panier à fruits, inox
Cesta frutas, inox

art.	Ø cm.	h.
41611-20	21,5	20



Espositore porta frutta
Fruit stand
Obstspender
Étagère à fruits
Expositor frutas

art.	Ø cm.	h.
41449-27	27,5	32



Espositore porta frutta
Fruit stand
Obstspender
Étagère à fruits
Expositor frutas

art.	Ø cm.	h.
41449-32	32	53

Supporto in filo cromato, ciotola estraibile in acciaio inox.
Chrome plated wire stand with removable stainless steel bowl.



Spremiagrumi manuale, prof., cromato
Professional orange juicer, chromed
Profi-Orangenpresse, verchromt
Presse-agrumes, professionnel, chromé
Exprimidor de cítricos, prof., cromado

art.	dim. cm.	h.
41456-00	19x18	56



Spremiagrumi manuale, cromato
Orange juicer, chromed
Orangenpresse, verchromt
Presse-agrumes, chromé
Exprimidor de cítricos, cromado

art.	dim. cm.	h.
41456-02	18x13	46



P

Spremilimone, inox
Lemon squeezer, stainless steel
Zitronenpresse, Edelstahl Rostfrei
Presse citron, inox
Exprime limones, inox

art.	dim. cm.
41606-00	12,5x6,5



P

Spremilimone cromato
Lemon squeezer, chromed
Zitronenpresse, verchromt
Presse citron, chromé
Exprime limones, cromada

art.
41606-01



P

Spremilimone, alluminio
Lemon squeezer, aluminum
Zitronenpresse, aluminum
Presse citron, alu
Exprime limones, aluminio

art.	l. cm.
41606-02	20



Rompighiaccio
Ice pick
Eisstößel
Casse-glace
Pick hielo

art. 44105-00



Tritaghiaccio, cromato
Chromed ice crusher
Eiswolf, verchromt
Broyer à glace, chromé
Trituradora de hielo, cromada

art. 41457-00 dim. cm. 15x12 h. 26



Tritaghiaccio, cromato
Chromed ice crusher
Eiswolf, verchromt
Broyer à glace, chromé
Trituradora de hielo, cromada

art. 41457-00 dim. cm. 15x12 h. 26

P



Sessola per ghiaccio, inox
Ice scoop, stainless steel
Eisschaufel, Edelstahl Rostfrei
Pelle à glace, inox
Librador para hielo, inox

art. 41503-00 ml. 100



Sessola per ghiaccio, PC
Ice cubes scoop, PC
Eisschaufel, PC
Pelle à glaçons, PC
Librador para hielo, PC

art. 14958-01 ml. 100
14958-02 250



Cucchiaio ghiaccio, inox
Ice spoon, stainless steel
Eislöffel, Edelstahl Rostfrei
Cuillère à glace, inox
Cuchara hielo, inox

art. 52550-04 l. cm. 22

P



Stampo per sfere di ghiaccio, PP
Mold for ice-balls, PP
Eis-Kugel-Former, PP
Moule pour boules de glace, PP
Molde de cubitos de hielo esféricos, PP

art. 41515-03 dim. cm. 23,5x8,5 h. 6,5

Per 3 sfere ø 5,5 cm da 100 ml.
For 3 balls ø 5,5 cm, 100 ml.



P

Secchio ghiaccio con molla
Ice bucket with tong
Eiseimer mit Eiszange
Seau à glace avec pince
Cubo hielo con pinza

art. 41513-13 Ø cm. 14 h. 22 lt. 1,3

Camicia in materiale plastico, finitura cromata lucida con speciale inserto termico. *Noble plastic jacket highly chrome plated with special insulated plastic insert.*



Secchio ghiaccio, plastica
Ice bucket, plastic
Eiseimer, Kunststoff
Seau à glace, plastique
Cubo hielo, plástico

art. 41512-15 Ø cm. 15 h. 15 lt. 1,5
41512-30 20 18 3,0

Finitura effetto metallo satinato, bordo lucido. Speciale inserto termico. - *Satin metal look with highly polished edge. Special insulated plastic insert.*



Secchio ghiaccio, PP-SAN
Ice box
Eisbox
Seau à glaçons
Cubitera

art. 41512-50 dim. cm. 27x27 h. 15 lt. 5,4

Con griglia. - *With drainer.*

N



Secchio ghiaccio, inox
Ice bucket, stainless steel
Eisbehälter, Edelstahl Rostfrei
Seau à glace, inox
Cubitera hielo, inox

art.	Ø cm.	h.
56116-15	12,5	13



Porta oggetti da bar
Bar organizer
Bar-Behälter
Porte-objets à bar
Dispensador bar

art.	dim. cm.	h.
44102-24	24x14,5	11



Porta cannucce, inox
Straw holder, stainless steel
Röhrchenbehälter, Edelstahl Rostfrei
Porte chalumeaux, inox
Porta canutillos, inox

art.	Ø cm.	h.
66313-06	8	12



Porta cucchiaini, inox
Spoon holder, stainless steel
Kaffeelöffelbehälter, Edelstahl Rostfrei
Porte cuillères, inox
Porta cucharas, inox

art.	Ø cm.	h.
66313-03	6	9



Set da bar, 5 pezzi, inox
Bar set, 5 pieces, stainless steel
Bar-Set, 5-tlg., Edelstahl Rostfrei
Set 5 pièces à cocktail, inox
Juego 5 piezas cóctel, inox

art.
41510-05



Colino cocktail, inox
Cocktail strainer, stainless steel
Cocktail-Sieb, Edelstahl Rostfrei
Passoire à cocktail, inox
Colador cóctel, inox

art.	Ø cm.	l.
41603-00	9	17



Cucchiaio miscelatore, inox
Cocktail spoon, stainless steel
Cocktail-Löffel, Edelstahl Rostfrei
Cuillère à cocktail, inox
Cuchara cóctel, inox

art.	l. cm.
41605-00	27



Pinza, inox
Cooking tong, stainless steel
Kochzange, Edelstahl Rostfrei
Pinze, inox
Pinza, inox

art.	l. cm.
42902-31	30



Pinza, inox
Cooking tong, stainless steel
Kochzange, Edelstahl Rostfrei
Pinze, inox
Pinza, inox

art.	l. cm.
42902-30	30



Cucchiaio bibita, inox
Ice tea spoon, stainless steel
Limonadenlöffel, Edelstahl Rostfrei
Cuillère à soda, inox
Cuchara refresco, inox

art.	l. cm.	u. pack
41605-25	25	6



Cucchiaio magico, inox
Magic spoon whisks, stainless steel
Zaubertöffel, Edelstahl Rostfrei
Cuillère magique, inox
Cuchara mágica, inox

art.	l. cm.
41595-20	20



Misurino cocktail, inox
Cocktail measuring cup, stainless steel
Alkohol-Meßbecher, Edelstahl Rostfrei
Mesureur de cocktail, inox
Medidor de cóctel, inox

art.	Ø cm.	h.
41604-00	3,5-4	7



Tagliere bar, PE
Cutting board, PE
Tranchierbrett, PE
Planche à découper, PE
Tabla de corte, PE

art.	dim. cm.	h.
42521-16	16x24,5	1
42521-24	24,5x32,5	1

Con piedini antiscivolo. - With non-slip feet.



Tagliere con vasca, PE
Cutting board with tray, PE
Tranchierbrett mit Tablett, PE
Planche à découper avec plateau, PE
Tabla de corte con bandeja, PE

art.	dim. cm.	h.
44947-00	33,5x46	5,5



Portacondimenti, acrilico
Condiment holder, acrylic
Bar-Beilagenbehälter, acryl
Boîte à condiments, acrylique
Caja condimentos, acrílico

art.	dim. cm.	h.
44947-03	37x14	12



Portacondimenti, inox
Condiment holder, stainless steel
Bar-Beilagenbehälter, Edelstahl Rostfrei
Boîte à condiments, inox
Caja condimentos, inox

art.	dim. cm.	h.
41782-04	32x16	10
41782-05	39x16	10
41782-06	47x16	10



Portacondimenti, ABS
Condiment holder
Bar-Beilagenbehälter
Boîte à condiments
Caja condimentos

art.	dim. cm.	h.	comp.
44103-03	49x15	9	3
44103-04	49x15	9	4
44103-06	49x15	9	6



Tappetino bar
Bar runner
Gläserabstellmatte
Tapis à verres
Tapete para vasos

art.	dim. cm.
44100-01	68x8
44100-02	45x30



Tappeto antiscivolo componibile
Bar mat, non-slip
Gläserabstellmatte, rutschfest
Tapis antidérapant, composable
Alfombra antiderrapante, componible

art.	dim. cm.
44100-04	30x30



Tappeto sottobicchieri, PE
Bar liner, PE
Gläsermatte, PE
Tapis à verres, PE
Tapete para vasos, PE

art.	h. cm.	mt.
44099-02	60	12,5



Tappeto sottobicchieri, PE
Bar liner, PE
Gläsermatte, PE
Tapis à verres, PE
Tapete para vasos, PE

art.	h. cm.	mt.
44099-03	60	13



Agitatore Boston, rivestimento vinile
Boston shaker, vinyl coated
Boston-Shaker, Vinyl Überzug
Shaker Boston, revêtement en vinyle
Coctelera Boston, revestimiento vinilo

art.	ø cm.	h.	ml.	col.
41479-11	9	18	830	●
41479-12	9	18	830	●
41479-13	9	18	830	●
41479-14	9	18	830	●
41479-15	9	18	830	○



Cono Boston con fondello, inox
Boston cone, stainless steel
Boston Shaker, Edelstahl Rostfrei
Boston cône, inox
Coctelera Boston, inox

art.	ø cm.	h.	ml.
41479-05	9,2	17,2	500



Bicchiera vetro
Mixing glass
Becherglas
Verre
Vaso vidrio

art.	ø cm.	h.	ml.
41477-50	9	15	473

Graduato in once. - With ounce markings.

BAR HAPPY HOUR BUFFET



P

Bicchiere vetro
Mixing glass
Becherglas
Verre
Vaso vidrio

Bicchiere vetro
Mixing glass
Becherglas
Verre
Vaso vidrio

Shaker, inox
Long-drink shaker, stainless steel
Shaker, Edelstahl Rostfrei
Shaker, inox
Coctelera, inox

art.	ø cm.	h.	ml.
41479-AA	8,5	15	500

art.	ø cm.	h.	ml.
41478-50	8,8	15	473
41478-35	8,3	13	355

art.	ml.
41480-03	200
41480-05	500
41480-07	700



P



P

Shaker, inox-SAN
Cocktail shaker, s/s-SAN
Shaker, Edelstahl-SAN
Shaker, inox-SAN
Coctelera, inox/SAN

Shaker, acrilico
Shaker, acrylic
Shaker, Kunststoff
Shaker, acrylique
Coctelera, acrílico

art.	ml.	col.
41481-02	550	●
41481-03	550	●

art.	ml.
41483-04	420
41483-06	660



N



Bottiglietta vetro
Dash bottle, glass
Dash Bottle aus Glas
Dash bottle, verre
Dash bottle, vidrio

Tappo dosatore
Dash bottle pourer
Ausgiesser
Bouchon verseur
Tapón vertedor

art.	ml.
41681-04	100

art.
41681-99

Senza dosatore. - Without pourer.





Bottiglietta vetro
Dash bottle, glass
Dash Bottle aus Glas
Dash bottle, verre
Dash bottle, vidrio

art. ml.
41681-01 100

Senza dosatore. - Without pourer.



Bottiglietta vetro
Dash bottle, glass
Dash Bottle aus Glas
Dash bottle, verre
Dash bottle, vidrio

art. ml.
41681-02 200

Senza dosatore. - Without pourer.



Bottiglietta vetro
Dash bottle, glass
Dash Bottle aus Glas
Dash bottle, verre
Dash bottle, vidrio

art. ml.
41681-03 330

Con dosatore. - With pourer.



Contenitore versatore
Pouring container
Dosier-Vorratsbehälter, komplett
Récipient verseur
Recipiente vertedor

art.		ø cm.	h.	lt.
44106W05	44106G05	9,0	26	0,5
44106W10	44106G10	9,0	33	1,0
44106W20	44106G20	12,5	35	2,0
44106W25	44106G25	12,5	39	2,5
W= BIANCO/WHITE G= VERDE/GREEN				
44106Y05	44106R05	9,0	26	0,5
44106Y10	44106R10	9,0	33	1,0
44106Y20	44106R20	12,5	35	2,0
44106Y25	44106R25	12,5	39	2,5
Y= GIALLO/YELLOW R= ROSSO/RED				
44106O05	44106B05	9,0	26	0,5
44106O10	44106B10	9,0	33	1,0
44106O20	44106B20	12,5	35	2,0
44106O25	44106B25	12,5	39	2,5
O= ARANCIONE/ORANGE B= MARRONE/BROWN				



Contenitore di riserva
Storage canister
Vorratsbehälter
Récipient réserve
Recipiente reserva

art.		ø cm.	h.	lt.
44107W05	44107G05	9,0	9,5	0,5
44107W10	44107G10	9,0	16,0	1,0
44107W20	44107G20	12,5	20,0	2,0
44107W25	44107G25	12,5	23,0	2,5
W= BIANCO/WHITE G= VERDE/GREEN				
44107Y05	44107R05	9,0	9,5	0,5
44107Y10	44107R10	9,0	16,0	1,0
44107Y20	44107R20	12,5	20,0	2,0
44107Y25	44107R25	12,5	23,0	2,5
Y= GIALLO/YELLOW R= ROSSO/RED				
44107O05	44107B05	9,0	9,5	0,5
44107O10	44107B10	9,0	16,0	1,0
44107O20	44107B20	12,5	20,0	2,0
44107O25	44107B25	12,5	23,0	2,5
O= ARANCIONE/ORANGE B= MARRONE/BROWN				



Tappo per versatore
Pouring container cap
Dosier-Behälterstopfen
Bouchon à récipient verseur
Tapón para recipiente vertedor

art. u. pack
44107-12 12 pz/pcs



P

Caraffa, MS
Juice pitcher, MS
Saftkanne, MS
Carafe à jus de fruits, MS
Jarra zumo, MS

art. ø cm. h. lt.
44992-02 16,5 26 2

Antiurto e antigraffio, non idoneo al lavaggio in lavastoviglie, resistente fino a +85°C. - Shockproof, scratchproof, no dishwasher safe, heat resistant up to +85°C.



P

Caraffa, MS
Juice pitcher, MS
Saftkanne, MS
Carafe à jus de fruits, MS
Jarra zumo, MS

art. ø cm. h. lt.
44992-03 26 29 3



Flair bottle
Flair bottle
Flair bottle
Flair bottle
Flair bottle

art. lt. col.
44108-01 0,75 ○
44108-02 0,75 ●

BAR HAPPY HOUR BUFFET



Principi di densità.

Per i cocktail analcolici il contenuto di zucchero dei vari liquidi determinerà la differenza di densità. Bagnare il galleggiante prima dell'uso. Versare a uno a uno i liquidi nel cocktail master, dal più dolce al meno denso, per ottenere un fantastico cocktail multicolore.

Density principles.

For alcohol-free drinks the density difference depends from the quantity of sugar of each liquid. Wet the float before use. Pour the liquids one after another in the cocktail master from the sweetest to the less dense, to get fantastic multicolored cocktails.

Cocktail Master

art.
41484-00



Bordatore bicchieri
Glass rimmer
Bar-Kombination Salz-/Zuckerumrander
Bordeur à verres
Ribeteador de vasos

art. Ø cm.
44101-03 15,5



Spazzole lavabicchieri, nylon
Glass cleaning brush, nylon
Bierglasbürstenständer, nylon
Brosse à laver les verres, nylon
Cepillo triple, nilón

art. h. cm.
44130-02 16,5
44130-03 21,5



Spazzola lavabicchieri, nylon-alluminio
Glass cleaning brush, nylon-aluminum
Bierglasbürstenständer, nylon-aluminium
Brosse à laver les verres, nylon-alu
Cepillo para lavar vasos, nilón-aluminio

art. Ø cm. h.
44130-01 15 19



Lavabicchieri, inox
Glass cleaning brush, stainless steel
Gläserpüler, Edelstahl Rostfrei
Brosse à laver les verres, inox
Cepillos para lavar vasos, inox

art. dim. cm. h.
44135-02 38x18 29



Rastrelliera, fissaggio sospeso
Glass shelf rack
Gläserhalter Regalmontage
Rack à verres fixation suspendue
Rack de copas

art. dim. cm. h.
44060-01 45x31,6 5,5

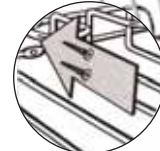

Rastrelliera, fissaggio murale
Glass wall rack
Gläserhalter Wandmontage
Rack à verres fixation murale
Rack de copas

art. dim. cm. h.
44060-02 45x31,6 5,5



Rastrelliera, inox
Speed rack, stainless steel
Flaschenregal, Edelstahl Rostfrei
Rack à bouteilles, inox
Rack de botellas, inox

art. dim. cm. h. bot.
44060-50 56x10,5 15,5 6
44060-80 81x10,5 15,5 8
44060-99 107x10,5 15,5 10



Rastrelliera, inox
Speed rack, s/s
Flaschenregal, Edelstahl Rostfrei
Rack à bouteilles, inox
Rack de botellas, inox

art. dim. cm. h. bot.
44060-51 56x21 15,5 2x6



Valigia Barman, 20 pz
Barman's set, 20 pcs
Barman-Koffer, 20 Stk.
Mallette de barman, 20 pièces
Alfombra, 20 piezas

P

art.

14480-20

Comprende/Includes: 41479-05 boston shaker, 41480-05 shaker, 41503-22 pestello ghiaccio/ice beater, 41595-20 cucchiaino magico/magic spoon, 41603-00 colino cocktail/cocktail strainer, 41604-00 misurino cocktail/cocktail measuring cup, 41605-00 cucchiaino miscelatore/mixing spoon, 41606-00 spremilimone/lemon squeezer, 41606-01 spremilimone/lemon squeezer, 41606-02 spremilime/lime squeezer, 41608-04 tappo champagne/champagne stopper, 41699-06 cavatappi/corkscrew, 44058-10 tappo dosatore 10 ml/dispenser plug 10ml, 48280-02 levacapsule/bottle opener, 48280-56 coltello barman/barman knife, 48280-92 rigalimoni/lemon striper, 48280-96 pelarance/orange peeler, 52550-04 cucchiaino ghiaccio/ice spoon, 52550-36 cucchiaino bibita/cocktail spoon, 52550-55 molla ghiaccio/ice tong.



Supporto a parete, alluminio
Aluminum wall mounter bottle rack
Alu-Wandständer
Support mural en aluminium
Soporte mural, aluminio

art.	l. cm.	no. bottles
44056-04	41	4
44056-06	67	6



Supporto rotante da banco
Revolving bottle rack
Theken-Drehständer vollständig
Support pivotant de comptoir
Soporte giratorio

art.	h. cm.	no. bottles
44057-04	70	4
44057-06	70	6



Supporto bottiglia, alluminio
Standard aluminum support
Alu-Standard Ständer,
Support en aluminium
Soporte de botella, aluminio

art.
44056-01

Fissaggio universale, a ripiano o parete.
Universal fitting, shelf or wall mounting.

Dosatori non inclusi. - Dispensers not included.



Dosatore cromato
Chrome plated dispenser
Verchromter Dosierer
Doseur chromé
Dosificador cromado

art.	cl.
44055-20	20
44055-25	25
44055-30	30
44055-35	35
44055-40	40



Dosatore cromato
Chrome plated dispenser
Verchromter Dosierer
Doseur chromé
Dosificador cromado

art.	cl.
44055-10	10
44055-50	50



Tappo dosatore automatico
Automatic dispenser plug
Automatischer Portionierer
Bouchon doseur automatique
Bola dosificadora

art.	cl.
44058-20	20
44058-25	25
44058-30	30

BAR HAPPY HOUR BUFFET



Tappo dosatore automatico
Automatic dispenser plug
Automatischer Portionierer
Bouchon doseur automatique
Tapón dosificador automático

art.	cl.
44058-10	10
44058-40	40
44058-50	50



Tappo dosatore automatico
Automatic dispenser plug
Automatischer Portionierer
Bouchon doseur automatique
Tapón dosificador automático

art.	cl.
44115-15	15
44115-30	30



Tappo versatore sughero con chiusura inox
Bottle Pourer s/s with Cork Stopper
Ausgießer mit Naturkork und Kappe
Bouchon verseur liège avec clapet inox
Tapón vertedor con clerre inox

art.	u. pack
44111-02	2



Tappo versatore continuo
Free flow pourer
Permanentausgiesser
Bouchon verseur continu
Vertedor continuo

art.	u. pack	art.	u. pack
44110-01	12	44110-04	12
44110-02	12	44110-05	12
44110-03	12	44110-06	12



Tappo versatore continuo
Free flow pourer
Permanentausgiesser
Bouchon verseur continu
Vertedor continuo

art.	u. pack
44110-00	12



Tappo versatore dosatore
Measuring pourer
Dosierausgiesser
Bouchon verseur doseur
Tapón vertedor dosificador

art.	u. pack
44119-01	6
44119-02	6
44119-03	6
44119-04	6
44119-06	6



Tappo versatore dosatore
Measuring pourer
Dosierausgiesser
Bouchon verseur doseur
Tapón vertedor dosificador

art.
44114-01
44114-02
44114-03



Tappo metrico
Metric pourer
Portioniererausgiesser
Bouchon doseur
Caños dosificador

art.	u. pack	ml.	col.	art.	u. pack	ml.	col.
44118-10	6	10	●	44118-35	6	35	●
44118-20	6	20	●	44118-40	6	40	●
44118-25	6	25	●	44118-50	6	50	○
44118-30	6	30	●				



Preparare il versatore tenendo un dito sul beccuccio e girare rapidamente la bottiglia. Quando si versa, girare la bottiglia con un movimento morbido e regolare a 45-60 gradi. - Prime the pourer by holding a finger over the spout and quickly turning the bottle over. When pouring, turn the bottle in a smooth motion to a 45-60 degree angle.



Tappo spumante, inox
Champagne stopper, stainless steel
Sektflaschenstopfen, Edelstahl Rostfrei
Bouchon à champagne, inox
Tapón Champaña, inox

art.
41608-04



Tappo spumante Perlage, inox
Perlage stopper, stainless steel
Sektflaschenstopfen, Perlage, Edelstahl
Bouchon Perlage, inox
Tapón Champaña, inox

art.
41608-08



Tappo champagne, inox
Champagne bottle cap, stainless steel
Sektflaschenstopfen, Edelstahl Rostfrei
Bouchon à champagne, inox
Tapón Champaña, inox

art.
41608-00



Tappo spumante, inox
Champagne stopper, stainless steel
Sekflaschenstopfen, Edelstahl Rostfrei
Bouchon à champagne, inox
Tapón Champaña, inox

art.
56796-00



Tappo vino, inox
Wine stopper, stainless steel
Weinflaschenstopfen, Edelstahl Rostfrei
Bouchon à vin, inox
Tapón vino, inox

art.
41608-03



Apriscatole / levacapsule, inox
Can punch and bottle opener, s/s
Dosen-/Flaschenöffner, Edelstahl
Ouvre-boîte / décapsuleur, inox
Abrelatas/botellas, inox

art.
49860-00



Levacapsule nichelato
Bottle opener, nickelplated
Flaschenöffner, vernickelt
Décapsuleur, nickelé
Abrebotellas, niquelado

art.
41699-03



Levacapsule, inox
Bottle opener, stainless steel
Flaschenöffner, Edeltall Rostfrei
Décapsuleur, inox
Abrebotellas, inox

art. dim. cm.
41699-04 11x4



Pompa sottovuoto per vino
Vacuum pump wine preserver
Wein-Vakuum-Pumpe
Pompe vacuum à vin
Bomba vacío vino

art.
41499-00

Un sistema sorprendente per preservare i vini e mantenerne integro l'aroma. Maneggevole e facile da usare. Estrae l'ossigeno bloccando il processo di ossidazione. Fornito con 2 tappi in silicone, riutilizzabili. Un must per gli amanti del vino - An amazing new way to preserve wines. It pumps out the oxygen that turns open bottles of wine into vinegar. Just place the pump over the reusable stopper and, in one simple step, draw all the air out of the bottle and vacuum seal it to enjoy another day. A must for the wine lover! Easy to use and handy for keeping the bloom on your favorite vintage.



Levacapsule, inox
Bottle opener, stainless steel
Flaschenöffner, Edeltall Rostfrei
Décapsuleur, inox
Abrebotellas, inox

art. dim. cm.
41699-12 11x4



Fondina per levacapsule
Bar blade holster with belt clip
Flaschenöffner-Halter
Etui pour décapsuleur
Funda para abrebotellas

art.
41699-13



Cavatappi con raccoglitalpi, inox
Bottle opener with collector box, s/s
Flaschenöffner mit Stöpsel-Behälter
Décapsuleur avec boîte récupératrice
Abridor con recojedor de chapas

art. dim. cm. h.
48223-00 10,5x7,2 30



Cavatappi, plastica
Plastic lever corkscrew
Korkenzieher, kunststoff
Tire-bouchon, plastique
Sacachorcros, plastico

art.
49858-01



Cavatappi, cromato
Metal lever corkscrew
Korkenzieher, verchromt
Tire-bouchon, chromé
Sacachorcros, cromado

art.
49858-00



Set cavatappi cameriere
Waiter's corkscrew case
Kellner Korkenzieher-Koffer
Mallette tire-bouchon sommelier
Maletín sacacorchos sumiller

art.
49858-06

BAR HAPPY HOUR BUFFET



Taglia capsula
Foil cutter
Folienschneider
Coupe-capsule
Cortacápsulas

art.
49858-07



Cavatappi cameriere
Waiter's corkscrew
Kellner Korkenzieher
Tire-bouchon sommelier
Sacachorcos multiuso

art.
41699-08



Cavatappi cameriere
Waiter's corkscrew
Kellner Korkenzieher
Tire-bouchon sommelier
Sacachorcos multiuso

art.
41699-06



Cavatappi da parete
Wall mounted uncorking machine
Wand-Korkenzieher
Tire-bouchon à paroi
Sacacorchos mural

art.	kg.
49857-00	2,8
49859-00	2,7



Cavatappi a doppia leva
Winged corkscrew
Korkenzieher mit Doppelhebel
Tire-bouchon à double levier
Sacacorchos a doble palanca

art.
41699-10



Cavatappi a doppia leva
Winged corkscrew
Korkenzieher mit Doppelhebel
Tire-bouchon à double levier
Sacacorchos a doble palanca

art.
41699-11



Cavatappi con dotazione standard verme 49857-AA per estrazione di tappi in sughero. Per tappi in acrilico si raccomanda l'utilizzo del verme 49857-AB da ordinarsi separatamente. - Corkscrew equipped with standard thread item 49857-AA to uncork bottles with normal corks. For acrylic corks we recommend thread item 49857-AB to be ordered separately.



Porta panini, PS
Sandwich case, PS
Brötchen-/ Snackdispenser, PS
Présentoir à sandwich, PS
Vitrina bocadillos, PS

art.	dim. cm.	h.
47096-06	60x19,5	8



Vetrina da banco, PS
Showcase, PS
Vitrine für Verkaufstheke, PS
Vitrine à comptoir, PS
Vitrina, PS

art.	dim. cm.	h.
47096-63	63,5x25	25



Vassoio per vetrina, inox
Tray for showcase, stainless steel
Tablett für Vitrine, Edelstahl Rostfrei
Plateau à vitrine, inox
Bandeja para vitrina, inox

art.	dim. cm.	h.
47096-60	60x22	2



Vetrina da banco, plexiglas
Showcase, plexiglas
Vitrine für Verkaufstheke, Plexiglas
Vitrine à comptoir, plexiglas
Vitrina, plexiglas

art.	dim. cm.	h.
41472-30	60x37	36



Vetrina brioche, plexiglas
Showcase, plexiglas
Vitrine für Brioche, Plexiglas
Vitrine brioche, plexiglas
Vitrina brioche, plexiglas

art.	dim. cm.	h.
41472-31	50x33	53



Vetrina da banco, plexiglas
Showcase, plexiglas
Vitrine für Verkaufstheke, Plexiglas
Vitrine à comptoir, plexiglas
Vitrina, plexiglas

art.	dim. cm.	h.
41472-32	37x31	31



Vetrina da banco, 2 piani
Showcase, 2 tiers
Vitrine für Verkaufstheke, doppeldecker
Vitrine à comptoir, 2 étages
Vitrina, doble

Contenitore universale, impilabile
Sweet box, stackable
Universalbox, stapelbar
Boîte, empilable
Exhibidor, apilable

art.	dim. cm.	h.
47091-01	44x32	20,5
47091-02	44x32	44,0

art.	dim. cm.	h.
47090-23	23x14,5	15

Apertura doppio fronte. Forniti con vassoi inox e eutettici. - *Double side opening. Equipped with stainless steel tray and coolers.*



Piatto torta, melamina
Cake tray, melamine
Tortenplatte, Melamin
Plat gâteau, melamine
Bandeja pasteles, melamine

art.	Ø cm.	h.
44845-31	31	4



Piatto tondo, melamina
Round dish, melamine
Platte, rund, Melamin
Plat rond, melamine
Bandeja redonda, melamine

art.	Ø cm.	h.
44845-38	38	2



Coperchio roll-top
Roll-top cover
Rolltophaube
Couvercle roll-top
Campana roll-top

art.	Ø cm.	h.
41447-38	38	20



Cloche, PS
Dome cover, PS
Abdeckhaube, PS
Cloche, PS
Campana, PS

art.	Ø cm.	h.
41414-30	30	9,5



Alzata torta, inox
Swivel cake stand, stainless steel
Tortenplatte drehbar, Edelstahl Rostfrei
Gueridon pâtissier tournante, inox
Pedestal giratorio para tartas, inox

art.	Ø cm.	h.
47101-31	30,5	9



Cloche, PS
Dome cover, PS
Abdeckhaube, PS
Cloche, PS
Campana, PS

art.	Ø cm.	h.
41414-30	30	11,5



Tortiera con coperchio, acrilico
 Cake tray with cover, acrylic
 Tortenplatte mit Dekkel, Acryl
 Plateau à tarte avec couvercle, acrylique
 Bandeja tartas con tapa, acrílico

art.	Ø cm.	h.
44947-06	32	15



Piatto tondo, melamina
 Round dish, melamine
 Platte, rund, Melamin
 Plat rond, melamine
 Bandeja redonda, melamine

art.	Ø cm.	h.
44845-37	37	2,5



Cloche, PS
 Dome cover, PS
 Abdeckhaube, PS
 Cloche, PS
 Campana, PS

art.	Ø cm.	h.
41414-33	33	12



Alzata torta, inox 18-8
 Cake stand, stainless steel
 Tortenplatte, Edelstahl Rostfrei
 Gueridon pâtissier, inox
 Pedestal para tartas, inox

art.	Ø cm.	h.
41537-34	34,5	13,5



Campana, PS
 Dome cover, PS
 Frischhalte-Haube, PS
 Cloche, PS
 Cubierta, PS

art.	Ø cm.	h.
41537-33	33	12,5



Alzata torta
 Cake stand
 Tortenplatte
 Gueridon pâtissier
 Pedestal para tartas

art.	Ø cm.	h.
44873-08	31	8
44873-16	31	16



Alzata torta
 Cake stand
 Tortenplatte
 Gueridon pâtissier
 Pedestal para tartas

art.	dim. cm.	h.
44874-08	31x31	8
44874-16	31x31	16





P

Flacone dosatore in polietilene
Squeeze bottle, polyethylene
Dosierflasche, PE
Flacon doseur, polyéthylène
Frasco dosificador, polietileno

art.	ml.
41526-R1	240
41526-R2	360
41526-R3	720



P

Flacone dosatore in polietilene
Squeeze bottle, polyethylene
Dosierflasche, PE
Flacon doseur, polyéthylène
Frasco dosificador, polietileno

art.	ml.
41526-B1	240
41526-B2	360
41526-B3	720



P

Flacone dosatore in polietilene
Squeeze bottle, polyethylene
Dosierflasche, PE
Flacon doseur, polyéthylène
Frasco dosificador, polietileno

art.	ml.
41526-G1	240
41526-G2	360
41526-G3	720



Dosatore, acrilico
Dispenser, acrylic
Dosierspender, Acryl-Behälter
Doseur, acrylique
Dispensador, acrílico

art.	ml.
47609-02	250
47609-03	350
47609-09	950
47609-13	1350



Dosatore, acrilico
Dispenser, acrylic
Dosierspender, Acryl-Behälter
Doseur, acrylique
Dispensador, acrílico

art.	ml.
47609-04	375
47609-07	750
47609-12	1250
47609-16	1650



Dosatore, inox
Lever dispenser, stainless steel
Hebeldosierspender, Edelstahl Rostfrei
Distributeur à manette, inox
Dispensador, inox

art.	Ø cm.	h.
41528-21	21	22,5
41528-22	22	18,0

Per bidone da kg 5. - Suitable for 5 kg bucket.



Busta porta toast, 2 pz, icflon
Bag for toaster, 2 pcs, icflon
Toast-Tasche, icflon
Sac à toast, icflon
Bolsa para tostadas, icflon

art.	dim. cm.
41682-17	17x20



Busta per hamburger, 2 pz, icflon
Bag for grill, 2 pcs, icflon
Hamburger-Tasche, icflon
Sac à hamburger, icflon
Bolsa para hamburger, icflon

art.	dim. cm.
41682-20	20x20



Portagiornale, legno
Newspaper stick, wood
Zeitungshalter aus Holz
Canne à journaux, bois
Varilla portaperiodico, madera

art.
48287-18
48287-19

Riutilizzabili almeno 50 volte. Lavabili in lavastoviglie. Ideali per intolleranze alimentari.
Reusable over 50 times. Dishwasher proof. Ideal for food intolerances.

VASSOI - TRAYS

VASSOI IN LAMINATO, ANTISCIVOLO - NON-SKID LAMINATED TRAYS

Vassoi in laminato con superficie di gomma antiscivolo, eccellente resistenza alle sostanze chimiche, sbalzi termici, graffi e rottura. Buona resistenza alle macchie. Lavabili in lavastoviglie con periodicità normale. Resistenza alla temperatura: da -10% a +100°C. - Per motivi tecnici di stampa i colori indicati potrebbero non corrispondere all'originale. - *Non-skid surface trays with laminated bottom, excellent resistance to chemicals, sudden temperature changes, scratches and breakage. Good resistance to spots. Dishwasher safe under normal frequency. Temperature resistance: from -10% to +100°C. Due to the catalog printing process, the colors shown may not be exact.*

● **R = Rosso** - Red ● **B = Nero** - Black ● **M = Marrone** - Brown



Vassoio rettangolare Tray, rectangular Serviertablett, rechteckig Plateau rectangulaire Bandeja rectangular				Vassoio rettangolare Tray, rectangular Serviertablett, rechteckig Plateau rectangulaire Bandeja rectangular				Vassoio rettangolare Tray, rectangular Serviertablett, rechteckig Plateau rectangulaire Bandeja rectangular				Vassoio rotondo Tray, round Serviertablett, rund Plateau rond Bandeja redonda		
art.	dim. cm.		col	art.	dim. cm.		col	art.	dim. cm.		col	art.	Ø cm.	col
41830R37	37x53	Euronorm	●	41831R28	20x28		●	41831B28	20x28		●	41833R43	43	●
41830R53	32,5x53	GN 1/1	●	41831R46	36x46		●	41831B43	33x43		●	41833M32	32	●
41830B37	37x53	Euronorm	●	41831R61	43x61		●	41831B46	36x46		●	41833M38	38	●
41830B53	32,5x53	GN 1/1	●	41831M28	20x28		●	41831B61	43x61		●	41833B32	32	●
41830M37	37x53	Euronorm	●									41833B38	38	●
41830M53	32,5x53	GN 1/1	●									41833B43	43	●

VASSOI IN LAMINATO - LAMINATED TRAYS

Vassoi in laminato, superficie liscia, buona resistenza alle sostanze chimiche, macchie, sbalzi termici, graffi e rottura. Lavabili in lavastoviglie con periodicità normale. Resistenza alla temperatura: da -10% a +100°C. - *Laminated trays, smooth surface, good resistance to chemicals, spots, sudden temperature changes, scratches and breakage. Dishwasher safe under normal frequency. Temperature resistance: from -10% to +100°C.*

● **T = Tek** - Teack ● **N = Noce** - Walnut

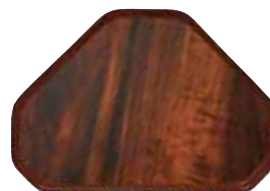

Vassoio rettangolare Tray, rectangular Serviertablett, rechteckig Plateau rectangulaire Bandeja rectangular				Vassoio rettangolare Tray, rectangular Serviertablett, rechteckig Plateau rectangulaire Bandeja rectangular				Vassoio trapezoidale Trapezium tray Serviertablett "Trapez" Plateau trapézoidal Bandeja trapézoidal				Vassoio rotondo Tray, round Serviertablett, rund Plateau rond Bandeja redonda		
art.	dim. cm.		col	art.	dim. cm.		col	art.	dim. cm.		col	art.	Ø cm.	col
41840T37	37x53	Euronorm	●	41841T27	27x38		●	41845N36	36x52		●	41843T32	32	●
41840T53	32,5x53	GN 1/1	●	41841T46	36x46		●					41843T38	38	●
41840N37	37x53	Euronorm	●	41841T61	43x61		●					41843N32	32	●
41840N53	32,5x53	GN 1/1	●	41841N27	27x38		●					41843N38	38	●
				41841N46	36x46		●							
				41841N61	43x61		●							

VASSOI IN POLIESTERE - POLYESTER TRAYS

Vassoi in poliestere rinforzato con fibra di vetro, superficie liscia, buona resistenza alle sostanze chimiche, macchie, sbalzi termici, graffi e rottura. Lavabili in lavastoviglie con periodicità normale. Resistenza alla temperatura: da -40% a +130°C. - Per motivi tecnici di stampa i colori indicati potrebbero non corrispondere all'originale. - Polyester trays fiber glass reinforced, smooth surface, good resistance to chemicals, spots, sudden temperature changes, scratches and breakage. Dishwasher safe under normal frequency. Temperature resistance: from -40% to +130°C. Due to the catalog printing process, the colors shown may not be exact.

G = Grigio - Grey

T = Terrazzo - Terrace



Vassoio rettangolare
Tray, rectangular
Serviertablett, rechteckig
Plateau rectangulaire
Bandeja rectangular

Vassoio rettangolare
Tray, rectangular
Serviertablett, rechteckig
Plateau rectangulaire
Bandeja rectangular

Vassoio rettangolare
Tray, rectangular
Serviertablett, rechteckig
Plateau rectangulaire
Bandeja rectangular

art.	dim. cm.	col.
41851G46	36x46	●
41851T46	36x46	●

art.	dim. cm.	col.
41850G53	32,5x53 GN 1/1	●
41850T53	32,5x53 GN 1/1	●

art.	dim. cm.	col.
41850G37	37x53 Euronorm	●
41850T37	37x53 Euronorm	●



Vassoio rettangolare, PP
Tray, rectangular, PP
Serviertablett, rechteckig, PP
Plateau rectangulaire, PP
Bandeja rectangular, PP

Vassoio rettangolare, PP
Tray, rectangular, PP
Serviertablett, rechteckig, PP
Plateau rectangulaire, PP
Bandeja rectangular, PP

Vassoio room service, noce
Room service tray, walnut
Zimmerservice-Tablett, Nussbraun
Plateau room-service, noyer
Bandeja roo service, nuez

art.	dim. cm.
41860-36	27x36,5
41860-43	30,7x43,5
41860-47	35,5x47

art.	dim. cm.
41861-44	30,7x44

art.	dim. cm.
19901-35	52x35
19901-40	60x40
19901-47	71x47



Stand per vassoi, cromato
Tray stand, chromed
Tablett-Träger, verchromt
Porte plateaux, chromé
Soporte para bandejas, cromado

Stand per vassoi, legno
Tray stand, wood
Tablett-Träger, Holz
Porte plateaux, bois
Soporte para bandejas, mader

art.	dim. cm.	h.
44093-00	38x52	80

art.	dim. cm.	h.
44093-01	42x43	82



N

Carrello portavassoi, filo cromato
Tray serving trolley, chromed wire
Tablettwagen, Metall verchromt
Chariot de service plateaux, chromé
Carrito para bandejas, cromado

art.	dim. cm.	h.	kg.
44094-20	60,5x40	99	7,5



Ideale per il servizio di mini colazioni.
Ideal for quick breakfast service.
Per vassoi/for trays: cm. 46x36

Il Vassoio Wave è amico dell'ambiente. Design ergonomico e moderno con comodi bordi. Finitura ruvida naturale. Non solo è confortevole in mano ma è anche unico ed elegante allo stesso tempo. Può essere utilizzato come piatto di presentazione. Wave è disponibile in 3 versioni naturali che rispecchiano a fondo l'aspetto ecologico del vassoio. Idoneo al lavaggio in lavastoviglie (asciugare prima di impilare).

Wave is an environmentally friendly Tray. 90% ecological, manufactured from renewable materials. Modern, ergonomic design with comfortable edges. Natural rough finish. Not only comfortable in hands but unique and elegant at the same time. It can be used as showplate. Wave is available in 3 versions that fully reflect its ecological aspect. Suitable for dishwashers (dry before stacking).

● Light Wood

● Grey Wood

● Dark Wood

N

70% Cartone Rigido, 30% Bioresine
70% Rigid Carton, 30% Bioresins



Vassoio rettangolare
Tray, rectangular
Serviertablett, rechteckig
Plateau rectangulaire
Bandeja rectangular

Vassoio rettangolare
Tray, rectangular
Serviertablett, rechteckig
Plateau rectangulaire
Bandeja rectangular

Vassoio rettangolare
Tray, rectangular
Serviertablett, rechteckig
Plateau rectangulaire
Bandeja rectangular

art.	dim. cm.	u. pack	col.
41324-01	43x23	25	●
41324-11	43x23	25	●
41324-21	43x23	25	●

art.	dim. cm.	u. pack	col.
41324-02	43x33	25	●
41324-12	43x33	25	●
41324-22	43x33	25	●

art.	dim. cm.	u. pack	col.
41324-03	46x36	25	●
41324-13	46x36	25	●
41324-23	46x36	25	●



Bicchiere whiskey, PC
Whiskey glass, PC
Whiskey Gläser, PC
Verre à whiskey, PC
Vaso para whiskey, PC

art.	Ø cm.	h.	ml.	u.pack
44940-01	8,5	9,5	420	6



Bicchiere succo, PC
Juice glass, PC
Fruchtsaft-Gläser, PC
Verre à jus, PC
Vaso para zumo, PC

art.	Ø cm.	h.	ml.	u.pack
44940-02	7,5	15,5	460	6



Boccali birra, PC
Beer glasses, PC
Bier-Gläser, PC
Verre à bière, PC
Vaso para cerveza, PC

art.	Ø cm.	h.	ml.	u.pack
44940-06	8	23	450	6



Boccali birra, MS
Beer glasses, MS
Bier-Gläser, MS
Verre à bière, MS
Vaso para cerveza, MS

art.	Ø cm.	h.	ml.	u.pack
44940-08	9	16	500	6



Bicchiere margarita, PC
Margarita glass, PC
Margarita-Gläser, PC
Verre à margarita, PC
Vaso margarita, PC

art.	Ø cm.	h.	ml.	u.pack
44940-10	12	18	300	6



Bicchiere martini, PC
Martini glass, PC
Martini-Gläser, PC
Verre à martini, PC
Vaso martini, PC

art.	Ø cm.	h.	ml.	u.pack
44940-11	12	17	240	6



P

Bicchiere vino, PC
Wine glass, PC
Wein-Gläser, PC
Verre à vin, PC
Vaso vino, PC

art.	Ø cm.	h.	ml.	u.pack
44940-12	7	21	300	6



P

Bicchiere vino, PC
Wine glass, PC
Wein-Gläser, PC
Verre à vin, PC
Vaso vino, PC

art.	Ø cm.	h.	ml.	u.pack
44940-13	7	19	300	6



P

Bicchiere spumante, PC
Champagne glass, PC
Sekt-Gläser, PC
Flûte, PC
Vaso champaña, PC

art.	Ø cm.	h.	ml.	u.pack
44940-14	5	22	180	6



P

Bicchiere, PC
Mixing glass, PC
Gläser, PC
Verre, PC
Vaso, PC

art.	Ø cm.	h.	ml.	u.pack
44940-16	9	16	540	6



P

Bicchiere whiskey/rocks, PC
Whiskey/rocks glass, PC
Whiskey-/Rocks-Gläser, PC
Verre à whiskey/rocks, PC
Vaso para whiskey/rocks, PC

art.	Ø cm.	h.	ml.	u.pack
44940-17	9,0	12,0	420	6



P

Bicchiere whiskey/rocks, PC
Whiskey/rocks glass, PC
Whiskey-/Rocks-Gläser, PC
Verre à whiskey/rocks, PC
Vaso para whiskey/rocks, PC

art.	Ø cm.	h.	ml.	u.pack
44940-18	8,5	11,5	420	6



P

Bicchiere, PC
Cooler, PC
Gläser, PC
Verre, PC
Vaso, PC

art.	Ø cm.	h.	ml.	u.pack
44940-19	8	17	540	6



P

Bicchiere, PC
Tumbler, PC
Trinkbecher, PC
Gobelet, PC
Vaso, PC

art.	Ø cm.	h.	ml.	u.pack
44940-24	7,5	12,5	360	6
44940-25	8,0	13,5	480	6
44940-26	8,5	16,0	660	6



P

Bicchiere, PC
Tumbler, PC
Trinkbecher, PC
Gobelet, PC
Vaso, PC

art.	Ø cm.	h.	ml.	u.pack
44940-32	7,5	12,5	360	6
44940-33	8,0	13,5	480	6
44940-34	8,5	16,0	660	6



P

Bicchiere zigrinato, SAN
Clear tumbler, SAN
Trinkbecher, SAN
Gobelet transparent, SAN
Vaso transparente, SAN

art.	Ø cm.	h.	ml.	u.pack
44990-15	5,5	9,5	150	6
44990-24	6,5	10,0	240	6
44990-29	7,0	11,0	290	6
44990-36	7,5	13,0	360	6
44990-48	8,0	15,0	480	6



N

Bicchiere acqua, PC
Water tumbler, PC
Wasserglas, PC
Verre à eau, PC
Vaso agua, PC

art.	Ø cm.	h.	ml.	u. pack
44871-20	7,0	7,0	170	10
44871-21	7,0	10,2	250	10
44871-22	7,8	11,4	350	10

Impilabile. - Stackable.



N

Coperchio con beccuccio, PP
Cover with spout, PP
Deckel mit Ausguss, PP
Couvercle avec bec, PP
Tapa con boquilla, PP

art.	Ø cm.	u. pack
44871-23	7	50

BAR HAPPY HOUR BUFFET



P

Bicchieri cocktail, MS
Cocktail glasses, MS
Cocktail Gläser, MS
Verres à cocktail, MS
Vasos para cocktail, MS

art.	Ø cm.	h.	u.pack
44942-01	8	21	6



P

Bicchieri cocktail, MS
Cocktail glasses, MS
Cocktail Gläser, MS
Verres à cocktail, MS
Vasos para cocktail, MS

art.	Ø cm.	h.	u.pack
44942-02	11	21	6



P

Bicchieri martini, MS
Martini glasses, MS
Martini-Gläser, MS
Verres à martini, MS
Vasos martini, MS

art.	Ø cm.	h.	u.pack
44942-03	10,5	20	6



P

Bicchieri cocktail, MS
Cocktail glasses, MS
Cocktail Gläser, MS
Verres à cocktail, MS
Vasos para cocktail, MS

art.	Ø cm.	h.	u.pack
44942-04	7,5	23	6



P

Bicchieri margarita, MS
Margarita glasses, MS
Margarita-Gläser, MS
Verres à margarita, MS
Vasos margarita, MS

art.	Ø cm.	h.	u.pack
44942-05	12	17,5	6



Mescolatore
Stirrer
Rührer
Agitateur
Stick agitador

art.	l. cm.	u.pack
48300-20	18,5	500



Mescolatore
Stirrer
Rührer
Agitateur
Stick agitador

art.	l. cm.	u.pack
48300-21	18,5	200



Mescolatore
Stirrer
Rührer
Agitateur
Stick agitador

art.	l. cm.	u.pack
48300-22	18,5	200



Mescolatore
Stirrer
Rührer
Agitateur
Stick agitador

art.	l. cm.	u.pack
48300-23	18,5	200

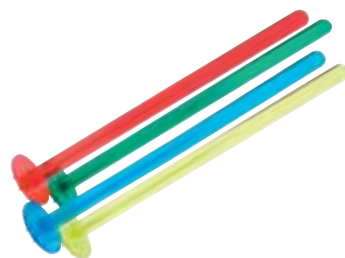

Mescolatore
Stirrer
Rührer
Agitateur
Stick agitador

art.	l. cm.	u.pack
48300-24	17	50



Spilloncini plastica
Plastic picks
Kunststoff-Stocher
Pics en plastique
Picos plástico

art.	l. cm.	u.pack
48300-25	8,5	1000



Decorazione gelato
Ice cream decoration
Eiskremedekoration
D cor   glace
Decoraci n para helado

Decorazione gelato
Ice cream decoration
Eiskremedekoration
D cor   glace
Decoraci n para helado

art. u.pack
48300-27 144

art. u.pack
48300-28 144



Spiedini bamboo
Bamboo skewers
Bambus-Fleischspiess
Brochettes en bambou
Palillos de bamb 

Spiedini bamboo
Bamboo skewers
Bambus-Fleischspiess
Brochettes en bambou
Palillos de bamb 

Cannucce
Straws
Trinkhalme
Pailles
Ca as

art. l. cm. pz./pcs.
48300-31 10,5 200

art. l. cm. pz./pcs.
48300-32 10,5 200
48300-33 15,0 100

art.   mm. l. cm. u.pack
48300-34 8 15 250
48300-35 8 25 250

Nero. - Black.



Cannucce
Straws
Trinkhalme
Pailles
Ca as

Cannucce
Straws
Trinkhalme
Pailles
Ca as

Cannucce
Straws
Trinkhalme
Pailles
Ca as

art.   mm. l. cm. u.pack
48300-36 5 24 250

art.   mm. l. cm. u.pack
48300-37 6 19,5 500

art.   mm. l. cm. u.pack
48300-38 6 15 250

Nero. - Black.

Colori assortiti. - Assorted colors.

Colori assortiti. - Assorted colors.

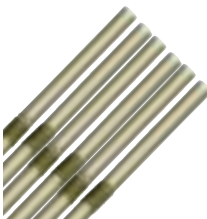
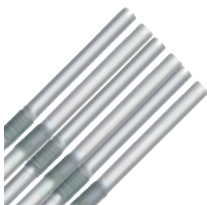

Cannucce
Straws
Trinkhalme
Pailles
Ca as

Cannucce
Straws
Trinkhalme
Pailles
Ca as

Cannucce
Straws
Trinkhalme
Pailles
Ca as

art.   mm. l. cm. u.pack
48300-39 6 19,5 500

art.   mm. l. cm. u.pack
48300-40 6 19,5 500

art.   mm. l. cm. u.pack
48300-41 4 10 1000

Argento. - Silver.

Oro. - Gold.

Colori assortiti. - Assorted colors.

BAR HAPPY HOUR BUFFET



Stuzzicadenti in legno
Wooden toothpicks
Holz-Zahnstocher
Cure-dents en bois
Palillos

art.	l. cm.	u.pack
48306-01	9	1000



Stuzzicadenti in legno
Wooden toothpicks
Holz-Zahnstocher
Cure-dents en bois
Palillos

art.	l. cm.	u.pack
48306-02	6	1000

Una punta. - One tip.



Spiedini legno
Wooden skewers
Holz-Fleischspieß
Brochettes en bois
Pinchos madera

art.	l. cm.	u.pack
48307-01	15	100
48307-02	20	100
48307-03	25	100
48307-04	30	100



Vassoietto party
Party tray
Party-Tablett
Plateau party
Bandeja party

art.	dim. cm.	
44049-01	25x18	nero-black
44049-02	25x18	bianco-white



Clip reggibicchiera, PC
Glass clip holder, PC
Glashalter
Clip porte-verre
Soporte para vidrio

art.	u.pack
44048-99	100

La comoda clip per buffet e party in piedi. Adattabile a piatti di porcellana con bordi diversi, ideale per piatti a falda stretta e anche quadrati. Aggancian-dola al bordo del piatto si potrà inserire il bicchiere e avere sempre una mano libera. - *The handy clip for buffet and party. Adaptable to china plates with different edges, suitable also for dishes with narrow rim and square dishes too. Attaching it to the edge of the plate you can rest your glass and still have a free hand.*



Forchettina plastica, monouso
Small fork, plastic, disposable
Gabel, klein
Petite fourchette
Tenedor

art.	l. cm.	u.pack
48362-01	8,5	500



Cucchiaino plastica, monouso
Small spoon, plastic, disposable
Löffel, klein
Petit cuiller
Cucharita

art.	l. cm.	u.pack
48363-01	8,5	500



Spiedini plastica, monouso
Spits, plastic, disposable
Fleischspieß
Brochettes
Palos

art.	l. cm.	u.pack
48364-09	9	500
48364-12	12	500



Cucchiaino SAN, monouso
Small spoon, SAN, disposable
Löffel, klein, SAN
Petit cuiller, SAN
Cucharita, SAN

art.	l. cm.	u.pack
48345-02	12	24



Forchettina SAN, monouso
Small fork, SAN, disposable
Gabel, klein, SAN
Petite fourchette, SAN
Tenedor, SAN

art.	l. cm.	u.pack	
48345-04	12	24	nero-black



Forchettine party, inox
Party forks, stainless steel
Party-Gabel, Edelstahl Rostfrei
Fourchettes apéro, inox
Tenedores party, inox

art.	l. cm.	u.pack
62550B27	12,5	12
62550B29	12,5	12

P



Bicchierino, monouso
Small glass, disposable
Klein Glass
Petite verre
Bol pequeño

art.	Ø cm.	h.	ml.	u.pack
48353-01	8,5	6,5	120	100



Bicchierino, monouso
Small glass, disposable
Klein Glass
Petite verre
Bol pequeño

art.	Ø cm.	h.	ml.	u.pack
48354-01	4	8,5	70	100



Piattino, monouso
Small dish, disposable
Kleine Schale
Petite assiette
Platillo

art.	Ø cm.	h.	ml.	u.pack
48355-01	9	1,5	20	100



Ciotolina, monouso
Small bowl, disposable
Kleine Schale
Petit bol
Bol pequeño

art.	Ø cm.	h.	ml.	u.pack
48356-01	8,5	3	30	100



Ciotolina, monouso
Small bowl, disposable
Kleine Schale
Petit bol
Bol pequeño

art.	Ø cm.	h.	ml.	u.pack
48357-01	7,5	3	50	100



Ciotolina, monouso
Small bowl, disposable
Kleine Schale
Petit bol
Bol pequeño

art.	dim. cm.	h.	ml.	u.pack
48358-01	10,5x5	3	11	100



Piattino, monouso
Small dish, disposable
Kleine Schale
Petite assiette
Platillo

art.	Ø cm.	h.	ml.	u.pack
48359-01	6,5	1,5	15	100



Piattino, monouso
Small dish, disposable
Kleine Schale
Petite assiette
Platillo

art.	dim. cm.	h.	ml.	u.pack
48360-01	11x6,5	2	20	100



Piattino, monouso
Small dish, disposable
Kleine Schale
Petite assiette
Platillo

art.	dim. cm.	h.	ml.	u.pack
48361-01	11,5x10,5	1,5	30	100

BAR HAPPY HOUR BUFFET



P

Portasalatini, acrilico
Olive plate, acrylic
Salzgebäckständer, Acryl
Porte-appetizers, acrylique
Entremesera, acrílico

art.	dim. cm.	h.
44991-04	11,5x18	9,5



P

Portasalatini, acrilico
Swirl appetizer, acrylic
Salzgebäckständer, Acryl
Porte-appetizers, acrylique
Entremesera, acrílico

art.	dim. cm.	h.
44991-01	19x18	3



P

Portasalatini, acrilico
Olive plate, acrylic
Salzgebäckständer, Acryl
Porte-appetizers, acrylique
Entremesera, acrílico

art.	dim. cm.	h.
44991-03	27x13	3,5



P

Coppa punch con coperchio, acrilico
Punch bowl with lid, acrylic
Punchbowle mit Deckel, Acryl
Bol à punch avec couvercle, acrylique
Ponchero con tapa, acrílico

art.	Ø cm.	h.	lt.
44947-01	28	22,3	5,4



P

Ciotola aperitivi, acrilico
Hors d'oeuvre bowl, acrylic
Vorspeisenschale, Acryl
Bol hos d'oeuvres, acrylique
Entremesera, acrílico

art.	Ø cm.	h.
44947-05	28	23



P

Antipastiera, acrilico
Appetizer tray, acrylic
Vorspeisenteller, Acryl
Plateau hos d'oeuvres, acrylique
Entremesera, acrílico

art.	Ø cm.	h.
44947-02	42	6,5





P

Antipastiera con coperchio, acrilico
Appetizer tray with lid, acrylic
Vorspeisenteller mit Deckel, Acryl
Plateau hos d'oeuvres, acrylique
Entremesera con tapa, acrílico

art.	dim. cm.	h.
44947-08	36,5x36,5	17



P

Antipastiera acrilico con inserto inox
Acrylic appetizer tray with s/s plate
Vorspeisenteller, Acryl
Plateau hos d'oeuvres, acrylique
Entremesera, acrílico

art.	Ø cm.	h.
44947-04	36	7



P

Antipastiera con coperchio, acrilico
Appetizer tray with lid, acrylic
Vorspeisenteller mit Deckel, Acryl
Plateau hos d'oeuvres, acrylique
Entremesera con tapa, acrílico

art.	dim. cm.	h.
44947-09	50x29	20



Porta snack, acrilico
Snack holder, acrylic
Snack-Behälter, Acryl
Conteneur à snack, acrylique
Contenedor para snack, acrílico

art.	dim. cm.	h.
44947-07	15x20	5



Porta snack, inox
Snack holder, stainless steel
Snack-Behälter, Edelstahl
Conteneur à snack, inox
Contenedor para snack, inox

art.	Ø cm.	h.	lt.
41524-09	9	8,5	0,33



Porta snack, 4 pezzi, inox
Snack holder, 4 pcs, stainless steel
Snack-Behälter, 4er Set, Edelstahl
Conteneur à snack, 4 pièces, inox
Contenedor para snack, 4 pz, inox

art.	Ø cm.	h.	lt.
41524-04	7	6,5	0,15



Porta snack, inox
Snack holder, stainless steel
Snack-Behälter, Edelstahl
Conteneur à snack, inox
Contenedor para snack, inox

art.	dim. cm.	h.
41527-13	13x10,5	9/13,5



Porta snack, inox
Snack holder, stainless steel
Snack-Behälter, Edelstahl
Conteneur à snack, inox
Contenedor para snack, inox

art.	Ø cm.	h.
41523-08	8	7,5/9,5



BUFFET & PRESENTATION



Approfitta delle qualità della melamina!

I pratici pezzi a servire sono al 100% in pura melamina e offrono vantaggi che i Professionisti con il loro utilizzo quotidiano potranno apprezzare: di prima qualità, esteticamente assomiglia alla porcellana; estremamente resistente alla rottura, non produce schegge pericolose; superficie liscia e lucida; robusta e solida, lavabile in lavastoviglie e utilizzabile in frigo/freezer; resistente da -50°C a +100°C; non assorbe odori e sapori; ideale per una presentazione degli alimenti ecocompatibile ed igienica.

Take advantage of the merits (qualities) of melamine!

These practical serving pieces are 100% pure melamine and offer benefits that all Professionals will appreciate with the everyday use: top quality, looks like premium porcelain; extremely resistant to breakage; does not produce dangerous splinters; hard, glossy surface; sturdy and durable: dishwasher safe, suitable for refrigerator and freezer; resistant from -50 °C to +100 °C; does not absorb odors and flavors; ideal for an environment-friendly and hygienic food presentation.

Tutti i supporti sono forniti senza piatti e senza ciotole.
All stands are delivered without plates and bowls.

BAR HAPPY HOUR BUFFET BUFFET & PRESENTATION



Supporto cromato "Quadro S"
Serving stand, chrome plated
Serviergestell, hartverchromt
Présentoir, acier chromé
Soporte platos pastre, acero cromado

art.	dim. cm.	h.
44840-01	29x17	41

Per 3 piatti cm. 18x18 oppure 21x21.
For 3 plates cm. 18x18 or 21x21.

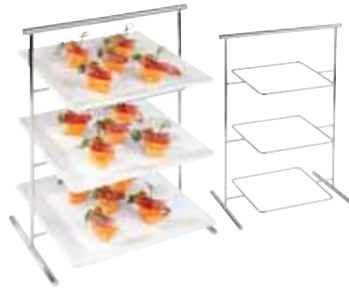

Supporto cromato "Quadro M"
Serving stand, chrome plated
Serviergestell, hartverchromt
Présentoir, acier chromé
Soporte platos pastre, acero cromado

art.	dim. cm.	h.
44840-02	33x21	44

Per 3 piatti cm. 21x21 oppure 26,5x26,5.
For 3 plates cm. 21x21 or 26,5x26,5.



Supporto cromato "Buffet"
Serving stand, chrome plated
Serviergestell, hartverchromt
Présentoir, acier chromé
Soporte platos pastre, acero cromado

art.	dim. cm.	h.
44840-03	37x21	44

Per 3 piatti cm. 30x21.
For 3 plates cm. 30x21.



Supporto cromato "Buffet"
Serving stand, chrome plated
Serviergestell, hartverchromt
Présentoir, acier chromé
Soporte platos pastre, acero cromado

art.	dim. cm.	h.
44840-20	45x37	72

Per 3 piatti cm. 37x37.
For 3 plates cm. 37x37.

N



Supporto cromato
Serving stand, chrome plated
Serviergestell, hartverchromt
Présentoir, acier chromé
Soporte platos pastre, acero cromado

art.	dim. cm.	h.
44840-05	37,5x37,5	50

Per piatti di 3 diverse misure: cm. 21x21-
26,5x26,5-37x37. - For plates in 3 different
sizes: cm. 21x21-26,5x26,5-37x37.



Supporto cromato "GN"
Serving stand, chrome plated
Serviergestell, hartverchromt
Présentoir, acier chromé
Soporte platos pastre, acero cromado

art.	dim. cm.	h.
44840-04	63x27	44,5

Per 2 piatti cm. 53x32,5 oppure 4 piatti
cm. 53x16,2. - For 2 plates cm. 53x32,5 or
4 plates cm. 53x16,2.



Supporto cromato
Serving stand, chrome plated
Serviergestell, hartverchromt
Présentoir, acier chromé
Soporte, acero cromado

art.	ø cm.	h.	bowls
44840-25	35	46	4xø14

Senza ciotole - Without bowls.
Ciotole - Bowls : 44837-05, 44837B05.

N



Supporto cromato
Serving stand, chrome plated
Serviergestell, hartverchromt
Présentoir, acier chromé
Soporte, acero cromado

art.	ø cm.	h.	bowls
44840-26	48	46	4xø20

Senza ciotole/ceste - Without bowls/baskets.
Ciotole - Bowls: 44837-20, 44837B20.
Ceste - Baskets: 42990-20, 42990M20, 42290N20

N



Supporto cromato
Serving stand, chrome plated
Serviergestell, hartverchromt
Présentoir, acier chromé
Soporte, acero cromado

art.	ø cm.	h.	bowls
44840-27	22	59	12xø6
44840-28	22	33	6xø6

Forniti senza vetri - Delivered without glasses.
Vasetti idonei - Suitable glasses:
41589C08, 41589C16, 41589-08, 41589-14, 41589-16.
vedi pag. 276 - see page 276

N

BAR HAPPY HOUR BUFFET



Vasi Gourmet, set 12 pezzi
Gourmet glasses, 12 pcs.
Gourmet-Gläser, 12er Set
Set 12 verres Gourmet
Juego 12 vasos Gourmet



art.	ø cm.	h.	ml.
41589C08	6	5,5	80
41589C16	6	8,0	160

Adatti ai supporti - Suitable for stand:
44840-27 & 44840-28



Vassoio sushi, melamina
Sushi tray, melamine
Sushiplatte, Melamin
Plateau sushi, melamine
Bandeja sushi, melamina

art.	dim. cm.	
44842-31	31x10,5	bianco/white
44842-53	53x18	bianco/white
44842-35	35,5x18	bianco/white
44842-30	30x21	bianco/white
44842B53	53x18	nero/black
44842B31	31x10,5	nero/black



Vassoio GN 1/1, melamina
GN 1/1 tray, melamine
GN 1/1-Tablett, Melamin
Plateau GN 1/1, melamine
Bandeja GN 1/1, melamina

art.	dim. cm.	
44843-11	53x32,5	bianco/white
44843-12	32,5x26,5	bianco/white
44843-13	32,5x17,5	bianco/white
44843-14	26,5x16,2	bianco/white
44843B11	53x32,5	nero/black
44843B12	32,5x26,5	nero/black
44843B13	32,5x17,5	nero/black
44843B14	26,5x16,2	nero/black



Vassoio quadro, melamina
Tray, square, melamine
Tablett, quadratisch, Melamin
Plateau carré, melamine
Bandeja, cuadrada, melamina

art.	dim. cm.	
44841-18	18x18	bianco/white
44841-21	21x21	bianco/white
44841-26	26,5x26,5	bianco/white
44841-37	37x37	bianco/white
44841-51	51x51	bianco/white
44841B51	51x51	nero/black



Vassoio GN 2/4, melamina
GN 2/4 tray, melamine
GN 2/4-Tablett, Melamin
Plateau GN 2/4, melamine
Bandeja GN 2/4, melamina

art.	dim. cm.	
44843-24	53x16,2	bianco/white
44843B24	53x16,2	nero/black



Piatto tondo, melamina
Round dish, melamine
Platte, rund, Melamin
Plat rond, melamine
Bandeja redonda, melamina

art.	ø cm.	
44845-51	51	bianco/white
44845-30	30	bianco/white
44845-41	41	bianco/white
44845B51	51	nero/black



41447-38

Piatto tondo, melamina
Round dish, melamine
Platte, rund, Melamin
Plat rond, melamine
Bandeja redonda, melamina

art.	ø cm.	h.	col.
44845-38	38	2	○
44845B38	38	2	●



41414-33

Piatto tondo, melamina
Round dish, melamine
Platte, rund, Melamin
Plat rond, melamine
Bandeja redonda, melamina

art.	ø cm.	h.
44845-37	37	2,5



41414-30

Piatto torta, melamina
Cake tray, melamine
Tortenplatte, Melamin
Plat gâteau, melamine
Bandeja pasteles, melamina

art.	ø cm.	h.
44845-31	31	4



Ciotola quadra, melamina
Square bowl, melamine
Schüssel, quadratisch, Melamin
Bol carré, melamine
Bol cuadrado, melamina

art.	dim. cm.	
44847-09	9x9	bianco/white
44847-13	12,5x12,5	bianco/white
44847-20	19x19	bianco/white



Ciotola quadra, melamina
Square bowl, melamine
Schüssel, quadratisch, Melamin
Bol carré, melamine
Bol cuadrado, melamina

art.	dim. cm.	
44847B09	9x9	nero/black
44847B13	12,5x12,5	nero/black
44847B20	19x19	nero/black



Piattino fingerfood, melamina
Party plate, melamine
Fingerfood-Teller, Melamin
Petit assiette, melamine
Platillo, melamina

N

art.	dim. cm.	h.	
44844-01	9,5x9,5	1,5/3,5	bianco/white
44844B01	9,5x9,5	1,5/3,5	nero/black



Vassoio, melamina
Tray, melamine
Tablett, Melamin
Plateau, melamine
Bandeja, melamina

N

art.	dim. cm.	h.	
44844-11	53x32,5	2,5	GN1/1



Vassoio Gourmet, melamina
Tray Gourmet, melamine
Tablett GOURMET, Melamin
Plateau, melamine
Bandeja, melamina

N

art.	dim. cm.	h.
44467-29	29x5	3



Vassoio Gourmet, melamina
Tray Gourmet, melamine
Tablett GOURMET, Melamin
Plateau, melamine
Bandeja, melamina

N

art.	dim. cm.	h.	ø holes
44466-30	30,5x9,5	2,5	4



Ciotoline Gourmet, melamina
Bowl gourmet, melamine
Schälchen GOURMET, Melamin
Bol, melamine
Bols, melamina

N

art.	ø cm.	h.	ml.
44466-07	7	6	50



Ciotola, melamina
Bowl, melamine
Schale, Melamin
Bol, melamine
Bol, melamina

N

art.	dim. cm.	h.	lt.
44468-45	21x14,5	9	0,45
44468-80	26,5x16,5	12	0,80



Ciotola, melamina
Bowl, melamine
Schale, Melamin
Bol, melamine
Bol, melamina

N

art.	dim. cm.	h.
44468-26	26x13	4,5



Ciotola, melamina
Bowl, melamine
Schale, Melamin
Bol, melamine
Bol, melamina

N

art.	dim. cm.	h.	lt.
44848-26	26,5x10,5	6,5	1
44848-53	53x10,5	6,5	2



Ciotola tonda, melamina
Round bowl, melamine
Schüssel, rund, Melamin
Bol ronde, melamine
Bol redondo, melamina

art.	Ø cm.	
44846B05	5,5	nero/black
44846B09	9,0	nero/black
44846B13	13,0	nero/black
44846B15	15,0	nero/black



Ciotola tonda, melamina
Round bowl, melamine
Schüssel, rund, Melamin
Bol ronde, melamine
Bol redondo, melamina

art.	Ø cm.	
44846-05	5,5	bianco/white
44846-09	9,0	bianco/white
44846-13	13,0	bianco/white
44846-15	15,0	bianco/white



Tris zucchero, inox-melamina
Sugar stand, stainless steel-melamine
Zucker-Ständer, Edelstahl-Melamin
Tris sucrier, inox-melamine
Azucarero, inox- melamina

art.	dim. cm.	h.
44839-04	14x14	16



Portasalatini, melamina/inox
Relish dish, melamine/s-s
Salzgebäckständer, Melamin/Edelstahl
Porte-appetizers, melamine/inox
Soporte entremesas, melamina/inox

art.	dim. cm.	h.
44839-05	17x17	16



Porta stecchi, melamina
Holder for toothpicks, melamine
Behälter für Zahnstocher, Zuckerstamgen, Melamin
Porte cure-dents, melamine
Expositor para palillos, melamina

art.	dim. cm.	h.
44849-01	10x4	6,5



Ciotola 2 scomparti, melamina
Bowl for snack, melamine
Schale, 2-geteilt, Melamin
Bol 2 compartiments, melamine
Bol, 2 secciones, melamina

art.	dim. cm.	h.
44849-02	17,5x7,7	4,5



Vassoio con ciotole, melamina
Tray with melamine bowls
Tablett mit Melamin-Schalen
Plateau avec coupes melamine
Bandeja con copas melamina

art.	dim. cm.
44838-03	20x11



Vassoio con ciotole, melamina
Tray with melamine bowls
Tablett mit Melamin-Schalen
Plateau avec coupes melamine
Bandeja con copas melamina

art.	dim. cm.
44838-07	29x20



Vassoio con ciotole, melamina
Tray with melamine bowls
Tablett mit Melamin-Schalen
Plateau avec coupes melamine
Bandeja con copas melamina

art.	dim. cm.
44838-05	20x20



Cucchiaio finger-food, melamina
Party spoon, melamine
Finger-food-Löffel, Melamin
Cuiller, melamine
Cucharita, melamina

art.	dim. cm.	
44850-10	10x4,5	bianco/white
44850B10	10x4,5	nero/black



Cucchiaio finger-food, melamina
Party spoon, melamine
Finger-food-Löffel, Melamin
Cuiller, melamine
Cucharita, melamina

art.	dim. cm.	
44850-11	11x4,3	bianco/white
44850B11	10x4,5	nero/black



Cucchiaio finger-food, melamina
Party spoon, melamine
Finger-food-Löffel, Melamin
Cuiller, melamine
Cucharita, melamina

art.	dim. cm.	
44850-13	13,5x4,5	bianco/white
44850B13	13,5x4,5	nero/black



Cucchiaio finger-food, melamina
Party spoon, melamine
Finger-food-Löffel, Melamin
Cuiller, melamine
Cucharita, melamina

art.	dim. cm.	col.
44850-12	10x4,5x1	bianco/white
44850B12	10x4,5x1	nero/black
44850G12	10x4,5x1	verde/green



Fingerfood, melamina
Party spoon, melamine
Fingerfood Löffel, Melamin
Cuillère party, melamine
Cuchara party, melamina



art.	dim. cm.	h.	col.
44851-01	14,5x4,5	4,5	bianco e nero - white & black
44851-02	14,5x4,5	4,5	bianco - white
44851-03	14,5x4,5	4,5	nero - black



Cucchiaio, melamina
Spoon, melamine
Löffel, Melamin
Cuiller, melamine
Cuchara, melamina

art.	dim. cm.
44850-01	7x24



Set 6 cucchiari
Spoon, 6 pcs set
Feinkostöffel, 6er set
Set 6 cuillères
Juego de 6 cucharas

art.	dim. cm.	col.
44850-00	6x23	trasp./clear
44850W00	6x23	bianco/white
44850B00	6x23	nero/black



Pirofila ovale, melamina
Bowl oval, melamine
Schale, oval, Melamin
Plat oval, melamine
Fuente ovale, melamina

art.	dim. cm.	h.	lt.
44849-27	27x17	4,0	0,8
44849-34	34x21	4,5	1,3
44849-47	47x29	5,0	3,2



Insalatiera, melamina
Bowl, melamine
Schüssel, Melamin
Saladier, melamine
Bol, melamina

art.	ø cm.
44836-30	30



Insalatiera, melamina
Bowl, melamine
Schüssel, Melamin
Saladier, melamine
Bol, melamina

art.	ø cm.
44836G30	30



Insalatiera, melamina
Bowl, melamine
Schüssel, Melamin
Saladier, melamine
Bol, melamina

art.	ø cm.
44836B30	30



Piatto, melamina
Plate, melamine
Platte, Melamin
Plaque, melamine
Plato, melamina

art.	dim. cm.
44835-36	36x16
44835-45	45x24
44835-53	53x29



Piatto, melamina
Plate, melamine
Platte, Melamin
Plaque, melamine
Plato, melamina

art.	dim. cm.
44835G36	36x16
44835G45	45x24
44835G53	53x29



Piatto, melamina
Plate, melamine
Platte, Melamin
Plaque, melamine
Plato, melamina

art.	dim. cm.
44835B36	36x16
44835B45	45x24
44835B53	53x29

BAR HAPPY HOUR BUFFET



Piatto, melamina
Plate, melamine
Platte, Melamin
Plaque, melamine
Plato, melamina

art.	dim. cm.	h.	Col.
44834-00	34,5x8	2,5	○
44834B00	34,5x8	2,5	●
44834G00	34,5x8	2,5	●



Piatto, melamina
Plate, melamine
Platte, Melamin
Plaque, melamine
Plato, melamina

art.	dim. cm.
44836-35	34x35



Piatto, melamina
Plate, melamine
Platte, Melamin
Plaque, melamine
Plato, melamina

art.	dim. cm.
44836G35	34x35



Piatto, melamina
Plate, melamine
Platte, Melamin
Plaque, melamine
Plato, melamina

art.	dim. cm.
44836B35	34x35



Piatto, melamina
Plate, melamine
Platte, Melamin
Plaque, melamine
Plato, melamina

art.	dim. cm.	h.
44834-01	40x18,5	3,5
44834-02	52x25	4,0



Piatto, melamina
Plate, melamine
Platte, Melamin
Plaque, melamine
Plato, melamina

art.	dim. cm.	h.
44834G01	40x18,5	3,5
44834G02	52x25	4,0



Piatto, melamina
Plate, melamine
Platte, Melamin
Plaque, melamine
Plato, melamina

art.	dim. cm.	h.
44834B01	40x18,5	3,5
44834B02	52x25	4,0



Insalatiera, melamina
Bowl, melamine
Schüssel, Melamin
Saladier, melamine
Bol, melamina

art.	dim. cm.	h.	Col.
44834-03	40x18,5	10,0	○
44834G03	40x18,5	10,0	●
44834B03	40x18,5	10,0	●





Vassoio quadro, melamina
Tray, square, melamine
Tablett, quadratisch, Melamin
Plateau carré, melamine
Bandeja, cuadrada, melamina

art.	dim. cm.	h.
44886-30	30,5x30,5	4
44886-36	36x36	5



Vassoio rettangolare, melamina
Tray, rectangular, melamine
Serviertablett, rechteckig, Melamin
Plateau rectangulaire, melamine
Bandeja rectangular, melamina

art.	dim. cm.	h.
44886-38	38,5x29,5	5
44886-44	44x34,5	5



Ciotola, melamina
Bowl, melamine
Schüssel, Melamin
Bol, melamine
Bol, melamina

art.	dim. cm.	h.
44887-32	32x32	12,0
44887-36	36x36	12,5
44887-40	40x40	14,0



Ciotola, melamina
Bowl, melamine
Schüssel, Melamin
Bol, melamine
Bol, melamina

art.	ø cm.	h.
44888-32	32	16,5
44888-35	35	17,0
44888-40	40	17,5



Ciotola, melamina
Bowl, melamine
Schüssel, Melamin
Bol, melamine
Bol, melamina

art.	dim. cm.	h.
44889-32	32,5x32,5	12,0
44889-35	35x35	12,5
44889-40	40x40	14,0



TAO



Interno lucido, esterno satinato.

Mirror shiny inside, outside matt.



Ciotola, melamina
Bowl, melamine
Schüssel, Melamin
Bol, melamine
Bol, melamina

art.	dim. cm.	h.	lt.	col.
44449-32	32,5x17,5	10	1,8	○
44449B32	32,5x17,5	10	1,8	●



Ciotola, melamina
Bowl, melamine
Schüssel, Melamin
Bol, melamine
Bol, melamina

art.	dim. cm.	h.	lt.	col.
44449-30	30,5x30,5	10	3,3	○
44449B30	30,5x30,5	10	3,3	●



Ciotola, melamina
Bowl, melamine
Schüssel, Melamin
Bol, melamine
Bol, melamina

art.	dim. cm.	h.	lt.	col.
44449-33	33,5x33,5	13,5	3,8	○
44449B33	33,5x33,5	13,5	3,8	●

BAR HAPPY HOUR BUFFET



Piatto, melamina
Dish, melamine
Platte, Melamin
Plat, melamine
Bandeja, melamina

art.	dim. cm.	h.	col.
44448-18	18x10	3,5	○
44448-25	25x13,5	4,5	○
44448-30	30,5x17,5	5,0	○
44448B18	18x10	3,5	●
44448B25	25x13,5	4,5	●
44448B30	30,5x17,5	5,0	●



Ciotola, melamina
Bowl, melamine
Schüssel, Melamin
Bol, melamine
Bol, melamina

art.	dim. cm.	h.	col.
44447-10	10x13,5	6,0	○
44447-14	14,5x13,5	6,0	○
44447-18	18x16,5	6,5	○
44447B10	10x13,5	6,0	●
44447B14	14,5x13,5	6,0	●
44447B18	18x16,5	6,5	●



Ciotola, melamina
Bowl, melamine
Schüssel, Melamin
Bol, melamine
Bol, melamina

art.	dim. cm.	h.	col.
44446-10	10,5x10	6,5	○
44446-14	13,5x12,5	8,5	○
44446-18	17x16	10,5	○
44446B10	10,5x10	6,5	●
44446B14	13,5x12,5	8,5	●
44446B18	17x16	10,5	●



Vassoio, melamina
Tray, melamine
Tablett, Melamin
Plateau, melamine
Bandeja, melamina

art.	dim. cm.	h.	col.
44842-31	31x10,5	2	○
44842B31	31x10,5	2	●



Display per buffet, ABS
Buffet diplay
Büffetgestell
Etagère à buffet
Soporte platos pastre para buffet

art.	ø cm.	h.	col.
41868W00	50	21	bianco/white
41868K00	50	21	nero/black



Display per buffet, ABS
Buffet diplay
Büffetgestell
Etagère à buffet
Soporte platos pastre para buffet

art.	dim. cm.	h.	col.
41868W01	100x40	20	bianco/white
41868K01	100x40	20	nero/black



Struttura in metallo verniciato a polvere. - Metal structure powder painted.



Display per buffet, ABS
Buffet display
Büffetgestell
Etagère à buffet
Soporte platos pastre para buffet

art.	dim. cm.	h.	
41868W02	70x43	14	bianco/white
41868K02	70x43	14	nero/black

Struttura in metallo verniciato a polvere. - Metal structure powder painted.



Display per buffet, ABS
Buffet display
Büffetgestell
Etagère à buffet
Soporte platos pastre para buffet

art.	ø cm.	h.	
41868W03	56	57	bianco/white
41868K03	56	57	nero/black



Display per buffet, PS
Buffet display
Büffetgestell
Etagère à buffet
Soporte platos pastre para buffet

art.	ø cm.	h.	
41868-04	56	57	bianco/white



Display per buffet, ABS
Buffet display
Büffetgestell
Etagère à buffet
Soporte platos pastre para buffet

art.	ø cm.	h.	
41868W05	56	57	bianco/white
41868K05	56	57	nero/black

Struttura in metallo verniciato a polvere.
Metal structure powder painted.



Display con coperchio, acrilico
Rised with cover, acrylic
Büffetgestell mit Deckel, Acryl
Etagère avec couvercle, acrilique
Soporte con tapa, acrilico

art.	ø cm.	h.
41867-10	20	10
41867-20	20	20
41867-30	20	30



Display per buffet, plexiglas
Buffet display
Büffetgestell
Etagère à buffet
Soporte platos pastre para buffet

art.	dim. cm.	h.
41866-04	25x25	25-18-11-4



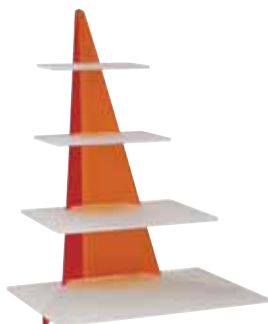

Display per buffet, plexiglas
Buffet display
Büffetgestell
Etagère à buffet
Soporte platos pastre para buffet

art.	dim. cm.	ripiani/shelves
41870-01	54x47 h. 63	47x34 - 37x25 27x17 - 23x13

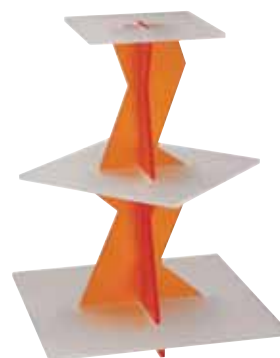

Display per buffet, plexiglas
Buffet display
Büffetgestell
Etagère à buffet
Soporte platos pastre para buffet

art.	dim. cm.	ripiani/shelves
41870-02	40x40 h. 53	40x40 - 30x30 22x22-27x17 - 23x13



Display per buffet, plexiglas
Buffet display
Büffetgestell
Etagère à buffet
Soporte platos pastre para buffet

art.	ripiani/shelves
41870-03	ø28 h.29 - 38x30 h.21 38x30 h.13 - 38x30 h.5



Display per buffet, plexiglas
Buffet display
Büffetgestell
Etagère à buffet
Soporte platos pastre para buffet

art.	ripiani/shelves
41870-04	40x27 h.29 - 40x27 h.21 40x27 h.13 - 40x27 h.5

Gambe in acciaio verniciato a polvere. - Legs powder painted.



Piramide, inox
Pyramid, stainless steel
Pyramide, Edelstahl
Pyramide, inox
Pirámide, inox

art.	dim. cm.	h.
42988-03	30x30	53

Set composto da: 1 piatto in inox rotante, 1 vassoio in melamina (51x51 cm), 1 ciotola inox (11x11 cm), 108 cucchiaini e 200 spiedini. - Set of: 1 s/s rotating plate, 1 melamine tray (51x51 cm), 1 s/s bowl (11x11 cm), 108 party spoons and 200 spits.



Cucchiaio gourmet, inox
Party spoon, stainless steel
Gourmet-Löffel, Edelstahl
Cuiller gourmet, inox
Cuchara gourmet, inox

art.	l. cm.
42988-99	13

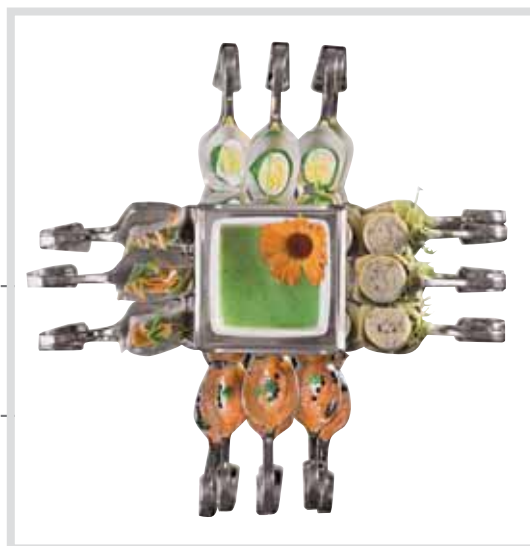



Piramide , inox
Pyramid, stainless steel
Pyramide, Edelstahl
Pyramide, inox
Pirámide, inox

art.	dim. cm.	h.
42988-02	22x22	31

Set composto da: 1 piatto in inox rotante, 1 vassoio in melamina (37x37 cm), 1 ciotola inox (11x11 cm.), 48 cucchiaini e 70 spiedini. - *Set of: 1 s/s rotating plate, 1 melamine tray (37x37 cm), 1 s/s bowl (11x11 cm), 48 party spoons and 70 spits.*



Piramide , inox
Pyramid, stainless steel
Pyramide, Edelstahl
Pyramide, inox
Pirámide, inox

art.	dim. cm.	h.
42988-01	17x17	17

Set composto da: 1 ciotola inox (11x11 cm), 24 cucchiaini e 20 spiedini. - *Set of: 1 s/s bowl (11x11 cm), 24 party spoons and 20 spits.*



Display triangolo , inox
Triangle display, stainless steel
Dreieck-Display, Edelstahl
Display triangle, inox
Display triángulo, inox

art.	dim. cm.	h.
42988-00	21,5x14	27

Set composto da: 12 cucchiaini e 20 spiedini. - *Set of: 12 party spoons and 20 spits.*



Espositore 3 piani, PMMA
Tier display, PMMA
Stufen-Display, PMMA
Présentoir 3 niveaux, PMMA
Expositor 3 alturas, PMMA

art.	dim. cm.	h.
41919-03	40x18	4
	40x20	8
	40x22	12



Alzatina per buffet
Buffet stand
Buffet-Ständer
Support à buffet
Soporte para bufet

art.	h. cm.
44840-30	8
44840-31	12
44840-32	18

Metallo con rivestimento antiscivolo nero. Lavabile in lavastoviglie. - *Metal with black anti-slide coating. Dishwasher safe.*

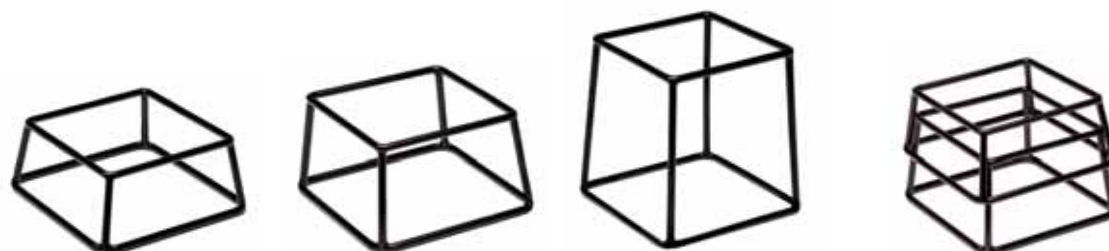

Alzatina per buffet
Buffet stand
Buffet-Ständer
Support à buffet
Soporte para bufet

art.	dim. cm.	h.
44840-08	18x18	8
44840-10	18x18	10
44840-18	18x18	18

Metallo con rivestimento antiscivolo nero. Lavabile in lavastoviglie. - *Metal with black anti-slide coating. Dishwasher safe.*



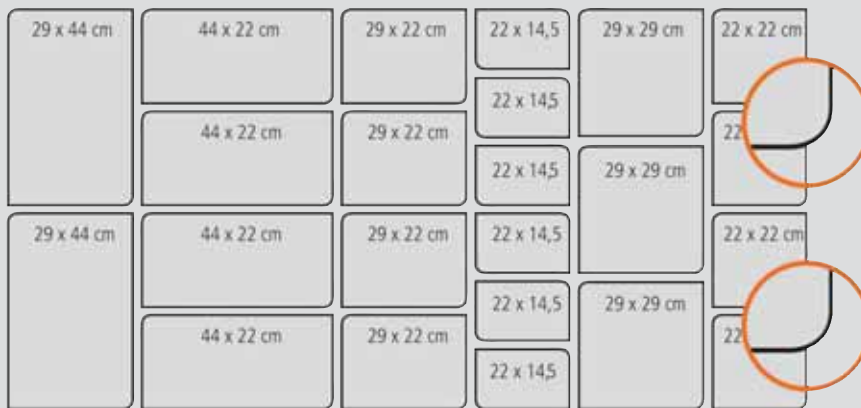

Sistema composto da 30 vassoi espositori, nei colori bianco e nero. Disponibili 5 copерchi trasparenti in SAN idonei ad ogni formato. Un flessibile sistema modulare per banchi con profondità 70-90 cm, nessuno spazio vuoto nel bancone, diverse capacità e design uniforme. Il bordo stabile permette di impilare i contenitori facilmente e velocemente, niente più graffi o contenitori inceppati.

System consist of 30 bowls and trays each in black and white color. Properly to the bowls 5 transparent SAN covers are available. Advantages: flexible modular system for counter depth 70 to 90 cm, no gap inside the counter, variable filling quantities and uniform design. The stable edge allows an easy and fast stackle and therefore no scratching or jamming of the bowls.



Bianco - White

Vassoio espositore, melamina
 Display tray, melamine
 Theke-Ausstellplatte, Melamin
 Plateau de comptoir, melamine
 Bandeja expositora, melamina

art.	dim. cm.	h.	lt.
42582-01	22x14,5	2	
42582-02	22x14,5	4	0,7
42582-03	22x14,5	6	1,0
42582-04	22x14,5	9	1,7
42582-05	22x22	4	1,0
42582-06	22x22	6	1,8
42582-07	22x22	9	3,0
42582-08	29x22	4	1,3
42582-09	29x22	6	2,1
42582-10	29x29	2	
42582-11	29x29	4	1,5
42582-12	29x29	6	3,0
42582-13	44x22	2	
42582-14	44x22	4	2,0
42582-15	44x29	2	

Nero - Black

Vassoio espositore, melamina
 Display tray, melamine
 Theke-Ausstellplatte, Melamin
 Plateau de comptoir, melamine
 Bandeja expositora, melamina

art.	dim. cm.	h.	lt.
42582B01	22x14,5	2	
42582B02	22x14,5	4	0,7
42582B03	22x14,5	6	1,0
42582B04	22x14,5	9	1,7
42582B05	22x22	4	1,0
42582B06	22x22	6	1,8
42582B07	22x22	9	3,0
42582B08	29x22	4	1,3
42582B09	29x22	6	2,1
42582B10	29x29	2	
42582B11	29x29	4	1,5
42582B12	29x29	6	3,0
42582B13	44x22	2	
42582B14	44x22	4	2,0
42582B15	44x29	2	



Cucchiaio servire, melamina
 Serving-spoon, melamine
 Servier-Löffel, Melamin
 Cuillère, melamine
 Cuchara, melamina



art.	dim. cm.	l.	
44852-01	7x6,5	26,5	bianco - white
44852-02	7x6,5	26,5	nero - black

Coperchio con spacco cucchiaio
 Lid with notch
 Deckel mit Löffelaussparung
 Couvercle avec écart pour cuillère
 Tapa con corte para cuchara

art.	dim. cm.
42582-21	22x14,5
42582-22	22x22
42582-23	29x22
42582-24	29x29
42582-25	44x22

Set 6 cucchiari
 Spoon, 6 pcs set
 Feinkostöffel, 6er set
 Set 6 cuillères
 Juego de 6 cucharas

art.	dim. cm.	col.
44850-00	6x23	trasp./clear
44850W00	6x23	bianco/white
44850B00	6x23	nero/black



Specchio acrilico, quadrato
Acrylic mirror, square
Acryl-Spiegel, quadratisch
Miroir acrylique, carré
Espejo acrílico, cuadra

art.	dim. cm.
41885-30	30x30
41885-40	40x40
41885-45	45x45
41885-50	50x50
41885-60	60x60



Specchio acrilico, ovale
Acrylic mirror, oval
Acryl-Spiegel, oval
Miroir acrylique, ovale
Espejo acrílico, oval

art.	dim. cm.
41877-45	45x30
41877-61	61x45,5
41877-81	81x61
41877-99	100x70



Specchio acrilico, rettangolare
Acrylic mirror, rectangular
Acryl-Spiegel, rechteckig
Miroir acrylique, rectangulaire
Espejo acrílico, rectangular

art.	dim. cm.
41878-45	45x30
41878-61	61x46
41878-81	81x58,5
41878-99	100x70



Specchio acrilico, ottagonò
Acrylic mirror, octagon
Acryl-Spiegel, Achteck
Miroir acrylique, octogone
Espejo acrílico, octógono

art.	ø cm.
41879-30	30
41879-40	40
41879-50	50
41879-61	61



Specchio acrilico, vírgola
Acrylic mirror, comma
Acryl-Spiegel, Komma
Miroir acrylique, virgule
Espejo acrílico, vírgula

art.	ø cm.
41875-40	40,6
41875-61	61,0



Specchio acrilico, cerchio
Acrylic mirror, circle
Acryl-Spiegel, Kreis
Miroir acrylique, cercle
Espejo acrílico, aro

art.	ø cm.
41876-30	30,5
41876-38	38,0
41876-45	45,0
41876-58	58,0



Specchio acrilico, esagonò
Acrylic mirror, hexagon
Acryl-Spiegel, Sechseck
Miroir acrylique, hexagone
Espejo acrílico, hexágono

art.	ø cm.
41880-38	38
41880-61	61



Specchio acrilico, spicchio
Acrylic mirror, segment
Acryl-Spiegel, Segment
Miroir acrylique, quartier
Espejo acrílico, segmento

art.	ø cm.
41881-30	30,5
41881-40	40,5



Specchio acrilico, cubò
Acrylic mirror, cube
Acryl-Spiegel, Würfel
Miroir acrylique, cube
Espejo acrílico, cubo

art.	dim. cm.
41882-15	15x15x15
41882-20	20x20x20
41882-25	25x25x25
41882-30	30x30x30

BAR HAPPY HOUR BUFFET



Vassoio pesce, inox
Fish tray, stainless steel
Fischplattlet, Edelstahl Rostfrei
Plat à poisson, inox
Salmonera, inox

art. dim. cm.
41655-66 66x22,5



Vassoio mezzaluna, inox
Tray, half-moon, stainless steel
Tablett, Halbmond, Edelstahl Rostfrei
Plateau demi-lune, inox
Bandeja luna, acero inox

art. dim. cm.
41421-53 53x32,5



Vassoio buffet, inox
Buffet tray, stainless steel
Büfett-Tablett, Edelstahl Rostfrei
Plateau pour buffet, inox
Bandeja para buffet, inox

art. ø cm. h.
41822-48 48 4,4



Vassoio, inox
Tray, stainless steel
Tablett, Edelstahl rostfrei
Plateau, inox
Bandeja, inox

art. ø cm.
41429-45 45



Vassoio buffet, inox
Buffet tray, stainless steel
Büfett-Tablett, Edelstahl Rostfrei
Plateau pour buffet, inox
Bandeja para buffet, inox

art. dim. cm. GN
41822-53 53x32,5 1/1



Coperchio per art. 41430-11
Cover for tray 41430-11
Haube für Art.-Nr. 41430-11
Couvercle pour plateau 41430-11
Tapa para bandeja 14130-11

art. dim. cm. h. GN
42971-52 53x32,5 9 1/1

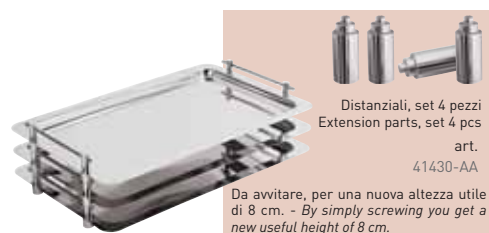

Vassoio impilabile, inox
Tray, stackable, stainless steel
Tablett, stapelbar, Edelstahl Rostfrei
Plateau empilable, inox
Bandeja apilable, acero inox

art. dim. cm. h. GN
41430-11 53x32,5 5 1/1

Maniglie cromate. Altezza utile 4 cm.
Chrome plated handles. Useful height 4 cm.

Vassoio, inox
Tray, stainless steel
Tablett, Edelstahl Rostfrei
Plateau, inox
Bandeja, inox

art. dim. cm. GN
41436-11 53x32,5 1/1
41436-12 32,5x26,5 1/2



Coperchio GN, impilabile
Cover GN, stackable
Abdeckhaube GN, stapelbar
Couvercle GN, empilable
Campana GN, apilable

art. dim. cm. h. GN
42971-32 32,5x27 9,5 1/2
42971-53 53x32,5 9,5 1/1



Vassoio bordo Deko, inox
Tray, deko-edge, stainless steel
Tablett, Dekorrand, Edelstahl Rostfrei
Plateau avec décor, inox
Bandeja, borde decorado, inox

art. dim. cm. GN
41437-11 53x32,5 1/1
41437-12 32,5x26,5 1/2



Vassoio ovale, bordo Deko, inox
Oval tray, deko-edge, stainless steel
Tablett, oval, Dekorrand, Edelstahl
Plateau oval avec décor, inox
Bandeja oval, borde decorado, inox

art. dim. cm.
41438-50 50x36
41438-60 60x41
41438-70 70x46



Vassoio, inox
Tray, stainless steel
Tablett, Edelstahl Rostfrei
Plateau, inox
Bandeja, inox

art. ø cm.
41435-58 58



Vassoio, bordo Deko, inox
Tray, deko-edge, stainless steel
Tablett, Dekorrand, 18/10 Edelstahl
Plateau avec décor, inox
Bandeja, borde decorado, inox

art.	ø cm.
41439-32	32
41439-38	38
41439-48	48



Vassoio ovale con bordo, inox
Oval meat dish with rim, stainless steel
Gebördelte Bratenplatte, oval, Edelstahl
Plat à rôti ovale, bord roulé, inox
Bandeja oval, borde vuelto, inox

art.	dim. cm.
41651-20	20x14
41651-25	25x18
41651-30	30x22
41651-35	35x22
41651-40	40x26



Vassoio ovale con bordo, inox
Oval meat dish with rim, stainless steel
Gebördelte Bratenplatte, oval, Edelstahl
Plat à rôti ovale, bord roulé, inox
Bandeja oval, borde vuelto, inox

art.	dim. cm.
41651-45	45x29
41651-50	50x35
41651-55	55x38
41651-60	60x42
41651-65	65x45



Vassoio tondo, inox
Tray, round, stainless steel
Tablett, rund, 18-10 Edelstahl
Plateau rond, inox
Bandeja redonda, inox

art.	ø cm.
66326-30	30
66326-35	35
66326-40	40
66326-60	60
66326-80	80



Piatto pesce, inox
Fish dish, stainless steel
Fischplatte, 18-10 Edelstahl
Plat à poisson, inox
Bandeja pescado, inox

art.	dim. cm.
66345-55	55x23
66345-65	65x27
66345-74	74x29



Vassoio pesce, inox
Fish tray, stainless steel
Fischplatte, Edelstahl Rostfrei
Plat à poisson, inox
Bandeja pescado, inox

art.	dim. cm.
41654-80	80x31
41654-99	100x35



Vassoio tondo, inox
Tray, round, stainless steel
Tablett, rund, 18-10 Edelstahl
Plateau rond, inox
Bandeja redonda, inox

art.	dim. cm.
66325-30	30x19
66325-35	35x22
66325-41	41x26
66325-46	46x29
66325-54	54x37
66325-85	85x58
66325-99	100x68



Vassoio, inox
Tray, stainless steel
Tablett, 18-10 Edelstahl
Plateau, inox
Bandeja, inox

art.	dim. cm.
66320-28	28x20
66320-35	35x30
66320-40	40x26
66320-50	50x38
66320-65	65x50
56020-85	85x50
56020-99	100x50



Vassoio, inox
Tray, stainless steel
Tablett, 18-10 Edelstahl
Plateau, inox
Bandeja, inox

art.	dim. cm.
66324-40	40x26
66324-50	50x38
66324-65	65x50
56024-85	85x50
56024-99	100x50

Frame BuffetSystem

by Michael Sieger / sieger design

Gli elementi che compongono il sistema sono modulari, rendendo la composizione estremamente versatile. La natura impilabile di ogni elemento consente uno stoccaggio efficiente, ottimizzando lo spazio. Le strutture porta ciotole sono impilabili sia senza che con le ciotole. Tutti gli elementi del sistema sono veloci e semplici da utilizzare, facili da impugnare sotto gli inserti (tagliere, inserto porta ciotole, vassoi, ecc.) come pure sotto la base dei moduli stessi anche quando sono impilati. Le strutture in acciaio inox ad esempio possono essere utilizzate anche senza inserti come letto per contenere ghiaccio per la presentazione di composizioni di frutti di mare o altri alimenti. Le strutture porta ciotole in acciaio inox sono costruite con una doppia parete permettendo al cibo di mantenere la temperatura più a lungo.

The system elements feature a modular construction, making them extremely versatile. The stackable nature of every element enables space-efficient storage. Bowl boxes can even be stacked with or without bowls. All the system elements are quick and simple to use, with easy to grip edges both underneath the cover panels and underneath the base modules themselves. Cool plates can be used without modular cover panels for a bed of crushed ice. Stainless steel bowl boxes are not only attractive but also insulated, allowing food to maintain its temperature for longer.



IMPILABILE
STACKABLE

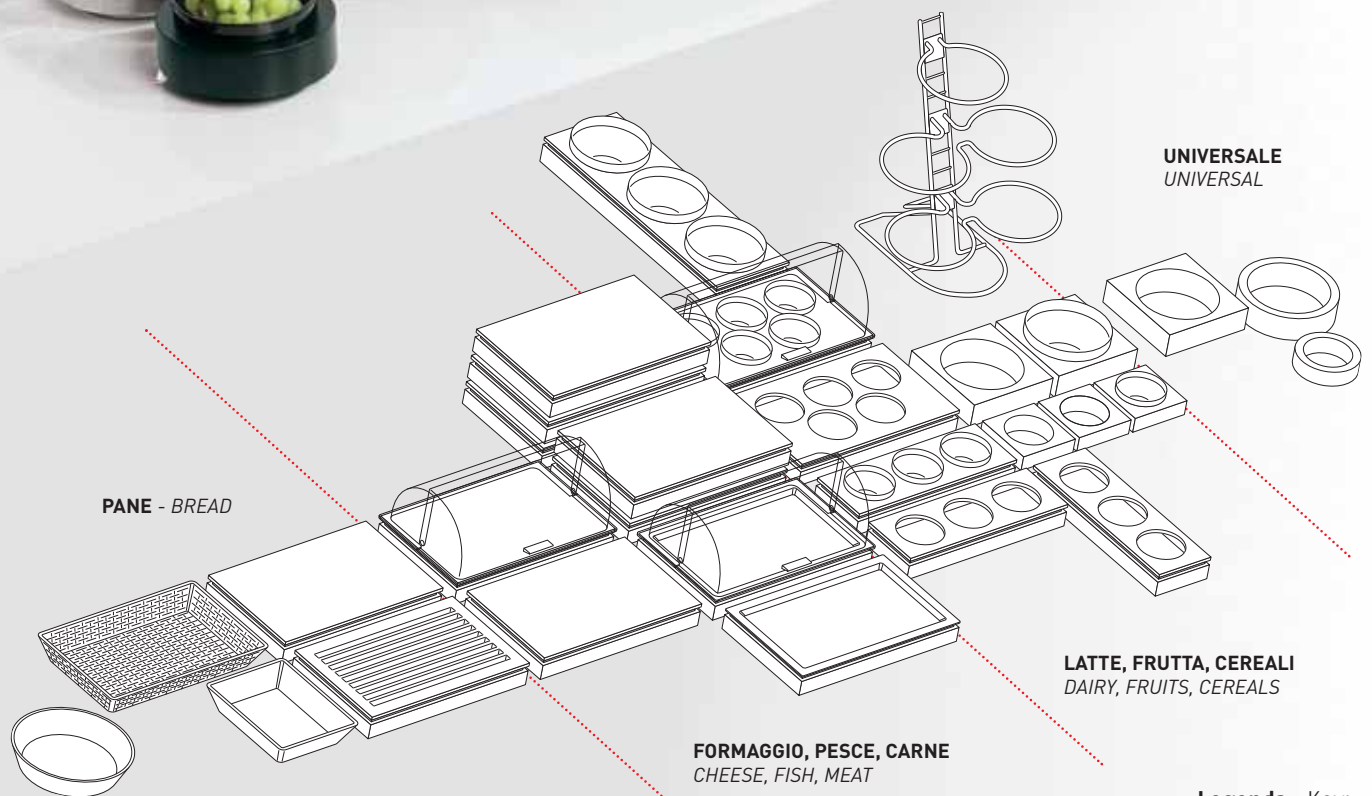

Legenda - Key:

- ACCIAIO INOX
STAINLESS STEEL
- WENGE
- ACERO
MAPLE

BAR HAPPY HOUR BUFFET FRAME BUFFETSYSTEM

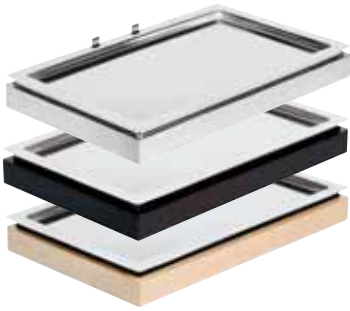

Vetrina refrigerata
Cool plate
Buffet-Vitrine, kuhlbar
Vitrine réfrigérée
Vitrina refrigerada

art.	dim. cm.	GN	col.
42450-00	53x32,5x8,5	1/1	●
42460-00	53x32,5x8,5	1/1	●
42470-00	53x32,5x8,5	1/1	●

Base GN 1/1, vassoio inox GN 1/1, eutettico. - GN 1/1 base element, GN 1/1 stainless steel platter, eutectic.



Coperchio GN roll-top, PC
GN roll-top cover
GN-Rolltophaube
Couvercle roll-top, GN
Tapa roll-top, GN

art.	GN
42452-53	1/1



Modulo per ciotole
Bowl module
Schüssel-Modul
Module pour ravieres
Módulo para fuentes

art.	fori/hotes	ø. cm.	GN	col.
42460-03	5	13,2	1/1	●
42470-03	5	13,2	1/1	●



Vassoio, inox
Tray, stainless steel
Serviertablett, Edelstahl Rostfrei
Plateau, inox
Bandeja, acero inox

art.	GN
42451-11	1/1
42451-12	1/2



Tagliere
Cutting board
Tranchierbrett
Planche à découper
Plancha para cortar

art.	dim. cm.	GN	col.
42470-06	acero/maple	1/1	●
42470-07	acero/maple	1/1	●
42460-06	PE	1/1	●



Supporto GN 1/1, legno wengè
Serving stand, wood, wenge
Gestell, Buche massiv, Wenge
Support hêtre massif, wengué
Soporte madera, wengué

N

art.	dim. cm.	h.
42460-57	57,5x27,5	22



Ciotola tonda, melamina
Round bowl, melamine
Schüssel, rund, Melamin
Bol ronde, melamine
Bol redondo, melamina

art.	ø cm.	h.	lt.
44837B05	14	6,5	0,5
44837B20	20	9,2	1,8
44837B25	23	10,0	2,5



Ciotola tonda, melamina
Round bowl, melamine
Schüssel, rund, Melamin
Bol ronde, melamine
Bol redondo, melamina

art.	ø cm.	h.	lt.
44837-05	14	6,5	0,5
44837-20	20	9,2	1,8
44837-25	23	10,0	2,5



Ciotola tonda, vetro
Round bowl, glass
Glasschüssel, rund
Bol ronde, verre
Bol redondo, vidrio

art.	ø cm.	h.	lt.
41405-AA	14	6,5	0,5
41400-AA	23	10,0	2,5



Coperchio ermetico per ciotola tonda, PC
Airtight cover for round bowl, PC
Frischhaltedeckel für Schüssel, rund, PC
Couvercle hermétique pour bol ronde, PC
Tapa hermética para bol redondo, PC

art.	ø cm.
42452-14	14
42452-23	23



Coperchio, policarbonato
Cover, polycarbonate
Deckel, PC
Couvercle, PC
Tapa, PC

art.	ø cm.
42453-23	23

N



Piastra refrigerante
Eutectic pad
Kuhlakku
Cartouche eutectique
Plancha refrigerante

art.	dim. cm.	h.
42450-AD	41x21	2,5

BAR HAPPY HOUR BUFFET



Ciotola tonda, inox
Round bowl, stainless steel
Schüssel, rund, Edelstahl Rostfrei
Bol ronde, inox
Bol redondo, inox

art.	ø cm.	h.	lt.
42961-14	14	6,5	0,5
42961-23	23	10,0	2,5



Supporto cromato, impilabile
Bowl rack, chrome-plated, stackable
Schüsselständer, verchromt, stapelbar
Support à bols, chromé, empilable
Soporte para bols, cromado, apilable

art.	ø cm.	h.
42961-12	23	12



Supporto cromato, impilabile
Bowl rack, chrome-plated, stackable
Schüsselständer, verchromt, stapelbar
Support à bols, chromé, empilable
Soporte para bols, cromado, apilable

art.	ø cm.	h.
42961-18	23	18



Box con ciotole
Box with bowls
Schüssel-Box
Boîte avec bols
Box con bols

art.	dim. cm.	h.	col.
42460-10	79,5x26,5	8,5	●
42470-10	79,5x26,5	8,5	●

Composto da elemento base, vasca polistirene e inserto portaciotole con 3 ciotole in melamina bianca ø 23 cm.
Equipped with base element, polystyrene tray, cover panel and 3 white melamine bowls ø 23 cm.



Box con ciotole
Box with bowls
Schüssel-Box
Boîte avec bols
Box con bols

art.	dim. cm.	h.	col.
42460-12	53x17,6	8,5	●
42470-12	53x17,6	8,5	●

Composto da elemento base, vasca polistirene e inserto portaciotole con 3 ciotole in melamina bianca ø 14 cm.
Equipped with base element, polystyrene tray, cover panel and 3 white melamine bowls ø 14 cm.



Box con ciotola
Box with bowl
Schüssel-Box
Boîte avec bol
Box con bol

art.	dim. cm.	h.	col.
42450-14	26,5x26,5	8,5	●
42460-14	26,5x26,5	8,5	●
42470-14	26,5x26,5	8,5	●

Composto da elemento base e ciotola in melamina bianca ø 23 cm. - *Equipped with base element and white melamine bowl ø 23 cm.*





Box con ciotola
Box with bowl
Schüssel-Box
Boîte avec bol
Box con bol

art.	dim. cm.	h.	col.
42450-16	17,4x17,4	6	●
42460-16	17,4x17,4	6	●
42470-16	17,4x17,4	6	●

Composto da elemento base e ciotola in melamina bianca ø 14 cm. - *Equipped with base element and white melamine bowl ø 14 cm.*



Box con ciotola
Box with bowl
Schüssel-Box
Boîte avec bol
Box con bol

art.	ø cm.	h.	col.
42450-18	26,6	8,5	●
42460-18	26,6	8,5	●
42470-18	26,6	8,5	●

Composto da elemento base e ciotola in melamina bianca ø 23 cm. - *Equipped with base element and white melamine bowl ø 23 cm.*



Box con ciotola
Box with bowl
Schüssel-Box
Boîte avec bol
Box con bol

art.	ø cm.	h.	col.
42450-20	17,4	6	●
42460-20	17,4	6	●
42470-20	17,4	6	●

Composto da elemento base e ciotola in melamina bianca ø 14 cm. - *Equipped with base element and white melamine bowl ø 14 cm.*



Cesto pane, PP
Bread basket
Brot-Korb
Corbeille à pain
Cesta pan



art.	ø cm.	h.
42461-35	35	20

Bordo filo cromato, fornito senza coperchio 42452-35. - *Chrome plated wire edge, roll-top 42452-35 not included.*



Coperchio roll-top, PMMA
Roll-top cover
Rolltophaube
Couvercle roll-top
Campana roll-top

art.	ø cm.
42452-35	38



Cesto pane, PP
Bread basket
Brot-Korb
Corbeille à pain
Cesta pan



art.	dim. cm.	h.	GN
42461-11	53x32,5	6,5	1/1

Fornito senza coperchio 42452-53. *Roll-top 42452-53 not included.*



Espositore buffet
Buffet stand
Buffetgestell
Présentoir à céréales
expositor de bufet



art.	dim. cm.	h.	col.
42470-53	53x21	50	●
42460-53	53x21	50	●

Ripiani - *Shelves:*
30 x 15 cm. - 40 x 17,5 cm. - 53 x 19 cm.



Portaposate, PP
Cutlery dispenser
Besteckbehälter
Bac à couverts
Dispensador de cubiertos



art.	dim. cm.	h.
42584-05	53x32,5	9

Struttura rinforzata in filo cromato. *With reinforced chromed wire structure.*



Espositore cereali
Cereal-bar
Cerealien-Buffer-Ständer
Présentoir à céréales
Expositor de cereale

N

art.	dim. cm.	h.	col.
42470-43	43x17	13,5	●
42460-43	43x17	13,5	●

Set 4 pezzi: supporto in legno con 3 vasi
lt. 2 con coperchio ermetico.
4 pcs. set: wood stand includes 3 glasses
lt. 2 with airtight cover.



Distributore di succhi
Juice dispenser
Saftdispenser
Distributeur à jus de fruit
Dispensador de zumo

N

art.	dim. cm.	h.	lt.	col.
42470-74	31x20	42	4	●
42470-76	35,5x22	50	6	●
42460-74	31x20	42	4	●
42460-76	35,5x22	50	6	●

Con 2 eutettici, coperchio e base
contenitore. - Cooling with 2 cooling
elements from the top and base.



Distributore di cereali
Cereal dispenser
Cerealienenspender
Distributeur à céréales
Dispensador de cereales

N

art.	dim. cm.	h.	lt.	col.
42470-45	21x20	55,5	4,5	●
42460-45	21x20	55,5	4,5	●



Vetrina refrigerata
Cooled buffet showcase
Büffet-Vitrine, kühlbar
Vitrine réfrigérée
Vitrina refrigerada

N

art.	dim. cm.	h.	col.
42470-63	63,5x42,5	31	●
42460-63	63,5x42,5	31	●

Composta da: base legno con coperchio
roll-top fisso, vasca plastica, GN 1/1 in
melamina, placca eutettica. - Equipment:
wood base with fixed roll-top cover, plastic
case, GN 1/1 melamine tray, cooling unit.



Portaposate
Cutlery dispenser
Besteck-Behälter
Bac à couverts
Caja portacubiertos

N

art.	dim. cm.	h.	col.
42470-64	57,5x47	12	●
42460-64	57,5x47	12	●



Ciotola refrigerata
Cool bowl
Kühlschale
Bol réfrigérée
Bol refrigerada

N

art.	dim. cm.	h.	lt.	col.
42470-26	18,5x18,5	10	0,5	●
42470-27	27,5x27,5	14	2,5	●
42460-26	18,5x18,5	10	0,5	●
42460-27	27,5x27,5	14	2,5	●

Composta da: base legno, contenitore
inox, ciotola melamina, placca eutettica.
Equipment: wood base, stainless steel
container, melamine bowl, cooling unit.



Rinfresca bottiglie
Bottle cooler
Konferenzkühler
Rafraîchisseur à bouteilles
Cubo térmico para botellas

N

art.	dim. cm.	h.	lt.	col.
42470-24	35x35	20	10	●
42460-24	35x35	20	10	●



Rinfresca bottiglie
Bottle cooler
Flaschenkühler
Rafraîchisseur à bouteilles
Cubo térmico para botellas

N

art.	ø cm.	h.	lt.
42961-31	31	20	10

Inox 18/8, doppia parete, finitura esterna
lucida, interna satinata, lavabile in
lavastoviglie. - Stainless steel 18/8, dou-
ble wall, outside mirror polished, inside
matt, dishwasher safe.



Contentitore con coperchio, porcellana
Container, porcelain
Dressingtopf, Porzellan
Conteneur, porcelaine
Contenedor, porcelana

art.	ø cm.	h.
44398-14	14	13



Alzata, cromata
Serving stand, chrome plated
Serviergestell, Metall hartverchromt
Présentoir, chromé
Soporte platos de postre, cromado

art.	ø cm.	dim.	h.
42962-26	10,5	18,5x16	26
42962-44	18	29x20	44



Contentitore a doppia parete, inox
Double-wall dressing pot, stainless steel
Doppelwandiger Dressingtopf, Edelstahl
Conteneur à double paroi, inox
Contenedor, doble pared, inox

art.	ø cm.	h.	lt.
42960-18	15	18	1,8



Alzata, cromata
Serving stand, chrome plated
Serviergestell, Metall hartverchromt
Présentoir, chromé
Soporte platos de postre, cromado

art.	ø cm.	dim.	h.
42962-04	23,5	ø34	37



Taglia pane, base legno
Bread slicer, wood base
Brotschneidergerät, Holzsockel
Coupe-pain, socle bois
Corta-pan, base madera

art.	dim. cm.	h.	kg.
49833-00	41x15	10	2,1



Taglia pane, base legno
Bread slicer, wood base
Brotschneidergerät, Holzsockel
Coupe-pain, socle bois
Corta-pan, base madera

art.	dim. cm.	h.	kg.
49831-00	23x23	21	3,5



Tagliere pane, legno
Bread cutting board, wood
Brotschneidbrett, Naturholz
Planche à découper en bois
Tabla de corte, madera

art.	dim. cm.	h.
42964-53	53x32,5	2



Distributore panini, inox/acrilico
Bread roll-dispenser, s/s-acrylic
Brötchen-Spender, Edelstahl/Acryl
Distributeur à pain, inox/acrylique
Dispensador de pan, inox/acrílico

art.	dim. cm.	h.	pcs
42963-40	32x22	40	45-50
42963-55	32x22	55	65-70



Porta Brezel, faggio
Pretzel stand, beechwood
Brezel- oder Wurstständer, Buche
Support à brezel, hêtre
Soporte para brezel, madera

art.	ø cm.	h.
42870-50	22	50



CESTI POLYRATTAN
Polyrattan baskets
PAGINA - Page: 171



Copertura igienica in acrilico
Hygienic cover, acrylic
Hygieneschutz, Acryl
Couverture d'hygiène, acrylique
Cobertura d'higiene, acrílico

art.	dim. cm.	h.
42873-65	65x39	42

Supporto cromato.
Chrome plated wire stand.



Coperchio roll-top, PMMA
Roll-top cover
Rolltopphaube
Couvercle roll-top
Campana roll-top

art.	ø cm.	h.
41429-50	48,5	23

Barretta dorata. - Gold plated knob.



Cloche, PMMA
Dome cover
Abdeckehaube
Cloche
Campana

art.	ø cm.	h.
41416-40	40	20

Pomolo dorato. - Gold plated knob.



Coperchio roll-top
Roll-top cover
Rolltopphaube
Couvercle roll-top
Campana roll-top

art.	ø cm.	h.
41447-38	38	20

Pomolo cromato. - Chrome knob.



Coperchio GN roll-top, PC
GN roll-top cover
GN-Rolltopphaube
Couvercle roll-top, GN
Tapa roll-top, GN

art.	dim. cm.	h.	GN
41415-10	53x32,5	17	1/1
41415-12	32,5x26,5	15	1/2

Barretta dorata. Termoresistente: -30+120°C.
Gold plated knob. Heat resistant: -30+120°C.



Coperchio GN roll-top, PC
GN roll-top cover
GN-Rolltopphaube
Couvercle GN roll-top
Tapa roll-top GN

art.	dim. cm.	h.	GN
41415-11	53x32,5	17	1/1

Pomolo cromato. Termoresistente: -30+120°C.
Chrome knob. Heat resistant: -30+120°C.



Coperchio GN
GN cover
GN-Kuppelhaube
Couvercle, GN
Campana GN

art.	dim. cm.	h.	GN
41418-12	54x33	20	1/1

Chiuso. - Totally closed.

BAR HAPPY HOUR BUFFET PRESENTAZIONE DISPLAY



Coperchio GN
GN cover
GN-Kuppelhaube
Couvercle, GN
Campana GN

SAN

art.	dim. cm.	h.	GN
41419-12	33x28	17	1/2



Coperchio GN, PMMA
GN cover
GN-Kuppelhaube
Couvercle, GN
Campana GN

SAN

art.	dim. cm.	h.	GN
41418-11	54x33	20	1/1



Vetrina girevole, 3 pezzi
Swivelling showplate, 3-pcs set
Käseglocke drehbar, 3-teilig
Etagère tournante, set 3 pièces
Quesera giratoria, 3 elementos

art.	ø cm.	h.
41429-03	55	30

Con apertura frontale. - One front cut.



41429-45

Vetrina, 3 pezzi
Showplate, 3-pcs set
Käseglocke, 3-teilig
Etagère, set 3 pièces
Quesera, 3 elementos

art.	ø cm.	h.
41429-04	45	24



Vetrina, set 2 pezzi
Tray, 2-pcs set
Set, 2-Tlg.
Plateau, set 2 pièces
Vitrina, 2 elementos

art.	ø cm.	h.
41447-02	38	21



Set refrigerato, 5 pezzi
Cooled tray, 5-pcs set
Thermo-Set, 5-Tlg.
Plateau réfrigéré, set 5 pièces
Vitrina refrigerada, 5 elementos

art.	ø cm.	h.
41447-05	38	24



Vetrina refrigerata, 2 piani
Cooled buffet showcase, 2 tiers
Büffet-Vitrine, kühlbar, Doppeldecker
Vitrine réfrigérée, 2 étages
Vitrina refrigerada, doble

art.	ø cm.	h.
41905-03	43,5	50



Vetrina refrigerata, 3 pezzi
Cooled buffet showcase, 3-pcs set
Büffet-Vitrine, kühlbar, 3-Tlg.
Vitrine réfrigérée, set 3 pièces
Vitrina refrigerada, 3 elementos

art.	ø cm.	h.
41905-38	43	4,5



Vetrina refrigerata, 2 piani
Cooled showcase, 2-tier
Büffet-Vitrine, kühlbar, Doppeldecker
Vitrine réfrigérée, 2 étages
Vitrina refrigerada, 2 altonas

art.	dim. cm.	h.	GN
41428-03	61x38	52	1/1

Coperchi NON inclusi. - Lids NOT included.



Vetrina refrigerata, inox
Cooled buffet showcase, stainless steel
Büffet-Vitrine, kühlbar, 18/10 Edelstahl
Vitrine réfrigérée, inox
Vitrina refrigerada, 18/10 acero

art.	dim. cm.	h.	GN
41907-56	56,5x36	8,5	1/1



Vetrina refrigerata, faggio
Cooled buffet showcase, beechwood
Büffet-Vitrine, kühlbar, Buche
Vitrine réfrigérée, hêtre
Vitrina refrigerada, madera

art.	dim. cm.	h.	GN
41906-60	59x39	4,5	1/1



Box portaggiaccio, set 3 pz
Ice-box, 3 pcs set
Eisbox, 3-teilig
Boîte à glace, 3 pièces
Cubitera, 3 elementos

art.	dim. cm.	h.	Col.
41412-11	53x32,5	12,5	Wenge

Coperchi NON inclusi. - Lids NOT included.



IMPILABILE - STACKABLE



PIEDINI ANTISCIVOLO
NON SLIP FEET



Set buffet, rettangolare
Buffet set, rectangular
Buffet-Set, eckig
Présentoir buffet, rectangulaire
Set de buffet, rectangular

N

art.	dim. cm.	h.	col.
41940-06	43,5x32,5	6	○
41940B06	43,5x32,5	6	●

4 pezzi: contenitore, vassoio, 2 eutettici.
4 pcs.: box, tray, 2 coolers.

Coperchio roll-top
Rolltop cover
Rolltop-Haube
Cloche
Campana

N **SAN**

art.	dim. cm.	h.
41941-44	44X33,5	17

Tagliere legno
Wooden board
Holzschneidebrett
Planche à découper
Tabla de madera

N

art.	dim. cm.	h.
41941-43	43,5X32,5	2



Tappeto, PP
Display tray flat
Auslage Tablett flach
Plateau de présentation
Bandeja de presentación

N

art.	dim. cm.
41941-40	40x30

Set buffet, tondo
Buffet set, round
Buffet-Set, rund
Présentoir buffet, rond
Set de buffet, redonda

N

art.	ø cm.	h.	col.
41944-06	38	6	○
41944B06	38	6	●

3 pezzi: contenitore, vassoio, 1 eutettico.
3 pcs.: box, tray, 1 cooler.

Coperchio roll-top, SAN
Rolltop cover
Rolltop-Haube
Cloche
Campana

N **SAN**

art.	ø cm.	h.
41945-38	38	20

Base non compresa. - Base not included.



Ciotola refrigerata, base inox
Cool bowl, stainless steel base
Kühlschale, Fuß aus 18-10 Edelstahl
Bol réfrigérée, base inox
Bol refrigerda, base acero

art.	ø cm.	h.	lt.
41448-06	14	9,0	0,6
41448-10	14	11,5	1,0

Ciotola refrigerata, base inox
Cool bowl, stainless steel base
Kühlschale, Fuß aus 18-10 Edelstahl
Bol réfrigérée, base inox
Bol refrigerda, base acero

art.	ø cm.	h.	lt.
41448-25	22	14	2,5
41448-40	22	18	4,0

Porta yogurt refrigerato, inox
Cooled yogurt dispenser, stainless steel
Yogurt-Ständer, kühlbar, Edelstahl
Rafraichissoir à yogurt, inox
Enfriador para yogurt, acero inox

art.	ø cm.
58402-33	33
58402-40	40



Supporto cromato
Serving stand, chrome plated
Serviergestell, hartverchromt
Présentoir, acier chromé
Soporte platos, acero cromado

art.	dim. cm.	h.
44840-06	39x39	17



Supporto cromato
Serving stand, chrome plated
Serviergestell, hartverchromt
Présentoir, acier chromé
Soporte platos, acero cromado

art.	dim. cm.	h.
44840-07	55,5x19	15,5



Set 6 cucchiari
Spoon, 6 pcs set
Feinkostöffel, 6er set
Set 6 cuillères
Juego de 6 cucharas

art.	dim. cm.	col.
44850-00	6x23	trasp./clear
44850W00	6x23	bianco/white
44850B00	6x23	nero/black

SAN



Ciotola, melamina
Bowl, melamine
Schüssel, Melamin
Bol, melamine
Bol, melamina

art.	dim. cm.	h.
44884-12	12,5x12,5	6,0
44884-19	19x19	9,5
44884-25	25x25	12,0



Ciotola, melamina
Bowl, melamine
Schüssel, Melamin
Bol, melamine
Bol, melamina

art.	dim. cm.	h.
44884B12	12,5x12,5	6,0
44884B19	19x19	9,5
44884B25	25x25	12,0



Coperchio
Cover
Abdeckhaube
Couvercle
Campana

art.	dim. cm.	col.
44885-19	19x19	trasp./clear
44885-25	25x25	trasp./clear

SAN



Alzata, cromata
Buffet stand, chrome plated
Buffet-Gestell, Metall hartverchromt
Présentoir, chromé
Soporte, cromado

art.	ø cm.	h.
41442-01	24	17

1 ciotola in vetro ø 23 cm, 2,5 lt e 1 coperchio. - 1 glass bowl ø 23 cm, 2,5 lt and 1 hinged cover.



Alzata, 3 piani, cromata
Buffet stand, 3 tiers, chrome plated
Buffet-Gestell, 3-stöckig, Metall hartverchromt
Présentoir, 3 étages, chromé
Soporte 3 pisos, cromado

art.	dim. cm.	h.
41442-03	61x24	35

3 ciotole in vetro ø 23 cm, 2,5 lt e 3 coperchi. - 3 glass bowls ø 23 cm, 2,5 lt and 3 hinged covers.



Espositore cromato
Buffet rack, chrome-plated
Buffet-Ständer, verchromt
Etagère chromée
Dispensador cromado

art.	dim. cm.	h.	ø
41442-14	30x30	14	13,5

BAR HAPPY HOUR BUFFET



Espositore cromato
Buffet rack, chrome-plated
Büffet-Ständer, verchromt
Etagère chromée
Dispensador cromado

art.	dim. cm.	h.	Ø
41442-23	50x50	18	23



Portaciotole, cromato
Bowl holder, chromed
Schalenhalter, Metall hartverchromt
Etagère à bols, chromée
Soporte para bols, cromado

art.	Ø cm.	h.
41427-40	18	25,5

Per 36 ciotoline Ø 7cm. - For 36 bowls Ø 7cm.



Portaciotole, cromato
Bowl holder, chromed
Schalenhalter, Metall hartverchromt
Etagère à bols, chromée
Soporte para bols, cromado

art.	Ø cm.	h.
41427-18	17,5	36,5

Per 15 ciotole Ø 14 cm.
For 15 bowls Ø 14cm.



Ciotole vetro
Glass bowls
Glasschalen
Bols en verre
Bols de vidrio

art.	Ø cm.	lt.
41425-AA	7	
41405-AA	14	0,5
41400-AA	23	2,5



Coperchio, acrilico
Cover, acrylic
Deckel, acryl
Couvercle, acrylique
Tapa, acrílico

art.	Ø cm.
41405-AB	14
41400-AB	23



Espositore 3 piani, cromato
Buffet ladder 3-tier, chrome plated
Büffet-Leiter 3-stufig, verchromt
Escalier 3 étages, chromé
Escalera 3 alturas, cromada

art.	dim. cm.	h.	Ø
41912-03	30x30	48	13,5



Espositore 4 piani, cromato
Buffet ladder 4-tier, chrome plated
Büffet-Leiter 4-stufig, verchromt
Escalier 4 étages, chromé
Escalera 4 alturas, cromada

art.	dim. cm.	h.	Ø
41912-04	30x30	48	13,5



Espositore 3 piani, cromato
Buffet ladder 3-tier, chrome plated
Büffet-Leiter 3-stufig, verchromt
Escalier 3 étages, chromé
Escalera 3 alturas, cromada

art.	dim. cm.	h.	Ø
41913-03	39x31	66	23



Espositore 4 piani, cromato
Buffet ladder 4-tier, chrome plated
Büffet-Leiter 4-stufig, verchromt
Escalier 4 étages, chromé
Escalera 4 alturas, cromada

art.	dim. cm.	h.	Ø
41913-04	39x31	66	23



Supporto cromato
Serving stand, chrome plated
Serviergestell, hartverchromt
Présentoir, acier chromé
Soporte, acero cromado



art.	ø cm.	h.	bowls
44840-25	35	46	4xø14

Senza ciotole - *Without bowls.*
Ciotole - *Bowls*: 44837-05, 44837B05.
vedi pag. - see page 361



Supporto cromato
Serving stand, chrome plated
Serviergestell, hartverchromt
Présentoir, acier chromé
Soporte, acero cromado



art.	ø cm.	h.	bowls
44840-26	48	46	4xø20

Senza ciotole/ceste - *Without bowls/baskets.*
Ciotole - *Bowls*: 44837-20, 44837B20.
Ceste - *Baskets*: 42990-20, 42990M20, 42290N20
vedi pag. - see page 361
vedi pag. - see page 176



Supporto cromato
Serving stand, chrome plated
Serviergestell, hartverchromt
Présentoir, acier chromé
Soporte, acero cromado



art.	ø cm.	h.	bowls
44840-27	22	59	12xø6
44840-28	22	33	6xø6

Forniti senza vetri - *Delivered without glasses.*
Vasetti idonei - Suitable glasses:
41589C08, 41589C16, 41589-08, 41589-14, 41589-16.
vedi pag. - see page 276



Espositore per cereali, plexiglas
Cereal-bar, plexiglas
Cerealien-Bar, Plexiglas
Présentoir à céréales, plexiglas
Expositor de cereales, plexiglas

art.	dim. cm.	h.	lt.
41918-03	38x15,5	4	3x1,5
41918-04	38x15,5	8	3x1,5



Espositore per cereali, plexiglas
Cereal-bar, plexiglas
Cerealien-Bar, Plexiglas
Présentoir à céréales, plexiglas
Expositor de cereales, plexiglas

art.	dim. cm.	h.	lt.
41918-01	26x15,5	4	2x1,5

Espositore per cereali, plexiglas
Cereal-bar, plexiglas
Cerealien-Bar, Plexiglas
Présentoir à céréales, plexiglas
Expositor de cereales, plexiglas

art.	dim. cm.	h.	lt.
41918-02	26x15,5	8	2x1,5



Caraffa cereali, PC
Cereal pitcher, PC
Cerealien-Karaffe, PC
Carafe à céréales, PC
Giarra de cereales, PC

art.	ø cm.	h.	lt.
41918-05	10	28	1,5



Caraffa con coperchio, PC
Fruit-juice pitcher with cover
Saftkanne mit Deckel
Carafe avec couvercle
Jarra de zumo con tapa

art.	ø cm.	h.	lt.
44993-01	11	30	1,6
44993-02	11	30	1,6



Caraffa con coperchio, PC
Fruit-juice pitcher with cover
Saftkanne mit Deckel
Carafe avec couvercle
Jarra de zumo con tapa

art.	ø cm.	h.	lt.
44993-03	11	30	1,6
44993-04	11	30	1,6

BAR HAPPY HOUR BUFFET



P



Caraffa, MS
Juice pitcher, MS
Saftkanne, MS
Carafe à jus de fruits, MS
Jarra zumo, MS

Caraffa, MS
Juice pitcher, MS
Saftkanne, Kunststoff, MS
Carafe à jus de fruits, MS
Jarra de zumo, MS

Caraffa, MS
Juice pitcher, MS
Saftkanne, MS
Carafe à jus de fruits, MS
Jarra zumo, MS

art.	Ø cm.	h.	lt.
44992-03	26	29	3

art.	Ø cm.	h.	lt.
44994-00	14	29	2,5

art.	Ø cm.	h.	lt.
44992-02	16,5	26	2

Antiurto e antigraffio, non idoneo al lavaggio in lavastoviglie, resistente fino a +85°C. - *Schokproof, scratchproof, no dishwasher safe, heat resistant up to +85°.*



PP



N

Caraffa acrilico
Juice pitcher, acrylic
Saftkanne, Acryl
Carafe à jus de fruits, acrylique
Jarra zumo, acrílico

Caraffa, policarbonato
Juice pitcher, PC
Saftkanne, PC
Carafe à jus de fruits, PC
Jarra zumo, PC

Caraffa con coperchio, policarbonato
Juice pitcher with lid, PC
Saftkanne mit Deckel, PC
Carafe à jus de fruits avec couvercle, PC
Jarra zumo con tapa, PC

art.	dim. cm.	h.	lt.
44995-25	23x13	27	2,5

Con tubo ghiaccio e camera frutta. Contenuto con tubo 2,2 lt.
With ice-tube and fruit chamber, content with tube 2,2 liters.

art.	lt.
44871-30	1,0
44871-31	coperchio / lid

Impilabile. - *Stackable.*

art.	lt.
44999-25	1,25



N



N



Caraffa vetro
Juice pitcher, glass
Glas-Saftkanne
Carafe à jus de fruits, verre
Jarra zumo, vidrio

Caraffa vetro
Juice pitcher, glass
Glas-Saftkanne
Carafe à jus de fruits, verre
Jarra zumo, vidrio

Caraffa vetro
Juice pitcher, glass
Glas-Saftkanne
Carafe à jus de fruits, verre
Jarra zumo, vidrio

art.	Ø cm.	h.	lt.
44995-15	9,5	27	1,5

Coperchio inox. - *Stainless steel lid.*
-10°C/+110°C

art.	Ø cm.	h.	lt.
44995-14	16	27	1,4

Tappo apre e chiude automaticamente. Piede cromato con eutettico, mantiene le bevande refrigerate fino a 4 ore. - *Spout opens and closes automatically. Chromed foot with cooler, keep drinks chilled up to 4 hours.*

art.	Ø cm.	h.	lt.
44995-10	9,5	29	1

Tappo versatore apre e chiude automaticamente. - *Spout opens and closes automatically while serving.*



Multi-distributore, inox
Multi rack, stainless steel
Multi Rack, 18-10 Edelstahl
Distributeur, inox
Dispensador, acero 18/10

art.	dim. cm.	h.	lt.
41911-04	19x24	53	4x1
41911-03	19x24	41	3x1
41911-02	19x24	28	2x1



Sistema professionale Multi Rack. Varianti ottenibili assemblando canestri e scivoli dalla finitura smerigliata sulle varie strutture in acciaio satinato. Capacità dei canestri 1 litro circa. Lavabili in lavastoviglie. Un pratico organizer per snack bar, caffetterie, self-service, buffet.
Multi Rack professional system. Easy to assemble in different combinations, plastic bowls and slides frosted look on satin finish stainless steel frames. Bowl capacity 1 liter ca. and dishwasher proof. A nice and practical organizer for snack bar, café canteen, buffet.



Multi-distributore, legno
Multi rack, wood
Multi Rack, Holz
Distributeur, bois
Dispensador, madera

art.	dim. cm.	h.
41908-00	26x18	43



Multi-distributore, acrilico
Multi rack, acrylic
Multi Rack, acryl
Distributeur, acrylique
Dispensador, acrílico

art.	dim. cm.	h.
41908-01	26x18	43



Espositore girevole per müsli, inox
Swivelling cereal stand, stainless steel
Büffet-Etagère, drehbar, Edelstahl
Etagère tournante à céréales, inox
Dispensador giratorio de cereales, inox

art.	ø cm.	h.	ø
41400-60	48	60	23



Espositore girevole per müsli, faggio
Swivelling cereal stand, beech wood
Büffet-Etagère, drehbar, Buche
Etagère tournante à céréales, hêtre
Dispensador giratorio de cereales, madera

art.	ø cm.	h.	ø
41401-60	48	60	23



Distributore di cereali, inox
Cereal dispenser, stainless steel
Müslispender, Edelstahl Rostfrei
Distributeur à céréales, inox
Dispensador de cereales, inox

art.	ø cm.	h.	lt.
41909-13	38	54	3x4,5



Distributore di cereali, inox
Cereal dispenser, stainless steel
Müslispender, Edelstahl Rostfrei
Distributeur à céréales, inox
Dispensador de cereales, inox

art.	dim. cm.	h.	lt.
41909-08	35x26,5	68	8



Distributore di cereali
Cereal dispenser
Müslispender
Distributeur à céréales
Dispensador de cereales

art.	dim. cm.	h.	lt.
41810-04	22x17,5	52	4,5



Distributore di cereali DUO
DUO cereal dispenser
Müslispender DUO
Distributeur à céréales DUO
Dispensador de cereales, doble

art.	dim. cm.	h.	lt.
41810-09	22x35	52	4,5x2



Distributore di succhi, inox
Juice dispenser, stainless steel
Saftdispenser, Edelstahl Rostfrei
Distributeur à jus, inox
Dispensador zumos, acero inox

art.	dim. cm.	h.	lt.
58353-17	22x35	56	7



Distributore di succhi, inox
Juice dispenser, stainless steel
Saftdispenser, Edelstahl Rostfrei
Distributeur à jus, inox
Dispensador zumos, acero inox

art.	dim. cm.	h.	lt.
41902-04	21x32	43	4
41902-06	23x35	52	6



Distributore di succhi, inox/faggio
Juice dispenser, s/s-beech wood
Saftdispenser, Edelstahl/Buche
Distributeur à jus, inox/hêtre
Dispensador zumos, inox/madera

art.	dim. cm.	h.	lt.
41907-04	21x31	44	4
41907-06	23x35	52	6



Distributore di latte, inox
Milk dispenser, stainless steel
Milchkanne, Edelstahl Rostfrei
Distributeur à lait, inox
Dispensador de leche, inox

art.	dim. cm.	h.	lt.
41910-03	21x32	39	3
41910-05	23x35	52	5



Distributore di latte, inox/faggio
Milk dispenser, s/s-beech wood
Milchkanne, Edelstahl/Buche
Distributeur à lait, inox/hêtre
Dispensador de leche, inox/madera

art.	dim. cm.	h.	lt.
41920-03	21x32	39	3
41920-05	23x35	52	5



Distributore di succhi DUO, inox
DUO juice dispenser, stainless steel
Saftdispenser DUO, Edelstahl
Distributeur à jus DUO, inox
Dispensador de zumo, doble, inox

art.	dim. cm.	h.	lt.
41917-02	42x35	52	2x6



Distributore di succhi DUO, inox/faggio
DUO juice dispenser, s/s - beech wood
Saftdispenser DUO, Edelstahl/Buche
Distributeur à jus DUO, inox/hêtre
Dispensador de zumo, inox /madera

art.	dim. cm.	h.	lt.
41907-02	42x35	52	2x6



Distributore di succhi, inox
Juice dispenser, stainless steel
Saftdispenser, Edelstahl Rostfrei
Distributeur à jus, inox
Dispensador de zumo, inox

art.	dim. cm.	h.	lt.
41901-08	36x26	55	8



Distributore di succhi DUO, inox
DUO Juice dispenser, stainless steel
Saftdispenser DUO, Edelstahl Rostfrei
Distributeur à jus DUO, inox
Dispensador de zumo, doble, inox

art.	dim. cm.	h.	lt.
41901-16	36x52	55	8x2



Distributore di latte, base legno
Milk dispenser, beech-wood base
Milchkanne, Buchenholz-Fuß
Distributeur à lait, pied en bois
Dispensador de leche, madera

art.	dim. cm.	h.	lt.
41900-04	23x32	42	4
41900-10	27x38,5	45	10



Distributore termico, inox
Insulated dispenser, stainless steel
Iso-Dispenser, Edelstahl Rostfrei
Distributeur isothermique, inox
Dispensador térmico, inox

art.	ø cm.	h.	lt.
41904-10	24	42	9,5



Caraffa termica, inox
Air pot, stainless steel
Thermopumpkanne, Edelstahl Rostfrei
Pot à air isothermique, inox
Jarra térmica, inox

art.	lt.
42406-35	3,5
42406-40	4,0



Caraffa termica, inox
Air pot, stainless steel
Thermopumpkanne, Edelstahl Rostfrei
Pot à air isothermique, inox
Jarra térmica, inox

art.	lt.
42400-19	1,9
42400-25	2,5
42400-30	3,0



Alzata Royale, inox
Fruit stand, stainless steel
Obstständer, Edelstahl Rostfrei
Etagère Royale, inox
Expositor de frutas, inox

art.	ø cm.	h.
41820-03	24-33-42	50



Ciotola porta frutta, inox
Fruit bowl, stainless steel
Obstschale, Edelstahl Rostfrei
Bol à fruits, inox
Bol de frutas, inox

art.	ø cm.	h.
41449-27	27,5	32



Ciotola porta frutta, inox
Fruit bowl, stainless steel
Obstschale, Edelstahl Rostfrei
Bol à fruits, inox
Bol de frutas, inox

art.	ø cm.	h.
41449-32	32	53



Alzata frutta, 3 piani, inox
Fruit stand, 3 tiers, stainless steel
Obstständer, 3-stöckig, Edelstahl
Etagère à fruits, 3 étages, inox
Frutero 3 pisos, inox

art.	ø cm.	h.
42940-03	32-38-48	50

Ciotola inox . Struttura in filo cromato. - Stainless steel pan, chrome plated wire.



Alzata torta, melamina
 Cake stand, melamine
 Tortenplatte, Melamin
 Gueridon pâtissier, melamine
 Pedestal para tartas, melamina

art.	Ø cm.	h.
44873-08	31	8
44873-16	31	16



Alzata torta, inox 18-8
 Cake stand, stainless steel
 Tortenplatte, Edelstahl Rostfrei
 Gueridon pâtissier, inox
 Pedestal para tartas, inox

art.	Ø cm.	h.
41537-34	34,5	13,5

Ciotola, melamina
 Bowl, melamine
 Schüssel, Melamin
 Bol, melamine
 Bol, melamina



Alzata torta, melamina
 Cake stand, melamine
 Tortenplatte, Melamin
 Gueridon pâtissier, melamine
 Pedestal para tartas, melamina

art.	dim. cm.	h.
44874-08	31x31	8
44874-16	31x31	16



Campana, PS
 Dome cover, PS
 Frischhalte-Haube, PS
 Cloche, PS
 Cubierta, PS

art.	Ø cm.	h.
41537-33	33	12,5



Alzata per torte, alluminio
 Wedding cake stand, aluminum
 Hochzeitstortenständer, Aluminium
 Support pour tourte de mariage, alu
 Pedestal para tartas, aluminio

art.	Ø cm.
47100-03	20-26-32
47100-04	20-26-32-40
47100-05	20-26-32-40-45
47100-06	20-26-32-40-45-50



Alzata per torte, alluminio
 Wedding cake stand, aluminum
 Hochzeitstortenständer, Aluminium
 Support pour tourte de mariage, alu
 Pedestal para tartas, aluminio

art.	Ø cm.
47100-07	16-20-26-32-40-45-50
47100-08	16-20-26-32-40-45-50-55
47100-09	16-20-26-32-40-45-50-55-60



Alzata torta, 5 piani, inox
 Cake stand, 5 tiers, stainless steel
 Kuchenständer, 5-stöckig, Edelstahl
 Présentoir pâtissier, 5 étages, inox
 Pedestal para tartas, 5 alturas, inox

art.	Ø cm.	h.
41533-05	11-22-24-30-36	64

Distanziali h. 16,5 cm. - Distance between tiers 16,5 cm.



Alzata torta, inox
Cake stand, stainless steel
Tortenplatte, Edelstahl Rostfrei
Gueridon pâtissier, inox
Pedestal para tartas, inox

art.	ø cm.	h.
41538-20	20	5
41538-24	24	5
41538-30	30	5
41538-36	36	5



Alzata torta, inox
Cake stand, stainless steel
Tortenplatte, Edelstahl Rostfrei
Gueridon pâtissier, inox
Pedestal para tartas, inox

art.	ø cm.	h.
47099-22	22	10
47099-30	30	10
47099-36	36	10



Coppa punch, inox
Punch bowl, stainless steel
Punchbowle, Edelstahl Rostfrei
Rafraîchisseur, inox
Ponchero, acero inox

art.	ø cm.	lt.
11956-37	37	9,5
11956-42	42	15,0

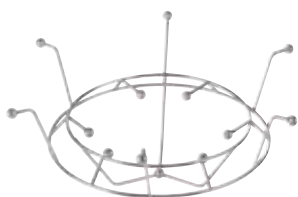

Anello portabottiglie/bicchieri, inox
Bottle/glass ring insert, stainless steel
Flaschen-/Gläser-Einsatzring, Edelstahl
Anneau porte verres et bouteilles, inox
Anillo para botellas y vasos, inox

art.	ø cm.
11956-AA	37
11956-AB	42



Coppa punch, policarbonato
Punch bowl, PC
Punchbowle, PC
Rafraîchisseur, PC
Ponchero, PC

art.	ø cm.	lt.
41541-44	44	15

Piede inox. - Stainless steel bottom ring.



Secchio champagne, acrilico
Wine party tub, acrylic
Flaschenkühler-Bowle, acryl
Rafraîchisseur à bouteilles, acrylique
Ponchero, acrílico

art.	dim cm.	h.
44946-04	40x28	23



Secchio portabottiglie, acrilico
Big party tub, acrylic
Flaschenkühler-Bowle, acryl
Rafraîchisseur à bouteilles, acrylique
Ponchero, acrílico

art.	dim. cm.	h.	
44946-05	35x35	20	trasp./clear
44946B05	35x35	20	nero/black



Colonna luminosa per piatto frutti di mare **N**
Lightning column for oyster plate
Lichtsäule für Austernplatte
Socle lumineux pour plat à huîtres
Columna luminosa para fuente de mariscos

art.	ø cm.	h.
42979-00	30	21

Composto da un piatto inox ø30 cm. e colonna in PMMA, scatola luci-LED e telecomando. Piatto frutti di mare non incluso. - Stainless steel base plate ø30 cm., PMMA column, LED-light box and remote control. Oyster plate not included.



Piatto frutti di mare, inox **N**
Oyster plate, stainless steel
Austernplatte, Edelstahl Rostfrei
Plat à huîtres, inox
Fuente de mariscos, inox

art.	ø cm.	h.
42979-36	36	4,5
42979-45	45	5,5

Sotto il piatto è fissato un elemento di centraggio che lo mantiene ancorato alla colonna luminosa. - The plate has a centering element which keeps it anchored to the column.



Fontana cocktails, inox
Cocktail fountain, stainless steel
Cocktails-Laufbrunnen, Edelstahl
Fontaine à cocktails, inox
Fuente cocktail, inox

art.	ø cm.	h.	lt.
42981-73	42	56	15

Illuminazione della colonna, 12V. Prodotto NON consigliato per liquidi gasati o champagne. - *With light inside the column, 12V. NOT recommend for use with fizzy drinks or champagne.*



Cascata champagne, inox
Champagne Waterfall, stainless steel
Sekt Wasserfall,Edelstahl Rostfrei
Cascade à champagne, inox
Cascada champaña, inox

art.	ø cm.	h.
42980-01	45	5,5

Fornita in cassa di legno, con 4 dischi in PMMA, 1 tubo diffusore bianco, illuminazione a LED a cicli di più colori. - *Delivered in wood case, with 4 PMMA discs, 1 white diffusing tube, lighting with LED in alternating colors.*



Fontana cocktails, inox
Cocktail fountain, stainless steel
Cocktails-Laufbrunnen, Edelstahl
Fontaine à cocktails, inox
Fuente cocktail, inox

art.	ø cm.	h.	lt.
42981-32	52	83	32

Illuminazione fissa o variabile, regolazione intensità, velocità cambio colore, ecc., selezionabili tramite telecomando. Colonna in PMMA. Portata: 1000 litri/h. Non adatta per liquidi gassosi, non utilizzare con liquidi a temperatura superiore a 35°. - *Lighting fixed or alternate colors, brightness control, color change speed, etc., by remote control. Column in PMMA. Capacity: 1000 Lt/h. Not suitable for sparkling drinks, do not use with liquids at a temperature higher than 35 °.*



Cascata champagne, inox
Champagne Waterfall, stainless steel
Sekt Wasserfall,Edelstahl Rostfrei
Cascade à champagne, inox
Cascada champaña, inox

art.	ø cm.	h.
42980-02	45	5,5

Fornita in cassa di legno, con 4 dischi in PMMA, 1 tubo diffusore bianco, illuminazione a LED a cicli di più colori. - *Delivered in wood case, with 4 PMMA discs, 1 white diffusing tube, lighting with LED in alternating colors.*

ALZATE TORTA - CAKE STANDS



Gradus



Base



Cinque piani utili, Ø piatti cm. 28, 26, 24 e nr. 2 da 22 cm.
Five levels, Ø of plates cm. 28, 26, 24 and no. 2 of 22 cm.

art.	dim. cm.	h.	porzioni/portions
47910-10	88x30	39	45/55

art.	Ø cm.	h.	porzioni/portions
47910-AA	85	23	85/95



Velocipede - Bicycle



Tre piani utili: 2 Ø 22 cm, 1 Ø 26 cm. Può essere utilizzata con la base 47910-AA - Fino a 110/120 porzioni. - Three levels: 2 Ø 22 cm, 1 Ø 26 cm. Can be used with base 47910-AA - Up to 110/120 portions.

art.	dim. cm.	h.	porzioni/portions
47910-02	90x35	60	25/30

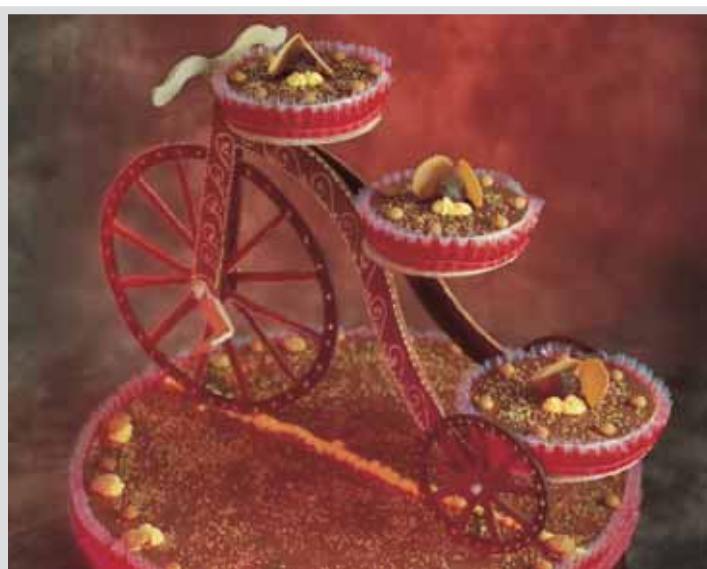

Milano



Cinque piani utili: 4 Ø 20 cm, 1 Ø 25 cm.
Five levels: 4 Ø 20 cm, 1 Ø 25 cm.

art.	Ø cm.	h.	porzioni/portions
47910-17	62	38	30/35



Memphis



Quattro piani utili Ø 30 cm.
Four levels Ø 30 cm.

art.	Ø cm.	h.	porzioni/portions
47910-16	70	50	50/60

BAR HAPPY HOUR BUFFET



Lotus

Undici piani utili: 5 cm 32x16, 5 cm 20x10, 1 ø cm 18.
 Eleven levels: 5 cm 32x16, 5 cm 20x10, 1 ø cm 18.

art.	ø cm.	h.	porzioni/portions
47910-11	70	25	55/60



Conchiglia - Shell

La base può essere riempita di ghiaccio. Può essere utilizzata con la base 47910-AA. Fino a 120/140 porzioni. - The base can be filled with ice to keep food fresh. Can be used with base 47910-AA. - Up to 120/140 portions.

art.	ø cm.	h.	porzioni/portions
47910-03	60	70	35/45



Flora

Dodici piani utili: 4 ø cm 32, 7 ø cm 26, 1 ø cm 32.
 Twelve levels: 4 ø cm 32, 7 ø cm 26, 1 ø cm 32.

art.	ø cm.	h.	porzioni/portions
47910-15	110	130	145/155



Romantica

Dodici piani utili: 5 ø 26 cm, 5 ø 20 cm, 1 ø 34 cm.
 Twelve levels: 5 ø 26 cm, 5 ø 20 cm, 1 ø 34 cm.

art.	ø cm.	h.	porzioni/portions
47910-01	80	70	100/110



Colonna quadra - Square column

Quattro piani utili: cm 40x40, cm 35x35, cm 30x30, cm 25x25.
 Four levels: cm 40x40, cm 35x35, cm 30x30, cm 25x25.

art.	dim. cm.	h.	porzioni/portions
47910-07	40x40	80	80/85



Colonna tonda - Round column

Quattro piani utili: cm ø 39, cm ø 34, cm ø 29, cm ø 24.
 Four levels: cm ø 39, cm ø 34, cm ø 29, cm ø 24.

art.	ø cm.	h.	porzioni/portions
47910-08	39	80	40/50

SCULTURE GHIACCIO - ICE SCULPTURES

Stampi riutilizzabili per sculture di ghiaccio in speciale materiale plastico con l'aggiunta di uno strato esterno di resina arancione che conferisce ai due gusci più elasticità e resistenza durante l'espansione del ghiaccio. La guarnizione siliconica posizionata all'interno del guscio ed il sistema di fissaggio composto da un kit di volantini non permettono la fuoriuscita dell'acqua. Si consiglia di riempire lo stampo con acqua e piccoli pezzetti di ghiaccio. Per ottenere una scultura più trasparente è consigliabile prolungare il processo di congelazione. La temperatura ottimale è tra i -10°C e -20°C . Prima di aprire lo stampo lasciare a temperatura ambiente per 10 minuti. Aprire lo stampo quando si trova in posizione orizzontale. Estrarre la scultura dallo stampo, rimuovere il ghiaccio in eccesso con l'aiuto di un cutter, pulire e lucidare la scultura con un cannetto e/o un panno.

Reusable molds for ice sculptures made of special plastic with an additional external orange coating of resin which makes the two shells more elastic and more resistant against ice expansion. The silicone trimming inside the shell and the fixing screws do not let the water come out. We suggest to fill the mold with water and small ice cubes. In order to obtain a more transparent sculpture we suggest to prolong the freezing process as much as possible. Recommended temperature between -10°C and -20°C . Before opening the mold leave it at room temperature for 10 minutes then open the mold horizontally on a table and extract the sculpture. Remove exiding ice with a cutter and polish the sculpture with a mini torch and/or a cloth.



Delfino - Dolphin
Delphin - Dauphin - Delfin

art.	cm. scultura/sculpture	cm. stampo/mold	kg.
47880R03	37x25 h. 58	65x25 h. 69	7



Conchiglia - Shell
Muschel - Coquille - Concha

art.	cm. scultura/sculpture	cm. stampo/mold	kg.
47880R04	48x56 h. 15	60x61 h. 15	7



Chiave di Sol - Treble clef
G-Schlüssel - Clef triple - Nota musicale

art.	cm. scultura/sculpture	cm. stampo/mold	kg.
47880R05	36x26 h. 67	50x26 h. 78	7,5



Poseidone - Poseidon

art.	cm. scultura/sculpture	cm. stampo/mold	kg.
47880R12	48x56 h. 19	71x56 h. 20	5,5

BAR HAPPY HOUR BUFFET



Cigno - Swan
Schwan - Cygne - Cisne

art.	cm. scultura/sculpture	cm. stampo/mold	kg.
47880R01	42x26 h. 53	60x25 h. 65	7



Ancora - Anchor
Anker - Ancre - Ancle

art.	cm. scultura/sculpture	cm. stampo/mold	kg.
47880R02	47x26 h. 56	67x29 h. 62	8



Sposi - Bridegrooms
Ehepaar - Epoux - Esposi

art.	cm. scultura/sculpture	cm. stampo/mold	kg.
47880R07	41x41 h. 83	51x96 h. 41	9



Pesce - Fish
Fisch - Poisson - Pez

art.	cm. scultura/sculpture	cm. stampo/mold	kg.
47880R08	58x25 h. 56	69x25 h. 70	8



Sirena - Mermaid
Seejungfer - Sirène - Sirena

art.	cm. scultura/sculpture	cm. stampo/mold	kg.
47880R10	46x33 h. 86	60x100 h. 33	8



Cavalluccio marino - Seahorse
Seepferdchen - Morse - Caballito de mar

art.	cm. scultura/sculpture	cm. stampo/mold	kg.
47880R11	47x26 h. 56	67x29 h. 62	8



Demetra - Demeter
Demetra

art.	cm. scultura/sculpture	cm. stampo/mold	kg.
47880R18	51 h. 22	63 h. 24	5



Artemide - Artemis
Artemide

art.	cm. scultura/sculpture	cm. stampo/mold	kg.
47880R17	39 h. 15	53 h. 19	4,5



Coltello ghiaccio
Ice knife
Eis-Messer
Couteau à glace
Cuchillo para hielo

art.	l. cm.	kg.
47885-01	25	0,12



Scalpello ghiaccio a V
V shape chisel
Eismeissel
Ciseau à glace
Cinsel a V para hielo

art.	l. cm.	kg.
47885-02	31,5	0,28



Scalpello ghiaccio 3 lati smussati
Medium flat chisel
Eismeissel
Ciseau à glace
Cinsel para hielo

art.	l. cm.	kg.
47885-03	50	0,45



Scalpello ghiaccio un lato smussato
Big flat chisel
Eismeissel
Ciseau à glace
Cinsel para hielo

art.	l. cm.	kg.
47885-04	74,5	0,78



Set 4 pezzi scalpelli ghiaccio
Four pieces ice chisel set
Eismeissel set 4 stück
4 pcs set ciseau à glace
Cinseles para hielo, 4 piezas

art.
47885-05



Cannello professionale
Chef's torch
Profi-Wärmepistole
Chalumeau de cuisine
Soplete cocina

art.	dim. cm.	ml.	gr.
47841-03	8x7x16	200	220

P



Cannello professionale
Chef's torch
Profi-Wärmepistole
Chalumeau de cuisine
Soplete cocina

art.	dim. cm.	ml.	gr.
47841-04	12x7x18	280	420



Cannello con accensione elettronica a fiamma regolabile. Serbatoio ricaricabile con gas per accendino. Pratico da tenere in mano. Indispensabile per tutti i lavori di incollaggio dello zucchero e per crème brûlée, torte di ricotta, meringa, sculture in ghiaccio, crostata di frutta, etc. *Mini torch with automatic ignition, adjustable flame. To be filled with gas for lighters. Easy to use. Necessary for gluing sugar works and crème brûlée, cheese cake, meringue cake, ice sculptures, fruit tarts, etc.*

ATLANTIC BUFFET SYSTEM



Pensati e ideati nelle versioni rotonde, rettangolari con aperture differenziate per soddisfare ogni esigenza, gli scaldavivande ABS-Atlantic Buffet System interpretano la funzionalità e la flessibilità contemporanea. Semplici nella forma, impilabili, igienici poiché realizzati in acciaio inox, facilmente smontabili in tutte le loro parti per una pulizia impeccabile, gli elementi appartenenti alla linea nascono dall'expertise che solo Sambonet Paderno è in grado di garantire alla ristorazione d'eccellenza. Grazie alla trasparenza del nuovo oblò in vetro temperato, i coperchi offrono visibilità alla prelibatezza dei contenuti degli scaldavivande. Il meccanismo di chiusura graduale e lo speciale metodo di rimozione dei coperchi rende ancora più performante l'intero Sistema.

Conceived and designed in the round and rectangular versions with different opening systems to meet any need ABS-Atlantic Buffet System chafing dishes combine contemporary flexibility and functionality. All the parts of these simple-shaped, stackable, 100% stainless steel hygienic items can be easily taken apart for thorough cleaning. The line comes from the expertise that only Sambonet Paderno can offer to top catering services. The lid is equipped with a new, transparent window made of unbreakable glass that lets you see the delicacies held in the chafing dishes. The gradual closing mechanism and the special lid removal method make the whole System even more effective.



ABS Round - Acciaio 18-10 - Stainless steel

ABS Rectangular - Acciaio 18-10 - Stainless steel

ART.	Ø CM.	H. CM.	Lt.
58176-30	30	15	2,75
58176-36	36	15	5,00
58176-40	40	17	7,80

ART.	DIM. CM.	H. CM.	Lt.
58172-54	57x47	18	10



58172-56	68,5x35,5	18	10
----------	-----------	----	----

58166-24	24	15	2,00
58166-30	30	15	2,75
58166-36	36	15	5,00
58166-40	40	17	7,80



58162-54	57x47	18	10
----------	-------	----	----



58162-56	68,5x35,5	18	10
----------	-----------	----	----

58166-AA	24	58162-AA	57x47
58166-AM	30		
58166-AB	36		
58166-AC	40		



Dotati di vasca GN 1/1, h 65 mm. - Equipped with pan GN 1/1, h 65 mm.

Gli scaldavivande ABS-Atlantic Buffet System sono ideati per ogni tipo di cottura, gas, elettrica, vetroceramica e induzione* per la quale si raccomanda l'utilizzo delle piastre proposte dall'azienda, disponibili sia nella versione da appoggio art. 58162-RA sia da incasso art. 58162-RB. Questi piani ad induzione sono infatti l'ideale per tutti i buffet ove indispensabile mantenere i cibi ad una temperatura ottimale per la conservazione dei sapori.

ABS-Atlantic Buffet System chafing dishes can be used on any heat source, gas, electric, glass-ceramic and induction. We recommend our free-standing (58162-RA) and built-in (58162-RB) cookers. As a matter of fact, these induction cookers are ideal for any buffet where food should be kept at a specific temperature to preserve flavours.*



*NON UTILIZZABILI su piani ad induzione con riconoscimento di frequenza. - NOT SUITABLE for induction hobs with frequency identification.



Piastra ad induzione, da incasso
Induction cooker, to be built into counter
Induktionsplatte, thekeneinbau
Plaque à induction, montage an comptoir
Placa a inducción para emportar

art.	dim. cm.	h.	V	W	kg.
58162-RB	36X38	12,5	220-240	500-3500	5,7

Piano in vetroceramica Schott, timer 0-180 minuti, 1-10 livelli di potenza, temperatura 60-240°C. - Schott ceran hob, timer (0-180 min.), 1-10 power levels, temperature range 60°C-240°C.



Piastra ad induzione
Induction cooker
Induktionsplatte
Plaque à induction
Placa a inducción

art.	dim. cm.	h.	V	W	kg.
58162-RA	30X37	10	220-240	500-2700	6

Corpo inox, piano in vetroceramica Schott, display a led, timer 0-180 minuti, 1-10 livelli di potenza, temperatura 60-240°C. - Stainless steel body, Schott ceran hob, led display, timer (0-180 min.), 1-10 power levels, temperature range 60°C-240°C.

	Descrizione - Description	Art.	dim. cm.	h.	lt.
	Elemento elettrico EU per ABS rettangolari - 220V - 380W <i>Electric heating unit EU for rectangular ABS</i>	58162-KE	20x25		
	Elemento elettrico US per ABS rettangolari - 110V - 450W <i>Electric heating unit US for rectangular ABS</i>	58162-KU	20x25		
	Elemento elettrico EU per ABS tondo ø24 - 220V - 80W <i>Electric heating unit EU for ø24 round ABS</i>	58341-KE	ø13,5		
	Elemento elettrico US per ABS tondo ø24 - 110V - 170W <i>Electric heating unit US for ø24 round ABS</i>	58341-KU	ø13,5		
	Elemento elettrico EU per ABS tondo ø30 - 220V - 180W <i>Electric heating unit EU for ø30 round ABS</i>	58166-KP	20x21		
	Elemento elettrico EU per ABS tondo ø36-40 - 220V - 200W <i>Electric heating unit EU for ø36-40 round ABS</i>	58166-KE	20x25		
	Elemento elettrico US per ABS tondo ø36-40 - 110V - 240W <i>Electric heating unit US for ø36-40 round ABS</i>	58166-KU	20x25		
	Termoregolatore EU per ABS rettangolari e tondi ø36-40 <i>Thermoregulator EU for rectangular and round ø36-40 ABS</i>	58132-AE			
	Termoregolatore US per ABS rettangolari e tondi ø36-40 <i>Thermoregulator US for rectangular and round ø36-40 ABS</i>	58132-AU			
	Set portacombustibile solido per ABS ø24-30-36 <i>Fuel holder kit for ABS ø24-30-36</i>	58136-KA			
	Set portacombustibile solido per ABS rettangolari e ø40 <i>Fuel holder kit for ABS rectangular and ø40</i>	58132-KA			
	Inserto porcellana <i>Porcelain food pan</i>	58166-EL	ø30		
		58166-EC	ø36		
	Inserto porcellana <i>Porcelain food pan</i>	58166-ED	ø36		
	Legumiera, acciaio inox <i>Vegetable dish, stainless steel</i>	58166-EG	ø24		
		58166-EM	ø30		
		58166-EH	ø36		
		58166-EI	ø40		

ABS Round - Acciaio 18-10 - Stainless steel

ART.	Ø Cm.	H.	Lt.	V	W
Riscaldamento a combustibile solido - <i>Solid fuel heating</i>					
58166A24	24	27	2,00		
58166A30	30	27	2,75		
58166A36	36	27	5,00		
58166A40	40	28	7,80		
Riscaldamento elettrico, EU - <i>Electric heating, EU</i>					
58166E24	24	27	2,00	250	80
58166E30	30	27	2,75	250	190
58166E36	36	27	5,00	250	190
58166E40	40	28	7,80	250	190
Riscaldamento elettrico, US - <i>Electric heating, US</i>					
58166U24	24	27	2,00	120	170
58166U36	36	27	5,00	120	240
58166U40	40	28	7,80	120	240



ABS Round - Acciaio 18-10 - Stainless steel

ART.	Ø Cm.	H.	Lt.	V	W
Riscaldamento a combustibile solido - <i>Solid fuel heating</i>					
58176A30	30	27	2,75		
58176A36	36	27	5,00		
58176A40	40	28	7,80		
Riscaldamento elettrico, EU - <i>Electric heating, EU</i>					
58176E30	30	27	2,75	250	190
58176E36	36	27	5,00	250	190
58176E40	40	28	7,80	250	190
Riscaldamento elettrico, US - <i>Electric heating, US</i>					
58176U36	36	27	5,00	120	240
58176U40	40	28	7,80	120	240



Petite Marmitte - Acciaio 18-10 - Stainless steel

ART.	Ø Cm.	H.	Lt.	V	W
Riscaldamento a combustibile solido - <i>Solid fuel heating</i>					
58168A24	24	35	7,00		
Riscaldamento elettrico, EU - <i>Electric heating, EU</i>					
58168E24	24	35	7,00	250	80
Riscaldamento elettrico, US - <i>Electric heating, US</i>					
58168U24	24	35	7,00	120	170
Zuppiera senza coperchio - <i>Soup-tureen without cover</i>					
58168-GA	24		7,00		



ABS Rectangular - Acciaio 18-10 - Stainless steel

ART.	DIM. CM.	H.	Lt.	V	W
Riscaldamento a combustibile solido - <i>Solid fuel heating</i>					
58162A54	57x47	30,5	10		
Riscaldamento elettrico, EU - <i>Electric heating, EU</i>					
58162E54	57x47	30,5	10	250	360
Riscaldamento elettrico, US - <i>Electric heating, US</i>					
58162U54	57x47	30,5	10	120	450



ABS Rectangular - Acciaio 18-10 - Stainless steel

ART.	DIM. CM.	H.	Lt.	V	W
Riscaldamento a combustibile solido - <i>Solid fuel heating</i>					
58172A54	57x47	30,5	10		
Riscaldamento elettrico, EU - <i>Electric heating, EU</i>					
58172E54	57x47	30,5	10	250	360
Riscaldamento elettrico, US - <i>Electric heating, US</i>					
58172U54	57x47	30,5	10	120	450



ART.	DIM. CM.	H.	Lt.	V	W
Riscaldamento a combustibile solido - <i>Solid fuel heating</i>					
58162A56	68,5x35,5	30,5	10		
Riscaldamento elettrico, EU - <i>Electric heating, EU</i>					
58162E56	68,5x35,5	30,5	10	250	360
Riscaldamento elettrico, US - <i>Electric heating, US</i>					
58162U56	68,5x35,5	30,5	10	120	450



Dotati di vasca GN 1/1, h 65 mm. - *Equipped with pan GN 1/1, h 65 mm.*

ART.	DIM. CM.	H.	Lt.	V	W
Riscaldamento a combustibile solido - <i>Solid fuel heating</i>					
58172A56	68,5x35,5	30,5	10		
Riscaldamento elettrico, EU - <i>Electric heating, EU</i>					
58172E56	68,5x35,5	30,5	10	250	360
Riscaldamento elettrico, US - <i>Electric heating, US</i>					
58172U56	68,5x35,5	30,5	10	120	450



Dotati di vasca GN 1/1, h 65 mm. - *Equipped with pan GN 1/1, h 65 mm.*



Asia Rectangular - Acciaio 18-10 - Stainless steel

ART.	DIM. CM.	H.	LT.	KG	V	W
Riscaldamento a combustibile solido - <i>Solid fuel heating</i>						
58132A54	67,5x44	42	10	20		
Riscaldamento elettrico, EU - <i>Electric heating, EU</i>						
58132E54	67,5x44	42	10	20	250	360
Riscaldamento elettrico, US - <i>Electric heating, US</i>						
58132U54	67,5x44	42	10	20	120	450



Riscaldamento a combustibile solido - <i>Solid fuel heating</i>						
58132A55	67,5x44	34,5	10	20		
Riscaldamento elettrico, EU - <i>Electric heating, EU</i>						
58132E55	67,5x44	34,5	10	20	250	360
Riscaldamento elettrico, US - <i>Electric heating, US</i>						
58132U55	67,5x44	34,5	10	20	120	450



Dotati di vasca GN 1/1, h 65 mm. - *Equipped with pan GN 1/1, h 65 mm.*

Asia Round - Acciaio 18-10 - Stainless steel

ART.	Ø CM.	H.	LT.	KG	V	W
Riscaldamento a combustibile solido - <i>Solid fuel heating</i>						
58136A33	33	44	3,5			
58136A40	40	58	6,0			
Riscaldamento elettrico, EU - <i>Electric heating, EU</i>						
58136E33	33	44	3,5	13	250	200
58136E40	40	58	6,0	25	250	360
Riscaldamento elettrico, US - <i>Electric heating, US</i>						
58136U33	33	44	3,5	13	120	240
58136U40	40	58	6,0	25	120	450



Riscaldamento a combustibile solido - <i>Solid fuel heating</i>						
58136A34	33	34,5	3,5			
58136A41	40	43,0	6,0			
Riscaldamento elettrico, EU - <i>Electric heating, EU</i>						
58136E34	33	34,5	3,5	13	250	200
58136E41	40	43,0	6,0	25	250	360
Riscaldamento elettrico, US - <i>Electric heating, US</i>						
58136U34	33	34,5	3,5	13	120	240
58136U41	40	43,0	6,0	25	120	450



Asia 2000 Rectangular - Acciaio 18-10 - S/S

ART.	DIM. CM.	H.	Lt.	V	W
Riscaldamento a combustibile solido - <i>Solid fuel heating</i>					
58152A54	67x49	44	10		
Riscaldamento elettrico, EU - <i>Electric heating, EU</i>					
58152E54	67x49	44	10	250	360
Riscaldamento elettrico, US - <i>Electric heating, US</i>					
58152U54	67x49	44	10	120	450



Dotati di vasca GN 1/1, h. 65 mm. - *Equipped with pan GN 1/1, h. 65 mm.*

Coffee Urn - Acciaio 18-10 - Stainless steel

ART.	H.	Lt.	V	W
Riscaldamento elettrico, EU - <i>Electric heating, EU</i>				
58355E06	50	6	230	500
58355E09	57	9	230	500
58355E12	65	12	230	500
Riscaldamento elettrico, US - <i>Electric heating, US</i>				
58355U06	50	6	115	500
58355U09	57	9	115	500
58355U12	65	12	115	500



Asia 2000 Round - Acciaio 18-10 - Stainless steel

ART.	Ø CM.	H.	Lt.	V	W
Riscaldamento a combustibile solido - <i>Solid fuel heating</i>					
58156A33	33	47	3,5		
58156A40	40	61	6,0		
Riscaldamento elettrico, EU - <i>Electric heating, EU</i>					
58156E33	33	47	3,5	250	200
58156E40	40	61	6,0	250	360
Riscaldamento elettrico, US - <i>Electric heating, US</i>					
58156U33	33	47	3,5	120	240
58156U40	40	61	6,0	120	450



Coffee Urn - Acciaio 18-10 - Stainless steel

ART.	H.	Lt.	V	W
Riscaldamento a combustibile solido - <i>Solid fuel heating</i>				
58351A06	53	6		
58351A09	59	9		
58351A12	69	12		
58351A18	85	18		



Disponibile anche nella versione elettrica (vedi listino).
Available also with electric heating unit (see price-list).

Acciaio 18-10 - Stainless steel

ART.	DIM. CM.	H.	Lt.	V	W
Riscaldamento a combustibile solido - <i>Solid fuel heating</i>					
41693A54	64x35	40	10		
Riscaldamento elettrico, EU - <i>Electric heating, EU</i>					
41693E54	64x35	40	10	250	360
Riscaldamento elettrico, US - <i>Electric heating, US</i>					
41693U54	64x35	40	10	120	450



Dotati di vasca GN 1/1, h 65 mm.
Equipped with pan GN 1/1, h 65 mm.

ART.	DIM. CM.	H.	L.T.
Riscaldamento a combustibile solido <i>Solid fuel heating</i>			
41989A00	67x35	35	9



Dotato di vasca GN 1/1, h 65 mm
e 2 portacombustibili.
Equipped with food pan GN 1/1, h 65 mm
and 2 burner holders.

ART.	DIM. CM.	H.	L.T.
Riscaldamento a combustibile solido <i>Solid fuel heating</i>			
41989A01	67x35	45	9



Dotato di vasca GN 1/1, h 65 mm
e 2 portacombustibili.
Equipped with food pan GN 1/1, h 65 mm
and 2 burner holders.

Acciaio 18-10 - Stainless steel

ART.	DIM. CM.	H.	Lt.	V	W
Riscaldamento a combustibile solido - <i>Solid fuel heating</i>					
41694A54	64x35	40	10		
Riscaldamento elettrico, EU - <i>Electric heating, EU</i>					
41694E54	64x35	40	10	250	360
Riscaldamento elettrico, US - <i>Electric heating, US</i>					
41694U54	64x35	40	10	120	450



Dotati di vasca GN 1/1, h 65 mm.
Equipped with pan GN 1/1, h 65 mm.

ART.	DIM. CM.	H.	KG
Riscaldamento a combustibile solido <i>Solid fuel heating</i>			
41694A02	64x35	33	10



Fornito con 2 portacombustibili.
Equipped with 2 fuel-holders.

ART.	Ø CM.	H.	KG
Scaldavivande per agnello <i>Lamb chafing-dish</i>			
Riscaldamento a combustibile solido <i>Solid fuel heating</i>			
41694A60	66	30	17



Fornito con 4 portacombustibili.
Equipped with 4 fuel-holders.

	Descrizione - Description	Art.	dim. cm.	h.	lt.
	Targhette per scaldacaffè, inox <i>Coffee urn plates, stainless steel</i>	58341-EC 58341-EW 58341-EM 58341-ET	11x33 11x33 11x33 11x33	Coffee Water Milk Tea	
	Portavivande tondo, inox <i>Round food pan, stainless steel</i>	58136-EA 58136-EB	ø33 ø40	6,0 7,5	3,5 6,0
	Portavivande tondo, porcellana <i>Round food pan, porcelain</i>	44352-30 44352-40	ø33 ø40	5,7 7,5	
	Portavivande tondo 2 scomparti, porcellana <i>Round food pan 2 sections, porcelain</i>	44355-30 44355-40	ø33 ø40	5,7 7,5	
	Portavivande GN 1/1, inox <i>Food pan GN 1/1, stainless steel</i>	14102-04 14102-06	53x32,5 53x32,5	4,0 6,5	
	Portavivande GN 1/1, porcellana <i>Food pan GN 1/1, porcelain</i>	44332-03 44332-06	53x32,5 53x32,5	2,0 6,5	
	Portacombustibile, inox. Adatto per gli scaldavivande art. 41693 e 41694 <i>Fuel holder, s/s. Suitable for chafing dishes items 41693 and 41694</i>	41809-09	ø9	6,5	
	Portacombustibile, inox. Adatto per gli scaldavivande art. 58152 e 58156 <i>Fuel holder, s/s. Suitable for chafing dishes items 58152 and 58156</i>	58132-FB	ø10	7,5	
	Portacombustibile, inox. Adatto per gli scaldacaffè art. 58351 <i>Fuel holder, s/s. Suitable for coffee urn item 58351</i>	58132-FA	ø10	5,5	
	Elemento elettrico EU per rettangolari e tondi ø40 - 220V - 380W <i>Electric heating unit EU for rectangular and round ø40</i>	58132-KE	20x25		
	Elemento elettrico US per rettangolari e tondi ø40 - 110V - 450W <i>Electric heating unit US for rectangular and round ø40</i>	58132-KU	20x25		
	Elemento elettrico EU per tondo ø33 - 220V - 200W <i>Electric heating unit EU for ø33</i>	58136-KE	20x20		
	Elemento elettrico US per tondo ø33 - 110V - 240W <i>Electric heating unit US for ø33</i>	58136-KU	20x20		
	Elemento elettrico EU per scaldacaffè art. 58351 - 220V - 80W <i>Electric heating unit EU for coffee urn item 58351</i>	58341-KE	ø13,5		
	Elemento elettrico US per scaldacaffè art. 58351 - 110V - 170W <i>Electric heating unit US for coffee urn item 58351</i>	58341-KU	ø13,5		
	PYROGEL® Gel combustibile Jelly fuel Brenngel Gel combustibile Combustible gel	41695-15 41695-10 41695-50 41695-90	gr.200 lt. 1 lt. 5 lt. 10	u.pack: 2 Kg. 4 Kg. 8	



Samovar, inox
Samovar, stainless steel
Samovar, Edelstahl Rostfrei
Samovar, inox
Samovar, acero inox

art.	h.	lt.
58357E06	66	6+1,0*
58357E09	74	9+1,0*
58357E12	82	12+1,6*

230V - 1000W. *Teiera - Tea pot.
Disponibile- Available: 115V - 1000W.



Samovar, inox
Samovar, stainless steel
Samovar, Edelstahl Rostfrei
Samovar, inox
Samovar, acero inox

art.	dim. cm.	h.	lt.
49856-10	39x46	58	10

230V - 700/3000W. Teiera/Tea pot: 1,5 lt.



Samovar, inox
Samovar, stainless steel
Samovar, Edelstahl Rostfrei
Samovar, inox
Samovar, acero inox

art.	dim. cm.	h.	lt.
49856-04	28x28	41,5	4

230V - 500/2500W. Teiera/Tea pot: 1 lt.



Samovar, inox
Samovar, stainless steel
Samovar, Edelstahl Rostfrei
Samovar, inox
Samovar, acero inox

art.	dim. cm.	h.	lt.
49855-05	31x28	58	5

230V - 500/1800W. Teiera/Tea pot: 1,3 lt.



Samovar, inox
Samovar, stainless steel
Samovar, Edelstahl Rostfrei
Samovar, inox
Samovar, acero inox

art.	dim. cm.	h.	lt.
49855-15	42x37	72	15

230V - 700/3000W. Teiera/Tea pot: 2 lt.



Samovar, inox
Samovar, stainless steel
Samovar, Edelstahl Rostfrei
Samovar, inox
Samovar, acero inox

art.	dim. cm.	h.	lt.
49855-10	32,5x44,5	69	10

230V - 3000W. Teiera/Tea pot: 1,6 lt.



Scatola portabustine thè, acrilico
Tea-box, acrylic
Teebox, Acryl
Boîte à sachets de thé, acrilique
Caja para bolsitas de té, acrílico

art.	dim. cm.	h.
41614-22	22x17	9



Scatola portabustine thè, legno
Tea-box, wood
Teebox, Holz
Boîte à sachets de thé, bois
Caja para bolsitas de té, madera

art.	dim. cm.	h.
41614-33	33,5x20	9
41614-35	31x28	9



Scatola portabustine thè, legno
Tea-box, wood
Teebox, Holz
Boîte à sachets de thé, bois
Caja para bolsitas de té, madera

art.	dim. cm.	h.
41614-34	33,5x20	9
41614-36	31x28	9



Vassoio room service, noce
Room service tray, walnut
Zimmerservice-Tablett. Nussbraun
Plateau room-service, noyer
Bandeja roo service, nuez

art.	dim. cm.
19901-35	52x35
19901-40	60x40
19901-47	71x47



Caffettiera pressa filtro, inox
French press, stainless steel
Kaffeebereiter, Edelstahl Rostfrei
Cafetière à piston, inox
Cafetera, inox

art.	ml.
41649-03	350
41649-06	600



Espositore coffee-station
Coffee-Station
Kaffee-Station
Station café
Estación de café

art.	dim. cm.	h.
41613-45	45x34	16



Scaldacaffè
Coffee urn
Kaffeedispenser
Réchaud à café
Calentador de café

art.	dim. cm.	h.	lt.
41903-10	31x33,5	54,5	10,5



Caffettiera elettrica
Coffee maker, electric
Kaffeeautomat
Cafetière électrique
Cafetera eléctrica

art.	ø cm.	h.	lt.	V	W
49848-10	25,7	53	10	230	1520
49848-15	25,7	62	15	230	1520
49848-BB	200 filtri/filters				



Caffettiera elettrica
Coffee maker, electric
Kaffeeautomat
Cafetière électrique
Cafetera eléctrica

art.	ø cm.	h.	lt.	V	W
49848-05	18,5	48	5	230	1115
49848-BA	200 filtri/filters				



Ciocolatiera
Chocolate dispenser
Schokolademaschine
Chocolatière
Chocolatera

art.	lt.	V	W	Hz
49954-25	5	230	1100	50



Bollitore d'acqua, inox
Boiler, stainless steel
Kessel, Edelstahl Rostfrei
Chauffe-eau, inox
Caldera acero inox

art.	ø cm.	h.	lt.	Kg
49954-20	47	48	20	5,7
220-240V - 2100W.				



Zuppiera
Soup warmer
Suppenwärmer
Marmite à soupe
Ollas para sopa

art.	ø cm.	h.	lt.
49790-09	48	32	10
Per induzione. - Suitable for induction.			



Zuppiera elettrica
Soup warmer, electric
Suppenwärmer, elektrisch
Marmite à soupe, électrique
Ollas para sopa, eléctrica

art.	ø cm.	h.	lt.	V	W
49847-08	32	36	9	230	400



Zuppiera elettrica, duo
Electric soup warmer, double
Duo Suppenstation, elektrisch
Marmite à soupe double, électrique
Baño maria doble, eléctrica

art.	dim. cm.	h.	lt.	V	W
49847-16	34x57	35	2x8	230	1200



Lampada ad infrarossi, cromata
Infrared lamp, chromed
Infrarot-Wärmestrahler, chromiert
Lampe chauffante infra-rouge, chromate
Lampara a rayos infrarojos, cromado

art.	dim. cm.	h.	V	W
49991-11	64x28	86	230	250



Lampada ad infrarossi, cromata
Infrared lamp, chromed
Infrarot-Wärmestrahler, chromiert
Lampe chauffante infra-rouge, chromate
Lampara a rayos infrarojos, cromado

art.	dim. cm.	h.	V	W
49991-21	75x53	72	230	500
49991-31	103x53	72	230	750



Lampada ad infrarossi con piano caldo
Infrared lamp with warming plate
Infrarot-Wärmestrahler u. Speisewärmer
Lampe infra-rouge avec plaque chauffante
Lampara con plancha caliente

art.	dim. cm.	h.	V	W
49992-11	36x56	72	230	700



Lampada ad infrarossi con piano caldo
Infrared lamp with warming plate
Infrarot-Wärmestrahler u. Speisewärmer
Lampe infra-rouge avec plaque chauffante
Lampara con plancha caliente

art.	dim. cm.	h.	V	W
49992-21	69x56	83	230	700



Lampada ad infrarossi con piano caldo
Infrared lamp with warming plate
Infrarot-Wärmestrahler u. Speisewärmer
Lampe infra-rouge avec plaque chauffante
Lampara con plancha caliente

art.	dim. cm.	h.	V	W
49992-31	104x56	83	230	1400

CARRELLI SALA DINING ROOM TROLLEYS



Struttura portante, piani di servizio in legno multistrato con bordi massicci. Gambe in massello di faggio. Finitura standard tinta palissandro. Su richiesta colori: noce, mogano e rovere. Ruote standard in gomma antistatica, optional ruote in poliuretano. Tutti i carrelli possono essere dotati di profilo paraurti.

Main structure and tops in plywood with reinforced edges. Legs in beechwood. Standard finishing rosewood color. Other colors: walnut, mahogany and oak. Standard swivel casters in antistatic rubber, on request polyurethane casters. All trolleys are available equipped with rubber bumper.

CARRELLI TROLLEY



58874-22 CE

Carrello arrosti/bolliti
Roast beef/stew trolley
Rinderbrust-/Fleischgerichtewagen
Chariot à rôtis
Carro roast beef

art.	dim.cm.	h.	Kg.	Volt	Watt
58874-11	126x62	109	54	120	600
58874-22	126x62	109	54	230	700

Cloche in acciaio inossidabile 18-10 lucido a specchio con apertura a scomparsa a 180° - 4 ruote pivotanti di cui 2 con freno - vasca bagnomaria con 3 portavivande GN 1/2 in acciaio inox da lt 10 cad., h cm 15 - 1 tagliere mobile in wilsonart, mm 354x265 - portapiatti ribaltabile e portacoltelli estraibile in acciaio inox 18-10 - 2 rubinetti di scarico a sfera - 2 piastre elettriche da 700W cad. - 1 spina ad incasso (posteriore carrello) - 3 prese ad incasso (sotto piano carrello) - 2 spine a pipa - cavo di alimentazione - 3 interruttori di cui 1 magnetotermico. Su richiesta è possibile fornire il carrello dotato di piano intermedio.

18-10 stainless steel revolving top adjustable up to 180°, mirror polish finishing - 4 swivel casters, 2 with brakes, bain-marie tank equipped with 3 GN 1/2 stainless steel containers, 10 litres each, height 15 cm - 1 removable wilsonart cutting board mm 354x265 - revolving plate rack and removable knife holder in 18-10 stainless steel - 2 taps for water discharge - 2 heating units 700W each - 1 built in plug, backside - 3 built-in plugs, deck downside - 2 pipe plugs - cable - 3 switches, (1 magneto-termic). Upon request, the trolley can be supplied equipped with intermediate shelf.



CE

Carrello flambé
Flambé trolley
Flambierwagen
Chariot à flamber
Carro flambé

art.	dim. cm.	h.	Kg.
58876-00	122x58,5	89,5	44,5

4 ruote pivotanti di cui 2 con freno - pianale inox mm 540x1042 completo di barriera portabottiglie - 2 piani d'appoggio inferiori in legno - vano porta bombole con sportello di chiusura - gruppo gas/bruciatore/accenditore - dispositivo di accensione piezoelettrico - funzionamento a gas liquido butano in bombola ricaricabile da kg 2,75 (autonomia 20 ore circa) oppure da kg 1,8 - bombola NON fornita.

4 swivel casters, 2 with brakes - upper deck in 18-10 stainless steel mm 540x1042 with bottle holder protection ring - 2 lower wooden decks - cabinet for gas cylinder - gas/burning/lighting unit - piezoelectric lighting device - operating with liquid butan gas, 2,75 kg rechargeable cylinder (lasting for 20 hours about) or 1,8 kg cylinder - trolley supplied without cylinder.



CE

Carrello flambé, elettrico
Flambé trolley, electric
Flambierwagen, elektrisch
Chariot à flamber, électrique
Carro flambé, eléctrico

art.	dim. cm.	h.	Kg.
58876-01	122x58,5	89,5	44,5

4 ruote pivotanti di cui 2 con freno - pianale inox mm 540x1042 completo di barriera perimetrale - 2 piani d'appoggio inferiori in legno - piastra elettrica high-light da incasso ø 32 cm, piano riscaldante in vetroceramica ø 26 cm, alimentazione 230V-2300W - 1 spina ad incasso (posteriore carrello) - cavo di alimentazione - regolatore di energia ed interruttore magnetotermico.

4 swivel casters, 2 with brakes - upper deck in 18-10 stainless steel mm 540x1042 with protection ring - 2 lower wooden decks - built-in electric heating unit, high-light, ø 32 cm, ceramic heating surface ø 26 cm, power 230V-2300W - 1 built-in plug, backside - cable - adjustable heat control unit and 1 magneto termic switch.



CE

Carrello flambé, 2 fuochi
Flambé trolley, 2 burners
Flambierwagen, 2 Brenner
Chariot à flamber, 2 feux
Carro flambé, 2 fuegos

art.	dim. cm.	h.	Kg.
58877-00	122x58,5	89,5	46,5

4 ruote pivotanti di cui 2 con freno - pianale inox mm 540x1042 completo di barriera perimetrale - 2 piani d'appoggio inferiori in legno - vano porta bombole con sportello di chiusura - 2 gruppi gas/bruciatore/accenditore - dispositivo di accensione piezoelettrico - funzionamento a gas liquido butano in bombola ricaricabile da kg 2,75 (autonomia 20 ore circa) oppure da kg 1,8 - bombola NON fornita.

4 swivel casters, 2 with brakes - upper deck in 18-10 stainless steel mm 540x1042 with protection ring - 2 lower wooden decks - cabinet for gas cylinder - 2 gas/burning/lighting units - piezoelectric lighting device - operating with liquid butan gas, 2,75 kg rechargeable cylinder (lasting for 20 hours about) or 1,8 kg cylinder - trolley supplied without cylinder.



CE

Carrello mini-flambé
Mini flambé trolley
Flambierwagen, Mini-Ausführung
Chariot à flamber, mini
Mini carro flambé

art.	dim. cm.	h.	Kg.
58875-00	77,5x51	74,5	22

4 ruote pivotanti, senza freno - piano superiore in acciaio inox 18-10, satinato - vano inferiore con portabottiglie.

4 swivel casters without brakes - upper deck in 18-10 stainless steel, satin finishing - lower deck with bottle holder.



Carrello antipasti
Hors d'oeuvre trolley
Vorspeisewagen
Chariot à hors d'oeuvres
Carro entremeses

art.	dim. cm.	h.	Kg.
58878-00	122x62	106	38

4 ruote pivotanti di cui 2 con freno - cupola in metacrilato, con apertura a scomparsa - piano porta-vaschette antipasti in acciaio inox 18-10 con barriera perimetrale - 9 vaschette antipasti in vetro, dim. mm 123 x 203. Su richiesta è possibile fornire il carrello dotato di piano intermedio.

4 swivel casters, 2 with brakes - metacrilat revolving cloche - hors d'oeuvre inserts carrying deck in 18-10 stainless steel with protection ring - 9 hors d'oeuvre glass inserts, mm 123x203. Upon request, the trolley can be supplied equipped with intermediate shelf.



Carrello antipasti, refrigerato
Cooled hors d'oeuvre trolley
Vorspeisewagen, gekühlt
Chariot à hors d'oeuvres, réfrigéré
Carro entremeses, refrigerado

art.	dim. cm.	h.	Kg.
58879-00	122x62	106	38

4 ruote pivotanti di cui 2 con freno - cupola in metacrilato, con apertura a scomparsa - copertura vasca per contenitori eutettici in acciaio inox 18-10 - 8 contenitori eutettici da kg 1 cadauno, dim. mm 170 x 200 - 9 vaschette antipasti in vetro, dim. mm 123 x 203. Su richiesta è possibile fornire il carrello dotato di piano intermedio.

4 swivel casters, 2 with brakes - metacrilat revolving cloche - eutectic pads container with 18-10 stainless steel cover - 8 eutectic pads 2,2 lbs each, mm 170x200 - 9 hors d'oeuvre glass inserts, mm 123x203. Upon request, the trolley can be supplied equipped with intermediate shelf.



Carrello pasticceria Omicron
Pâtisserie trolley
Kuchen-/Nachspeisewagen
Chariot à pâtisserie
Carro postres

art.	dim. cm.	h.	Kg.
58880-00	113x56,5	104	57

Cupola tonda in metacrilato, montata su guide laterali, che ne permettono la rotazione nei due sensi - 4 ruote pivotanti di cui 2 con freno - 1 piano fisso in metacrilato mm 200x750 - 1 piano mobile in metacrilato mm 400x750 - 2 portapiatti ribaltabili in acciaio inox 18-10 - 2 piani d'appoggio inferiori in legno.

Metacrilat revolving cloche, bifrontal rotation - 4 swivel casters, 2 with brakes - 1 upper fixed deck in metacrilat mm 200x750 - 1 upper removable deck in metacrilat mm 400x750 - 2 revolving plate racks in 18-10 stainless steel - 2 lower wooden decks.



Carrello dolci-formaggi
 Cake and cheese trolley
 Dessert-/Käsewagen
 Chariot à fromages et desserts
 Carro postres/quesos

art.	dim. cm.	h.	Kg.
58882-00	122x62	106	38

4 ruote pivotanti di cui 2 con freno - cupola in metacrilato, con apertura a scomparsa - tagliere in texwood faggio naturale mm 728 x 424 - portapiatti ribaltabile in acciaio inox 18-10. Su richiesta è possibile fornire il carrello dotato di piano intermedio.

4 swivel casters, 2 with brakes - metacrilat revolving cloche - beech texwood cutting board mm 728x424 - revolving plate rack in 18-10 stainless steel. Upon request, the trolley can be supplied equipped with intermediate shelf.



Carrello dolci, refrigerato
 Cooled cake trolley
 Dessertwagen, gekühlt
 Chariot à desserts, réfrigéré
 Carro postres, refrigerado

art.	dim. cm.	h.	Kg.
58884-00	122x62	106	47,5

4 ruote pivotanti di cui 2 con freno - cupola in metacrilato, con apertura a scomparsa - vaschetta porta contenitori eutettici con copertura in acciaio inox 18-10 - 8 contenitori eutettici da kg 1 cadauno, mm 170x200 - portapiatti ribaltabile in acciaio inox 18-10. Su richiesta è possibile fornire il carrello dotato di piano intermedio.

4 swivel casters, 2 with brakes - metacrilat revolving cloche - eutectic pads container with 18-10 stainless steel cover - 8 eutectic pads 2,2 lbs each, mm 170x200 - revolving plate rack in 18-10 stainless steel. Upon request, the trolley can be supplied equipped with intermediate shelf.



Carrello mini-formaggi, refrigerato
 Cooled mini cheese trolley
 Käsewagen, gekühlt, Mini-Ausführung
 Chariot à fromages, réfrigéré, mini
 Mini carro quesos, refrigerado

art.	dim. cm.	h.	Kg.
58895-00	77,5x51	94	16,5

4 ruote pivotanti senza freno - cupola in metacrilato, con apertura a 90° - vaschetta porta contenitori eutettici (eutettici inclusi) con copertura in acciaio inox - 1 tagliere mobile, GN 1/1 - portapiatti ribaltabile in acciaio inox. 4 swivel casters without brakes - metacrilat roll-top cover, opening at 90° - eutectic pads container with stainless steel cover (eutectic pads incl.) - 1 removable cutting board, GN 1/1 - revolving plate rack in stainless steel.



Carrello gueridon, standard
 Standard gueridon trolley
 Gueridonwagen, Standard
 Chariot gueridon, standard
 Carro gueridon estándar

art.	dim. cm.	h.	Kg.
58886-00	77,5x51	74,5	14,5

4 ruote pivotanti, senza freno. Su richiesta è possibile fornire il carrello dotato di piano intermedio.

4 swivel casters without brakes. Upon request, the trolley can be supplied equipped with intermediate shelf.



Carrello gueridon, de luxe
 De luxe gueridon trolley
 Gueridonwagen, Luxus-Ausführung
 Chariot gueridon, de luxe
 Carro gueridon, de luxe

art.	dim. cm.	h.	Kg.
58887-00	77,5x51	74,5	16,5

4 ruote pivotanti, senza freno - cassettera a sei scomparti - piano d'appoggio estraibile.
 4 swivel casters without brakes - 6 compartments drawer - removable upper deck.



Carrello vini
 Wine trolley
 Weinwagen
 Chariot à vins
 Carro de vinos

art.	dim. cm.	h.	Kg.
58897-00	122x62	92	39

4 ruote pivotanti di cui 2 con freno - barriera porta bottiglie in acciaio inox - contenitore per tappi e carta vini - vano con 6 glacette (glacette incluse) - rastrelliera porta bicchieri, sotto piano carrello - piano inferiore con rastrelliera porta bottiglie, 12 posti.
 4 swivel casters, 2 with brakes - upper deck with stainless steel bottle holder ring - bottle caps and wine card compartment - 6 compartments for bottle coolers (bottle coolers included) - glass rack, deck downside - lower deck with bottle rack, 12 compartments.



Carrello liquori
 Liqueur trolley
 Aperitif-/Digestivwagen
 Chariot à liqueurs
 Carro licores

art.	dim. cm.	h.	Kg.
58889-00	124x68,5	104	37

4 ruote pivotanti di cui 2 con freno - barriera portabottiglie in acciaio inox 18-10.
 4 swivel casters, 2 with brakes - bottle holder protection ring in 18-10 stainless steel.



Carrello servizio
 Serving trolley
 Servierwagen
 Chariot à servir
 Carro de servicio

art.	dim. cm.	h.	Kg.
58891-00	122x58,5	89,5	35,5

4 ruote pivotanti di cui 2 con freno - piano estraibile e cassetto in legno. Su richiesta è possibile fornire il carrello dotato di piano intermedio.
 4 swivel casters, 2 with brakes - removable upper deck and wooden drawer. Upon request, the trolley can be supplied equipped with intermediate shelf.



Carrello sorbetti
Sherbet/ice cream trolley
Sorbetwagen
Chariot à sorbets/glacés
Carro sorbetes

art.	dim. cm.	h.	Kg.
58893-00	122x62	93	43

4 ruote pivotanti di cui 2 con freno - 4 sorbettiere termiche in acciaio inox 18-10 da lt 1,2 cadauna - cassetto porta-posate - portapiatti ribaltabile e portapalette-gelato in acciaio inox 18-10.

4 swivel casters, 2 with brakes - 4 18-10 stainless steel insulated sherbet holders (lt 1,2 each) - flatware drawer - revolving plate rack and ice cream scoops holder in stainless steel.



Carrello refrigerato
Refrigerated trolley
Kühlwagen
Chariot réfrigéré
Carro refrigerado

art.	dim. cm.	h.
49994-03	119x69	117

Struttura in laminato, disponibile in 10 varianti di colore. Particolari cromati. Vasca in acciaio inox con isolamento termico, dotata di rubinetto di scarico. Cupola in plexiglas apribile sui due lati. Gruppo compressore. Temperatura di esercizio +2° +8°C regolata da termostato digitale. 4 ruote di cui 2 con freno. Fornito con portapiatti ribaltabile lato e griglia in acciaio per l'esposizione di pesce fresco (P) o dolci/formaggi (D) (specificare uso). Capacità 3 GN 1/1 altezza massima 150 mm. Potenza 230V-405W.

Laminated structure available in 10 different colors. Chromed details. Stainless steel isolated tank with drain cock. Double side opening plexiglass dome. Compressor group. Working temperature +2° +8°C regulated by electronic thermostat. 4 castors, 2 with brake. Supplied with folding plate shelf on the long side and stainless steel grid for display of fresh fish (P) or desserts and cheese (D) (please specify). Capacity 3 food pans full size, max. height 150 mm. Rating 230V-405W.



Carrello tondo
Round trolley
Servierwagen, rund
Chariot rond
Carro redondo

art.	ø cm.	h.	Kg.
58888-00	60	89,5	23

4 ruote pivotanti, senza freno - piano d'appoggio laterale estraibile - barriera perimetrale. - 4 swivel casters without brakes - removable upper deck - perimeter barrier.



Carrello dolci/formaggi
Dessert and cheese trolley
Dessert-/Käsewagen
Chariot à fromages et desserts
Carro postres/quesos

art.	ø cm.	h.
49994-01	60	95
49994-02	60	95

Forniti smontati. Struttura in tubolare cromato e legno massello, nei colori noce, rovere o wengé. Dotati di 4 ruote cuffiate senza freno e pianetto ribaltabile. - To be assembled. Chromed tubular structure and solid wood, available in walnut, oak or wengé color. Equipped with 4 covered casters without brakes and revolving shelf.



Carrello portavassoi, filo cromato
Tray serving trolley, chromed wire
Tablettwagen, Metall verchromt
Chariot de service plateaux, chromé
Carrito para bandejas, cromado



art.	dim. cm.	h.	kg.
44094-20	60,5x40	99	7,5

Ideale per il servizio di mini colazioni.
Ideal for quick breakfast service.
Per vassoi/for trays: cm. 46x36

Carrello di servizio, PP
Serving trolley, PP
Mehrzweckwagen, PP
Chariot de service, PP
Carrito para desocupar, PP



art.	dim. cm.	h.
49995-04	97x51	99

Maniglie ergonomiche arrotondate, pannelli laterali e bordo paraurti arrotondato. Portata 135 kg (45 kg per ripiano). Ruote girevoli, antitraccia e silenziose. Colore nero. - *Swivel casters for easy manoeuvrability. Ergonomic handles, high load capacity (45 kg per shelf). Ultra-quiet mark-resistant casters. Black color.*



Carrello gueridon
Gueridon trolley
Gueridon-Wagen
Chariot gueridon
Carro gueridon

Carrello gueridon
Gueridon trolley
Gueridon-Wagen
Chariot gueridon
Carro gueridon

art.	dim. cm.	h.
49995-01	103x54	92

art.	dim. cm.	h.
49995-02	103x54	92

Fornito smontato. Struttura in tubo tondo cromato da abbinare a 10 colori in laminato per i ripiani. 4 ruote pivotanti di cui 2 con freno. - *To be assembled. Tubular chromed structure to be matched with 10 different colors of laminated shelves. 4 swivel casters, 2 with brakes.*



Carrello dolci/liquori
Dessert/liqueur trolley
Dessert-/Likörwagen
Chariot à desserts/liqueurs
Carro postres/licores

Carrello dolci
Dessert trolley
Dessert-Wagen
Chariot à desserts
Carro postres

art.	dim. cm.	h.
49995-03	103x54	103

art.	dim. cm.	h.
49994-04	103x54	103

Fornito smontato. Struttura in tubo tondo cromato e ripiani in laminato. 4 ruote pivotanti di cui 2 con freno. - *To be assembled. Tubular chromed structure with laminated shelves. 4 swivel casters, 2 with brakes.*

Fornito smontato. Struttura in tubo tondo cromato con inserti in legno massello. 4 ruote pivotanti di cui 2 con freno. - *To be assembled. Tubular chromed structure with wooden particulars. 4 swivel casters, 2 with brakes.*



PASTICCERIA
PASTRY UTENSILS
KONDITOREI-ARTIKEL
LA PÂTISSERIE
PASTELERÍA

PREPARAZIONE *PREPARATION TOOLS*



PASTICCERIA PASTRY UTENSILS
TAGLIAPASTA INOX - STAINLESS STEEL CUTTERS



Alfabeto
Alphabet

art.	ø cm.	h.	pz/pcs
47301-12	12	2	26



Numeri
Numbers

art.	ø cm.	h.	pz/pcs
47302-10	10	2	10



Animali
Animals

art.	ø cm.	h.	pz/pcs
47303-10	10	2	10



Sagome
Shapes

art.	ø cm.	h.	pz/pcs
47304-06	6,5	2	12
47304-10	10,0	2	12
47304-12	12,0	2	12



Sagome
Shapes

art.	ø cm.	h.	pz/pcs
47305-12	12	2	12



Fiore
Flower

art.	ø cm.	h.	pz/pcs
47306-10	10	3	6



Trio
Trio

art.	ø cm.	h.	pz/pcs
47307-10	10	3	6



Cuore
Heart

art.	ø cm.	h.	pz/pcs
47308-10	10	3	6



Stella
Star

art.	ø cm.	h.	pz/pcs
47310-10	10	3	6



Mezzaluna
Halfmoon

art.	ø cm.	h.	pz/pcs
47312-10	10	3	6



Esagono
Hexagon

art.	ø cm.	h.	pz/pcs
47314-10	10	3	6

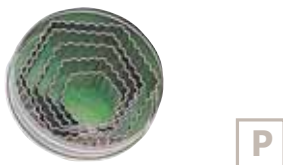

Esagono festonato
Hexagon, fluted

art.	ø cm.	h.	pz/pcs
47315-10	10	3,5	5



Anello
Ring

art.	ø cm.	h.	pz/pcs
47316-10	10	3,0	11
47316-12	12	3,0	14
47316-20	20	2,5	20



Anello festonato
Ring, fluted

art.	ø cm.	h.	pz/pcs
47317-10	10	3,0	11
47317-12	12	3,0	14
47317-20	20	2,5	20



Goccia
Drop

art.	ø cm.	h.	pz/pcs
47321-12	12	3	6



Goccia festonata
Drop, fluted

art.	ø cm.	h.	pz/pcs
47322-12	12,5	3,5	5

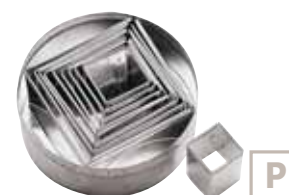

Quadro
Square

art.	ø cm.	h.	pz/pcs
47323-12	12	3	6

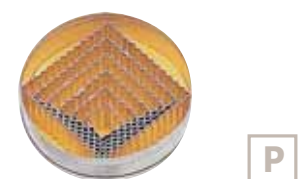

Quadro festonato
Square, fluted

art.	ø cm.	h.	pz/pcs
47324-12	12,5	3,5	6

PASTICCERIA PASTRY UTENSILS



Ovale festonato
Oval fluted

art.	ø cm.	h.	pz/pcs
47325-10	10	3,5	9



Ovale
Oval

art.	ø cm.	h.	pz/pcs
47326-10	10	3,5	9



Frutta
Fruit

art.	ø cm.	h.	pz/pcs
47327-12	12,5	2	12



Animali
Animals

art.	ø cm.	h.	pz/pcs
47328-15	15	2	10



Veicoli
Vehicles

art.	ø cm.	h.	pz/pcs
47331-15	15	2	7



Verdura
Vegetable

art.	ø cm.	h.	pz/pcs
47332-12	12,5	2	12



Natale
Christmas

art.	ø cm.	h.	pz/pcs
47333-15	15	2	7



Pasqua
Easter

art.	ø cm.	h.	pz/pcs
47334-12	12,5	2	6



Stelle
Stars

art.	ø cm.	h.	pz/pcs
47335-12	12,5	2	7



Sagome
Shapes

art.	cm.	h.	pz/pcs
47419-10	20	3,5	10



Tagliapasta geometrici, 42 pz
Set 42 geometric shape cutters

art.	ø
47336-42	6>22



Cerchio liscio, set 3 pz
Round cutter, 3 pcs set

art.	h. cm.	ø
47414-03	3	6-7-8



Cerchio festonato, set 3 pz
Round cutter, fluted 3 pcs set

art.	h. cm.	ø
47415-03	3	6-7-8



Canestrello
Canestrello cutter

art.	cm.	h.
47416-06	6	3



Canestrello
Canestrello cutter

art.	cm.	h.
47417-06	6	3



Ruota tagliapaste
Cutter wheel

art.
47418-00

TAGLIAPASTA INOX P STAINLESS STEEL CUTTERS



NATALE - CHRISTMAS



Omino pan di zenzero
Gingerbread man

art.	dim. cm.	h.
47370-08	6x8	3



Angelo
Angel

art.	dim. cm.	h.
47377-08	7x7	3



Pupazzo di neve
Snowman

art.	dim. cm.	h.
47378-08	4x8	3



Renna
Reindeer

art.	dim. cm.	h.
47379-08	8x7	3



Stella
Star

art.	dim. cm.	h.
47411-08	8x8	3



Stella cometa
Comet

art.	dim. cm.	h.
47412-08	8x4	3



Albero di Natale
Christmas tree

art.	dim. cm.	h.
47413-08	8x8	3



Pino
Pine

art.	dim. cm.	h.
47413-01	6,4x8,1	3

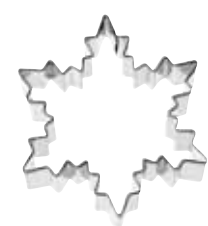

Fiocco di neve
Snowflake

art.	dim. cm.	h.
47411-01	7,4x8,6	3



Fiocco di neve
Snowflake

art.	dim. cm.	h.
47411-02	6,9x7,9	3



Fiocco di neve
Snowflake

art.	dim. cm.	h.
47411-03	8,4x7,7	3



Natale set 6 pz
Christmas, set of 6 pcs.

art.	dim. cm.	h.
47387-01	8x8	3

PASQUA - EASTER



Coniglio
Rabbit

art.	dim. cm.	h.
47372-08	8x4	3



Coniglio
Rabbit

art.	dim. cm.	h.
47402-08	8x5	3



Coniglio
Rabbit

art.	dim. cm.	h.
47402-01	7,1x8,6	3



Coniglio
Rabbit

art.	dim. cm.	h.
47402-02	7,6x7,3	3



Campana
Bell

art.	dim. cm.	h.
47373-08	6x7	3



Agnellino
Lamb

art.	dim. cm.	h.
47376-08	8x7	3



Colomba
Dove

art.	dim. cm.	h.
47382-08	8x7	3



Uovo
Egg

art.	dim. cm.	h.
47373-01	5,6x8,2	3

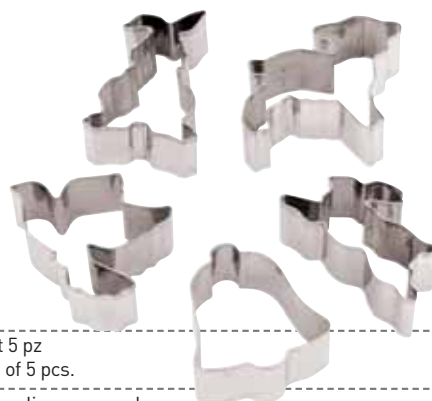

Pasqua set 5 pz
Easter, set of 5 pcs.

art.	dim. cm.	h.
47387-02	8x8	3

HALLOWEEN



Scheletro
Skeleton

art. 47370-08 dim. cm. 6x8 h. 3



Zucca
Pumpkin

art. 47377-09 dim. cm. 8,7x7,8 h. 3



Zucca
Pumpkin

art. 47377-10 dim. cm. 7,9x7,9 h. 3



Mezzaluna
Crescent

art. 47377-01 dim. cm. 6,2x8 h. 3



Gufo
Owl

art. 47377-02 dim. cm. 4,7x8,3 h. 3



Fantasma
Ghost

art. 47377-03 dim. cm. 7,8x8,4 h. 3



Strega
Witch

art. 47377-04 dim. cm. 9,3x9,6 h. 3



Cappello trega
Witch hat

art. 47377-05 dim. cm. 8,5x13,1 h. 3



Strega su scopa
Witch on broom

art. 47377-06 dim. cm. 11,6x11,7 h. 3



Teschio
Skull

art. 47377-07 dim. cm. 7,9x7,9 h. 3

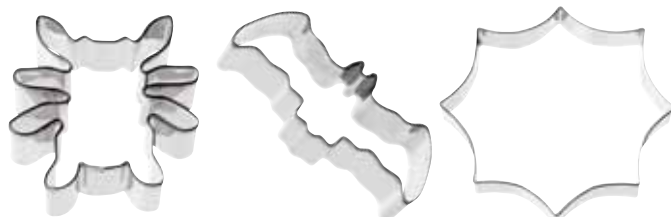

Halloween set 3 pz
Halloween, set of 3 pcs.

art. 47377-11 dim. cm. 11x10,7 h. 3



ANIMALI - ANIMALS



Ape
Honey bee
art. 47382-06 dim. cm. 11,6x7,9 h. 3



Ippopotamo
Hippo
art. 47404-04 dim. cm. 10,9x6,8 h. 3



Coccinella
Ladybug
art. 47404-05 dim. cm. 8,2x8,1 h. 3



Farfalla
Butterfly
art. 47371-08 dim. cm. 8x7 h. 3



Lumaca
Snail
art. 47404-02 dim. cm. 11,1x5,7 h. 3



Rana
Frog
art. 47380-08 dim. cm. 8x8 h. 3



Gallo
Rooster
art. 47383-08 dim. cm. 8x8 h. 3

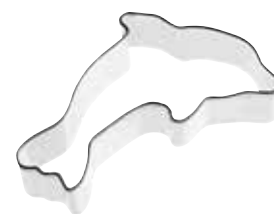

Delfino
Dolphin
art. 47384-01 dim. cm. 4,7x8,8 h. 3



Gabbiano
Seagull
art. 47386-08 dim. cm. 11x6 h. 3



Gatto
Cat
art. 47401-08 dim. cm. 8x8 h. 3



Oca
Goose
art. 47404-08 dim. cm. 8x7 h. 3



Orsetto
Teddy bear
art. 47375-08 dim. cm. 8x8 h. 3



Orsetto
Teddy bear
art. 47375-01 dim. cm. 5,7x8,8 h. 3



Cammello
Camel
art. 47404-01 dim. cm. 9,3x8,6 h. 3



Elefante
Elephant
art. 47404-03 dim. cm. 11,8x6,9 h. 3

VARIE - VARIOUS



Quadrifoglio
Four leaf clover

art.	dim. cm.	h.
47374-08	8x8	3



Fiore
Flower

art.	dim. cm.	h.
47374-02	6,7x7,4	3



Tulipano
Tulip

art.	dim. cm.	h.
47374-01	5,5x8,4	3



Cuore
Heart

art.	dim. cm.	h.
47385-08	8x9	3



Due cuori
Two hearts

art.	dim. cm.	h.
47385-01	9,4x5	3



Cavallo a dondolo
Rocking horse

art.	dim. cm.	h.
47381-08	8x5	3



Fiocco
Bow

art.	dim. cm.	h.
47373-02	5,7x7,8	3



Mela
Apple

art.	dim. cm.	h.
47378-01	7,6x8,4	3



Nave pirata
Pirate ship

art.	dim. cm.	h.
47370-03	7,8x8,4	3



Aereo
Airplane

art.	dim. cm.	h.
47370-02	9,3x8,6	3



Locomotiva
Train

art.	dim. cm.	h.
47370-01	9,9x7	3



Semi carte set 4 pz
Suits of cards, set of 4 pcs

art.	dim. cm.	h.
47378-02	7,5x7,5	3





Numeri, set 9 pz
Numbers, set of 9 pcs

art. cm. h.
47421-09 6,5 2,5



Lettere, set 26 pz
Letters, set of 26 pcs

art. cm. h.
47422-26 6 2,5





Cerchio
Round

art.	cm.	h.	u.pack
47425-01	4	3	6
47425-02	5	3	6
47425-03	6	3	6



Quadro
Square

art.	cm.	h.	u.pack
47425-04	5	3	6
47425-05	6	3	6



Triangolo
Triangle

art.	cm.	h.	u.pack
47425-06	6	3	6



Ovale
Oval

art.	cm.	h.	u.pack
47425-09	7,5x4,5	3	6



Trapezio
Trapeze

art.	cm.	h.	u.pack
47425-08	9x6	3	6



Rettangolo
Rectangle

art.	cm.	h.	u.pack
47425-10	5x3,5	3	6
47425-11	6x5	3	6



Goccia
Drop

art.	cm.	h.	u.pack
47425-26	9	3	6



Esagono
Hexagon

art.	cm.	h.	u.pack
47425-29	5	3	6
47425-30	6	3	6



Cuore
Heart

art.	cm.	h.	u.pack
47425-32	6,5	3	6



Quadro
Square

art.	cm.	h.	u.pack
47426-01	8	4,5	6



Rettangolo
Rectangle

art.	cm.	h.	u.pack
47426-07	12x6	4,5	1



P **TAGLIAPASTA - CUTTERS** **PA+**
plus



Paderno ha sviluppato questa gamma di tagliapasta in materiale composito sotto il marchio Paplus®. Materiale innovativo, non poroso, lavabile in lavastoviglie e sterilizzabile, conforme alle norme europee relative ai materiali in contatto con alimenti. Leggeri e maneggevoli, presa confortevole grazie ai bordi arrotondati. La costruzione unipezzo li rende igienici e facili da pulire. Resistenti e indeformabili dal taglio sempre perfetto. Ottimi anche per preparazioni a caldo in quanto non assorbono calore e quindi non scottano.

Paderno has developed these new pastry cutters made of the composite material branded Paplus®. This material is non-porous, dishwasher safe can be sterilized and meets all requirements of EU hygiene regulations. Light and handy, provide a comfortable grip due to their rounded tops. Hygienic, easy to clean being of a single piece. Long lasting, durable cutting edge, do not lose their original shape. Excellent also for hot preparations, do not absorb heat and therefore do not burn.



Rotondo
Round

art.	ø cm.	h.
12943-03	3	3,5
12943-05	5	3,5
12943-07	7	3,5
12943-08	8	3,5
12943-10	10	3,5
12943-12	12	3,5



Rotondo festonato
Round, fluted

art.	ø cm.	h.
12944-03	3	3,5
12944-05	5	3,5
12944-07	7	3,5
12944-08	8	3,5
12944-10	10	3,5
12944-12	12	3,5



Ovale festonato
Oval, fluted

art.	dim. cm.	h.
12947-02	5,5x3,5	3,5
12947-03	7x4	3,5
12947-04	8,5x5	3,5
12947-05	10x6	3,5
12947-06	11x7	3,5
12947-07	13x5	3,5



Scatola tagliapasta rotondi, 6 pz
Set 6 pcs round pastry cutters

art.
12943-13



Scatola tagliapasta rotondi festonati, 6 pz
Set 6 pcs fluted round pastry cutters

art.
12944-13



Scatola tagliapasta ovali festonati, 6 pz
Set 6 pcs fluted oval pastry cutters

art.
12947-13



Pinzetta decoro, inox
Marzipan nipper, stainless steel
Marzipan-Kneifer, Edelstahl Rostfrei
Pince à gaufrier, inox
Pinza, inox

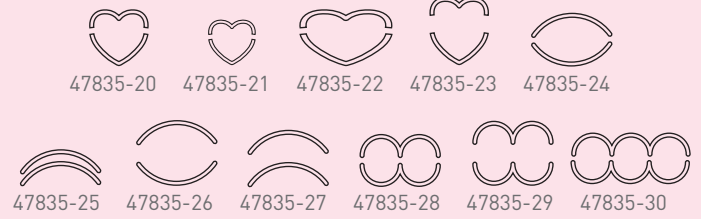

Set 2 Cucchiaini Decorazione
Set 2 Decorating Spoons
Satz 2 Dekoration-Löffel
Set 2 Cuillères Pour Décorer
2 Cucharas Para Decoración



Per decorazioni su piatti con salse, panna, caramello, purea, ecc., ecc. Piccolo per preparazioni dolci, grande per salate. - To make decorations on dishes with sauces, cream, caramel, puree, etc., etc. Small spoon to decorate sweets, a larger one for savory preparations.

art.
47831-02



Set 9 tagliapasta, inox
Set of 9 cutters, s/s
Satz 9 Ausstechformen, Edelstahl Rostfrei
Set 9 découpoirs, inox
Juego 9 cortadores, inox

art.
47837-09

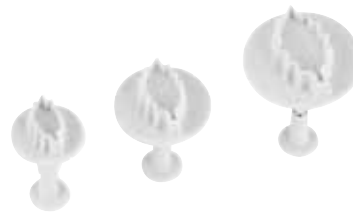

AGRIFOGLIO/HOLLY

Tagliapasta con espulsore, set 3 pz
Dough plunger cutters with extractor
Ausstechformen mit Auswerfer
Emportes-pièces
Cortadore

art. ø cm. h.
47622-04 3,4,5 5



MARGHERITE/DAISY

Tagliapasta con espulsore, set 4 pz
Dough plunger cutters with extractor
Ausstechformen mit Auswerfer
Emportes-pièces
Cortadore

art. ø cm.
47622-26 1,2 - 2 - 2,8 - 3,5



PETUNIE/PETUNIA

Tagliapasta con espulsore, set 3 pz
Dough plunger cutters with extractor
Ausstechformen mit Auswerfer
Emportes-pièces
Cortadores

art. ø cm. h.
47622-01 3,5 5



FIORE/FLOWER

Tagliapasta con espulsore, set 3 pz
Dough plunger cutters with extractor
Ausstechformen mit Auswerfer
Emportes-pièces
Cortadores

art. ø cm. h.
47622-02 2,5 5



**FOGLIA DI ROSA
ROSE LEAF**

Tagliapasta con espulsore, set 3 pz
Dough plunger cutters with extractor
Ausstechformen mit Auswerfer
Emportes-pièces
Cortadores

art. ø cm. h.
47622-03 3,5 5

PASTICCERIA PASTRY UTENSILS

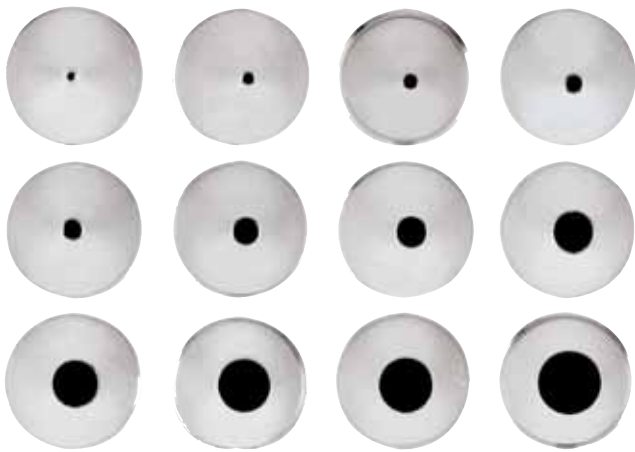

Set 12 bocchette unipezzo, inox
 Set 12 pcs tubes, one piece, s/s
 12 Stk. Tüllen, Edelstahl Rostfrei, aus einem Stück gezogen
 Set 12 pcs douilles monobloc, inox
 Surtido 12 boquillas monobloc, inox

art. base ø cm.
 47357-20 1,7

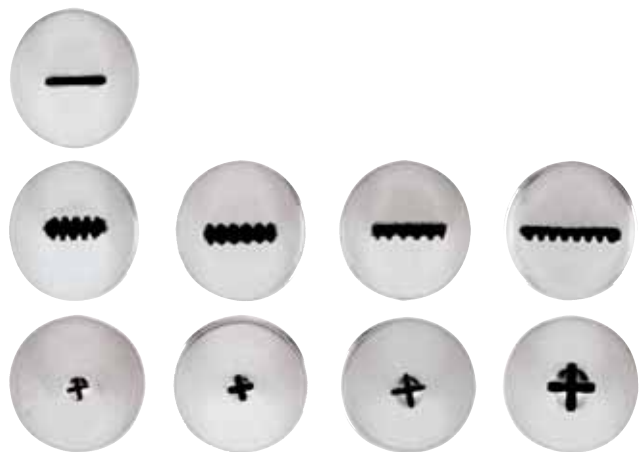

Set 9 bocchette unipezzo, inox
 Set 9 pcs tubes, one piece, s/s
 9 Stk. Tüllen, Edelstahl Rostfrei, aus einem Stück gezogen
 Set 9 pcs douilles monobloc, inox
 Surtido 9 boquillas monobloc, inox

art. base ø cm.
 47357-24 1,7

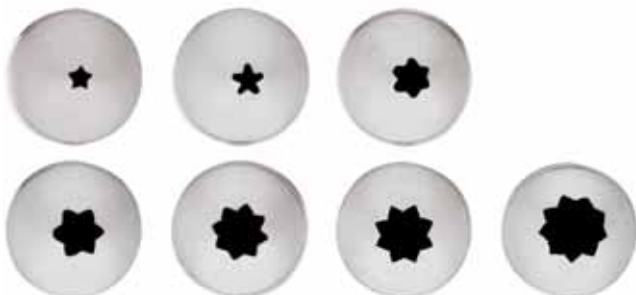

Set 7 bocchette unipezzo, inox
 Set 7 pcs tubes, one piece, s/s
 7 Stk. Tüllen, Edelstahl Rostfrei, aus einem Stück gezogen
 Set 7 pcs douilles monobloc, inox
 Surtido 7 boquillas monobloc, inox

art. base ø cm.
 47357-21 1,7



Set 8 bocchette unipezzo, inox
 Set 8 pcs tubes, one piece, s/s
 8 Stk. Tüllen, Edelstahl Rostfrei, aus einem Stück gezogen
 Set 8 pcs douilles monobloc, inox
 Surtido 8 boquillas monobloc, inox

art. base ø cm.
 47357-22 1,7

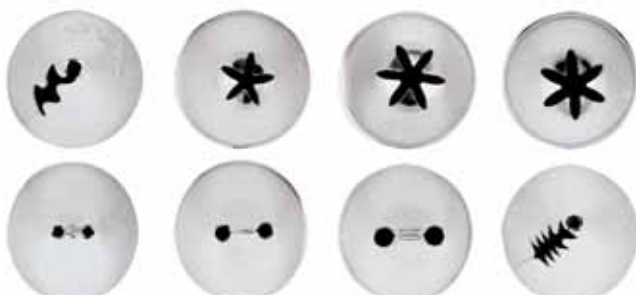

Set 8 bocchette unipezzo, inox
 Set 8 pcs tubes, one piece, s/s
 8 Stk. Tüllen, Edelstahl Rostfrei, aus einem Stück gezogen
 Set 8 pcs douilles monobloc, inox
 Surtido 8 boquillas monobloc, inox

art. base ø cm.
 47357-23 1,7



Set 8 bocchette unipezzo, inox
 Set 8 pcs tubes, one piece, s/s
 8 Stk. Tüllen, Edelstahl Rostfrei, aus einem Stück gezogen
 Set 8 pcs douilles monobloc, inox
 Surtido 8 boquillas monobloc, inox

art. base ø cm.
 47357-25 1,7



Set 8 bocchette unipezzo, inox
 Set 8 pcs tubes, one piece, s/s
 8 Stk. Tüllen, Edelstahl Rostfrei, aus einem Stück gezogen
 Set 8 pcs douilles monobloc, inox
 Surtido 8 boquillas monobloc, inox

art. base ø cm.
 47357-26 1,7



Set 8 bocchette unipezzo, inox
 Set 8 pcs tubes, one piece, s/s
 8 Stk. Tüllen, Edelstahl Rostfrei, aus einem Stück gezogen
 Set 8 pcs douilles monobloc, inox
 Surtido 8 boquillas monobloc, inox

art. base ø cm.
 47357-27 1,7



Set 8 bocchette unipezzo, inox
 Set 8 pcs tubes, one piece, s/s
 8 Stk. Tüllen, Edelstahl Rostfrei, aus einem Stück gezogen
 Set 8 pcs douilles monobloc, inox
 Surtido 8 boquillas monobloc, inox

art. base ø cm.
 47357-28 1,7



Set 8 bocchette unipezzo, inox
 Set 8 pcs tubes, one piece, s/s
 8 Stk. Tüllen, Edelstahl Rostfrei, aus einem Stück gezogen
 Set 8 pcs douilles monobloc, inox
 Surtido 8 boquillas monobloc, inox

art. base ø cm.
 47357-29 1,7



Set 8 bocchette unipezzo, inox
 Set 8 pcs tubes, one piece, s/s
 8 Stk. Tüllen, Edelstahl Rostfrei, aus einem Stück gezogen
 Set 8 pcs douilles monobloc, inox
 Surtido 8 boquillas monobloc, inox

art. base ø cm.
 47357-30 1,7



Set 8 bocchette unipezzo, inox
 Set 8 pcs tubes, one piece, s/s
 8 Stk. Tüllen, Edelstahl Rostfrei, aus einem Stück gezogen
 Set 8 pcs douilles monobloc, inox
 Surtido 8 boquillas monobloc, inox

art. base ø cm.
 47357-31 1,7

PASTICCERIA PASTRY UTENSILS



Set 6 bocchette unipezzo, inox
 Set 6 pcs tubes, one piece, s/s
 6 Stk. Tüllen, Edelstahl Rostfrei, aus einem Stück gezogen
 Set 6 pcs douilles monobloc, inox
 Surtido 6 boquillas monobloc, inox

art. base ø cm.
 47357-06 2,4



Set 6 bocchette unipezzo, inox
 Set 6 pcs tubes, one piece, s/s
 6 Stk. Tüllen, Edelstahl Rostfrei, aus einem Stück gezogen
 Set 6 pcs douilles monobloc, inox
 Surtido 6 boquillas monobloc, inox

art. base ø cm.
 47357-07 2,4



Set 6 bocchette unipezzo, inox
 Set 6 pcs tubes, one piece, s/s
 6 Stk. Tüllen, Edelstahl Rostfrei, aus einem Stück gezogen
 Set 6 pcs douilles monobloc, inox
 Surtido 6 boquillas monobloc, inox

art. base ø cm.
 47357-08 2,4



Set 6 bocchette unipezzo, inox
 Set 6 pcs tubes, one piece, s/s
 6 Stk. Tüllen, Edelstahl Rostfrei, aus einem Stück gezogen
 Set 6 pcs douilles monobloc, inox
 Surtido 6 boquillas monobloc, inox

art. base ø cm.
 47357-09 2,4



Set 6 bocchette unipezzo, inox
 Set 6 pcs tubes, one piece, s/s
 6 Stk. Tüllen, Edelstahl Rostfrei, aus einem Stück gezogen
 Set 6 pcs douilles monobloc, inox
 Surtido 6 boquillas monobloc, inox

art. base ø cm.
 47357-10 2,4



Set 6 bocchette unipezzo, inox
 Set 6 pcs tubes, one piece, s/s
 6 Stk. Tüllen, Edelstahl Rostfrei, aus einem Stück gezogen
 Set 6 pcs douilles monobloc, inox
 Surtido 6 boquillas monobloc, inox

art. base ø cm.
 47357-11 2,4



Set 4 bocchette unipezzo, inox
 Set 4 pcs tubes, one piece, s/s
 4 Stk. Tüllen, Edelstahl Rostfrei, aus einem Stück gezogen
 Set 4 pcs douilles monobloc, inox
 Surtido 4 boquillas monobloc, inox

art. base ø cm.
 47357-01 3



Set 4 bocchette unipezzo, inox
 Set 4 pcs tubes, one piece, s/s
 4 Stk. Tüllen, Edelstahl Rostfrei, aus einem Stück gezogen
 Set 4 pcs douilles monobloc, inox
 Surtido 4 boquillas monobloc, inox

art. base ø cm.
 47357-02 3



Set 7 bocchette unipezzo, inox
 Set 7 pcs tubes, one piece, s/s
 7 Stk. Tüllen, Edelstahl Rostfrei, aus einem Stück gezogen
 Set 7 pcs douilles monobloc, inox
 Surtido 7 boquillas monobloc, inox

art. base ø cm.
 47357-03 3



Set 6 bocchette, inox
 Set 6 pcs tubes, s/s
 6 Stk. Tüllen, Edelstahl Rostfrei
 Set 6 pcs douilles, inox
 Juego 6 boquillas, inox

art. base ø cm.
 47350-01 2,4



Set 6 bocchette, inox
 Set 6 pcs tubes, s/s
 6 Stk. Tüllen, Edelstahl Rostfrei
 Set 6 pcs douilles, inox
 Juego 6 boquillas, inox

art. base ø cm.
 47351-01 2,4



Set 6 bocchette, inox
 Set 6 pcs tubes, s/s
 6 Stk. Tüllen, Edelstahl Rostfrei
 Set 6 pcs douilles, inox
 Juego 6 boquillas, inox

art. base ø cm.
 47352-01 2,4

PASTICCERIA PASTRY UTENSILS

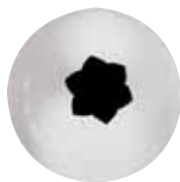

Set 6 bocchette, inox
Set 6 pcs tubes, s/s
6 Stk. Tüllen, Edelstahl Rostfrei
Set 6 pcs douilles, inox
Juego 6 boquillas, inox

Set 6 bocchette, inox
Set 6 pcs tubes, s/s
6 Stk. Tüllen, Edelstahl Rostfrei
Set 6 pcs douilles, inox
Juego 6 boquillas, inox

Set 6 bocchette, inox
Set 6 pcs tubes, s/s
6 Stk. Tüllen, Edelstahl Rostfrei
Set 6 pcs douilles, inox
Juego 6 boquillas, inox

art.	ø mm.
47353-02	2
47353-04	4
47353-06	6
47353-08	8
47353-10	10
47353-12	12
47353-14	14
47353-16	16
47353-18	18
47353-20	20
47353-22	22
47353-24	24

art.	ø mm.
47354-02	2
47354-04	4
47354-06	6
47354-08	8
47354-10	10
47354-12	12
47354-14	14
47354-16	16
47354-18	18

art.	ø mm.
47355-02	2
47355-04	4
47355-06	6
47355-08	8
47355-10	10
47355-12	12



Set 6 bocchette, inox
Set 6 pcs tubes, s/s
6 Stk. Tüllen, Edelstahl Rostfrei
Set 6 pcs douilles, inox
Juego 6 boquillas, inox

Set 6 bocchette, inox
Set 6 pcs tubes, s/s
6 Stk. Tüllen, Edelstahl Rostfrei
Set 6 pcs douilles, inox
Juego 6 boquillas, inox

Set 6 bocchette, inox
Set 6 pcs tubes, s/s
6 Stk. Tüllen, Edelstahl Rostfrei
Set 6 pcs douilles, inox
Juego 6 boquillas, inox

art.	ø mm.
47356-02	2
47356-04	4
47356-06	6
47356-08	8
47356-10	10
47356-12	12
47356-14	14
47356-16	16
47356-18	18

art.	ø mm.	punta/point
47208-01	3,0	5
47208-02	3,0	6
47208-03	3,5	7
47208-04	5,0	8
47208-05	5,0	5
47208-06	5,0	6
47208-07	6,0	7
47208-08	7,0	8
47208-09	7,0	5
47208-10	7,0	6
47208-11	7,0	7
47208-12	9,0	8

art.	ø mm.	punta/point
47208-13	11	5
47208-14	11	6
47208-15	11	7
47208-16	11	8
47208-17	13	5
47208-18	13	6
47208-19	13	7
47208-20	13	8
47208-21	18	5
47208-22	18	6
47208-23	18	7
47208-24	18	8



Adattatore per bocchette, STANDARD
External piping tip adapter
Adapter für Spritztüllen
Adaptateur à douilles
Adaptador para boquillas

Adattatore per bocchette, MEDIUM
External piping tip adapter
Adapter für Spritztüllen
Adaptateur à douilles
Adaptador para boquillas

Adattatore per bocchette, LARGE
External piping tip adapter
Adapter für Spritztüllen
Adaptateur à douilles
Adaptador para boquillas

art.
47212-01

art.
47212-02

art.
47212-03

Pratici adattatori per cambiare facilmente bocchetta. - Practical adapters for an easy nozzle change.

PASTICCERIA PASTRY UTENSILS
PREPARAZIONE PREPARATION TOOLS



Set 6 bocchette, inox
Set 6 pcs tubes, s/s
6 Stk. Tüllen, Edelstahl Rostfrei
Set 6 pcs douilles, inox
Juego 6 boquillas, inox

art.	ø mm.
47207-20	20
47207-25	25
47207-30	30



Bocchetta a imbuto, inox
Bismark tube, s/s
Fülltüllen, Edelstahl Rostfrei
Douille à chou, inox
Boquilla para relleno, inox

art.	ø mm.	l.	u.pack
47127-04	4	90	10
47127-06	6	75	10
47127-08	8	90	10



Cannoli, inox
Cream roll molds, s/s
Rahm- und Cremerollen, Edelstahl
Rouleau à fromage, inox
Rodillos queso, inox

art.	ø mm.	l.	u.pack
47020-15	15	92	10
47020-20	22	142	10
47020-30	10-25	139	10
47020-35	20-25	171	10



Cornetti, inox
Cream horn molds, s/s
Cornetspitze, Edelstahl Rostfrei
Moulet à cornet, inox
Moldes para conos, inox

art.	ø mm.	l.	u.pack
47021-35	34	110	10
47021-45	47	161	10



N

Cornetti, PA 6
Cream horn molds, plastic
Cornetspitze, Kunststoff
Moulet à cornet, plastique
Moldes para conos, plástico

art.	dim. mm.	u.pack
47021-30	30x120	10

Materiale plastico utilizzabile in forno.
Plastic material, oven ready.



Bruschino per bocchette
Pastry tube brush
Tüllen-Bürste
Brosse à douilles
Cepillo para boquillas

art.	u.pack
47200-02	6



Bruschino per bocchette
Pastry tube brush
Tüllen-Bürste
Brosse à douilles
Cepillo para boquillas

art.	u.pack
47200-01	6



Set 38 pz, inox
Set 38 pcs, s/s
38 Stk.- Sortiment, Edelstahl Rostfrei
Set 38 pcs, inox
Surtido 38 boquillas inox

art.
47219-38



Set 55 pz, inox
Set 55 pcs, s/s
55 Stk.- Sortiment, Edelstahl Rostfrei
Set 55 pcs, inox
Surtido 55 boquillas inox

art.
47219-55



Set 29 pz, inox
Set 29 pcs, s/s
29 Stk.- Sortiment, Edelstahl Rostfrei
Set 29 pcs, inox
Surtido 29 boquillas inox

art.
47219-29



P

Kit decoro 8 pezzi
Decorating set 8 pcs
Dekorations-Set, 8-teilig
Set 8 pcs à décorer
Juego 9 piezas para decorar

art.
47120-01
47120-02



Levafiori, inox
Flower lifter, s/s
Rosenheber, Edelstahl Rostfrei
Enlève fleurs, inox
Aparato quita flores, inox

art.	ø mm.	l.	u.pack
47207-40	34	110	4

PASTICCERIA PASTRY UTENSILS



Set 10 chiodi per fiori, inox
 Set 10 flower nails, s/s
 10 Stk. Blumenstempel, Edelstahl
 Set 10 clous à fleurs, inox
 Surtido 10 clavos para flores, inox



art.	ø mm.	art.	ø mm.
47207-01	20	47207-06	36
47207-02	30	47207-08	45
47207-03	35	47207-09	33
47207-04	33	47207-10	40
47207-05	40		



Set bocchette assortite, BPA-Free
 Set of assorted nozzles
 Tüllensortiment
 Douilles assorties
 Surtido boquillas



art.	h. cm.	pz-pcs
47251-00	3-3,5	13

Trasparenti, lavabili in lavastoviglie. 8 bocchette ø mm. 1/2/3/5/7/9/13/15 - 2 adattatori + 2 tappi - 1 bruschino. - *Crystal clear, dishwasher proof.* 8 tubes ø mm. 1/2/3/5/7/9/13/15. 2 adapters + 2 lids - 1 brush.



Set bocchette assortite, BPA-Free
 Set of assorted nozzles
 Tüllensortiment
 Douilles assorties
 Surtido boquillas



art.	h. cm.	pz-pcs
47251-01	3-3,5	13

Trasparenti, lavabili in lavastoviglie. 8 bocchette foro stella ø mm. 4/5/7/9 (6 punte) 7/9/11/13 (8 punte) - 2 adattatori + 2 tappi - 1 bruschino. *Crystal clear, dishwasher proof.* 8 star tubes ø mm. 4/5/7/9 (6 points) 7/9/11/13 (8 points) - 2 adapters + 2 lids - 1 brush.



Set bocchette assortite, BPA-Free
 Set of assorted nozzles
 Tüllensortiment
 Douilles assorties
 Surtido boquillas



art.	h. cm.	pz-pcs
47251-02	3-3,5	13

Trasparenti, lavabili in lavastoviglie. 8 bocchette - 1 bocchetta a imbuto - 2 adattatori + 2 tappi. - *Crystal clear, dishwasher proof.* 8 tubes - 1 bismark tube - 2 adapters + 2 lids.



Set bocchette assortite, BPA-Free
 Set of assorted nozzles
 Tüllensortiment
 Douilles assorties
 Surtido boquillas



art.	h. cm.	pz-pcs
47251-03	3-3,5	13

Trasparenti, lavabili in lavastoviglie. 8 bocchette foro stella ø mm. 4,5/5,5/6/7,5/8/8/9/10 - 2 adattatori + 2 tappi - 1 bruschino. *Crystal clear, dishwasher proof.* 8 star tubes ø mm. 4,5/5,5/6/7,5/8/8/9/10 - 2 adapters + 2 lids - 1 brush.

PASTICCERIA PASTRY UTENSILS
PREPARAZIONE PREPARATION TOOLS



Set 6 bocchette foro tondo, PP
Set of 6 PP plain tube nozzles
6 Stk.-Lochtüllen, PP
6 douilles unies, PP
6 boquillas, PP

art.	pz/pcs	ø mm.
47214-86	6	5-7-9-11-13-15



Set 6 bocchette foro stella, PP
Set of 6 PP star tube nozzles
6 Stk.-Sternfüßen PP
6 douilles cannelées, PP
6 boquillas, PP

art.	pz/pcs	ø mm.
47215-86	6	3-5-7-9-11-13



Set 8 bocchette, PP
Set of 8 assorted PP nozzles
8 Stk.-Tüllensortiment, PP
8 douilles assorties, PP
Surtido 8 boquillas, PP

art.
47216-88



Set 12 bocchette assortite, PP
Set of 12 assorted PP nozzles
12 Stk.-Tüllensortiment, PP
12 douilles assorties, PP
Surtido 12 boquillas, PP

art.	pz/pcs	ø mm.
47618-10	12	2>10
47618-20	12	10>20

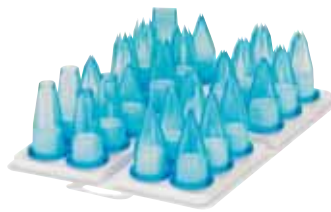

Bocchette assortite, PC
Set of assorted PC nozzles
Tüllensortiment, Polycarbonat
Douilles assorties, polycarbonate
Surtido boquillas, PC

art.	pz/pcs
47250-12	12
47250-24	24



Vaso porta sacchetto, polipropilene
Icing bag holder, PP
Spritzbeutel-Absetzständer, PP
Support à poches, PP
Soporte para mangas, PP

art.	ø cm.	h.
47110-23	19,5	23



Lavare a mano con acqua calda, immergere brevemente in acqua bollente. - Hand wash with hot running water, short dipping into boiling water.

Sacchetto per decorare
Icing bag
Spritzbeutel
Sac à dresser
Mangas para decorar

art.	h. cm	u.pack
47106-28	28	6
47106-34	34	6
47106-40	40	6
47106-46	46	6
47106-50	50	6
47106-55	55	6
47106-60	60	6
47106-65	65	6
47106-70	70	6
47106-75	75	6

Fibra sintetica con rivestimento a strati in plastica impermeabile. - Synthetic fibre with multi-layer water-proof plastic coating.

Sacchetto per decorare
Icing bag
Spritzbeutel
Sac à dresser
Mangas para decorar

art.	h. cm	u.pack
47105-28	28	6
47105-34	34	6
47105-40	40	6
47105-46	46	6
47105-50	50	6
47105-55	55	6
47105-60	60	6
47105-65	65	6
47105-70	70	6
47105-75	75	6

Con punta rinforzata, orlo e gancio. Cotone con rivestimento a strati in plastica impermeabile. - With reinforced tip, seam and hanger. Cotton with multi-layer water-proof plastic coating.

Sacchetto per decorare
Icing bag
Spritzbeutel
Sac à dresser
Mangas para decorar

art.	h. cm	u.pack
47119-30	30	6
47119-35	35	6
47119-40	40	6
47119-45	45	6
47119-50	50	6
47119-60	60	6

Con punta rinforzata, orlo e gancio. Poliuretano con rivestimento in nylon. Saldatura ad alta frequenza. - With reinforced tip, seam and hanger. Polyurethan with nylon coating. High frequency electric seaming.

PASTICCERIA PASTRY UTENSILS



Realizzato in gomma alimentare. Non trasuda, anche quando si utilizzano composti grassi, garantisce grande sensibilità, morbido e maneggevole. Facile da pulire, si può mettere in lavastoviglie. Non assorbe odori. Ottimo grip antiscivolo. Resistente alle sollecitazioni di pressione con composti molto duri (non deforma lateralmente).
Made with food rubber. It does not sweat, even with fat compounds. Extremely soft and handy and perfectly welded in the joints to avoid infiltration of product. Very easy to clean, dishwasher-safe. Perfect antislip grip. High resistance to pressure stress also with hard compounds (it does not warp).



Sacchetti per decorare, monouso, PE
 Disposable icing bags, PE
 Einwegspritzebeutel, PE
 Poches en polyéthylène, jetables
 Mangas desechables

art.	my	h. cm	box px/pcs
47118-30	80	30	100
47118-40	80	40	100
47118-55	80	55	100
47118-65	80	65	100

Sacchetti usa e getta. Ruvido all'esterno per assicurare una salda impugnatura, liscio all'interno per facilitare la fuoriuscita del prodotto.
Disposable icing bags. Rough outside to ensure a firm grip, smooth inside to facilitate the product release.

Sacchetto per decorare
 Icing bag
 Spritzbeutel
 Sac à dresser
 Mangas para decorar

art.	h. cm
47112-34	34
47112-45	45
47112-50	50



Siringa per pasticceria, set 20 pezzi
 Cookie press and icing set 20 pcs
 Gebäckspritze-Satz, 20 Stk.
 Seringue à pâtisserie, jeu 20 pcs
 Jeringuilla pastelería, juego 20 pcs.

art.	ml.
47010-20	250



Per un utilizzo ottimale della siringa suggeriamo la frolla montata. Un composto soffice usato in pasticceria che si utilizza per la preparazione di tutti quei biscotti che per essere realizzati hanno bisogno di sac-à-poche oppure di sparabiscotti - *For a correct use of the syringe we suggest shortbread dough. This soft compound is used in pastry for the preparation of all those cookies made with pastry bags or biscuit maker.*



Sacchetti per decorare, monouso, PE
 Disposable icing bags, PE
 Einwegspritzebeutel, PE
 Poches en polyéthylène, jetables
 Mangas desechables

art.	my	h. cm	l. cm.	box px/pcs
47111-30	90	30	16,0	100
47111-40	90	40	22,0	100
47111-46	90	46	23,0	100
47111-55	90	55	27,5	100

Sacchetto per decorare doppio
 Double pastry bag
 Doppeldressierbeutel
 Sac à dresser, double
 Mangas para decorar, doble

art.	h. cm
47104-34	34
47104-40	40
47104-46	46
47104-50	50



Sac a poche doppio in cotone per l'utilizzo in contemporanea di due diversi ingredienti o aromi. Con cucitura, gancio e punta rinforzata. Incl. 1 bocchetta foro stella, ø 5 mm. - *Double cotton pastry bag for using two different ingredients or flavours at the same time. With seam, hanger and reinforced tip. Incl. 1 star tip, ø 5 mm.*

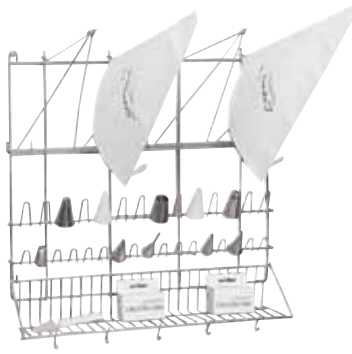

Espositore sacchetti/bocchette, inox
Icing bags & nozzles wall rack, s/s
Spritzbeutel-/ u. Tüllenaufhänger, E. R.
Séchoir à poche et douilles, inox
Secador mangas y boquillas, inox

art.	dim. cm.	h.
47113-03	50x42	50



Espositore per sacchetti, inox
Wall rack for icing bags, s/s
Spritzbeutelauflänger, Edelstahl
Séchoir à poche, inox
Secador cuelga-mangas, inox

art.	dim. cm.	h.
47107-00	50x42	26

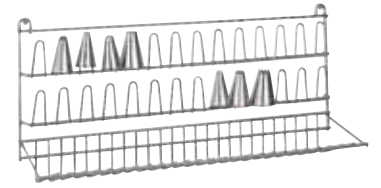

Espositore per bocchette, inox
Wall rack for nozzles, s/s
Tüllenaufhänger, Edelstahl Rostfrei
Séchoir à douilles, inox
Secador boquillas, inox

art.	dim. cm.	h.
47108-00	50x13	24



Pizzi sottotorta
Doilies
Tortenspitzen, Rosendekor
Dentelles décor rose
Blondas

art.	dim. cm.	u. pack
47687-24	18-25	250



Pizzi sottotorta
Doilies
Tortenspitzen, Rosendekor
Dentelles décor rose
Blondas

art.	ø cm.	u. pack
47686-10	6-10	250
47686-12	6,5-12	250
47686-14	8-14	250
47686-17	9,5-16,5	250
47686-22	12,5-22	100
47686-24	15-24	100



Pizzi sottotorta
Doilies
Tortenspitzen, Rosendekor
Dentelles décor rose
Blondas

art.	ø cm.	u. pack
47686-26	16-27	100
47686-30	19-30	100
47686-33	20-32	100
47686-36	22-36	100
47686-42	25-42	100



Girello, alluminio
Cake plate, swivel base, aluminum
Tortenplatte mit Drehfuß, aluminium
Guéridon plaque tournante, alu
Pedestal giratorio para tartas, aluminio

art.	ø cm.	h.
47101-30	30	10



Alzata torta, base girevole, alluminio
Cake plate, swivel base, aluminum
Tortenplatte mit Drehfuß, aluminium
Guéridon plaque tournante, alu
Pedestal giratorio para tartas, aluminio

art.	dim. cm.	h.
47101-40	30x40	10



Campana, PC
Protection cover, PC
Abdeckhauben, PC
Cloche, PC
Tapa, PC

art.	ø cm.	h.
47103-30	30	12



Girello per decorazione torte
Cake-plate, revolving disc
Tortendrehscheibe
Guéridon, plaque tournante
Pedestal giratorio para tartas

art.	ø cm.	h.
47103-32	32	10



Pala per torte, inox
Cake peel, s/s
Tortenschaufel, Edelstahl Rostfrei
Pelle à tarte, inox
Pala para tartas, inox

art.	ø cm.
47094-30	30



Griglia di collaggio, inox
Draining rack, s/s
überziehgitter, Edelstahl Rostfrei
Grille à glacer, inox
Rejilla, inox

art.	dim. cm.	h.
47097-60	59x39	2,6

PASTICCERIA PASTRY UTENSILS

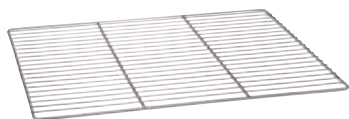

Griglia in filo, inox
Wire grid, s/s
Rost, Edelstahl Rostfrei
Grille, inox
Rejilla, inox

art. dim. cm.
44430-60 60x40

ø quadro/frame 5 mm.
Nr. traverse/cross-bars 2
Nr. fili/wires 29
ø fili/wires 2 mm.

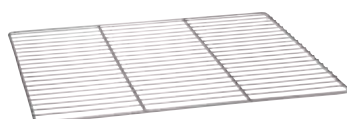

Griglia in filo, inox
Wire grid, s/s
Rost, Edelstahl Rostfrei
Grille, inox
Rejilla, inox

art. dim. cm.
44430-61 60x40

ø quadro/frame 6 mm.
Nr. traverse/cross-bars 2
Nr. fili/wires 24
ø fili/wires 3 mm.



Griglia di colaggio, inox
Draining rack, s/s
überziehgitter, Edelstahl Rostfrei
Grille à glacer, inox
Rejilla, inox

art. dim. cm. h.
44431-46 46x30,5 2,5
44431-60 60x40 2,5



Teglia forata, alluminio
Perforated aluminum baking tray
Aluminium Backbleche, gelocht
Plaque à cuisson perforée, aluminium
Placa pastelería perforada, aluminio

art.	dim. cm.	GN
41756-30	30x40	
41756-32	32,5x53	1/1
41756-53	53x65	2/1
41756-60	60x40	

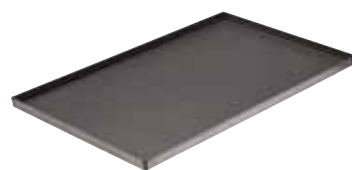

Teglia rettangolare, antiaderente
Baking sheet, non stick coated
Blech mit Antihafbeschichtung
Plaque avec revêtement anti-adhésif
Placa pastelería anti-adherente

art.	dim. cm.	h.
41747-60	60x40	2



Teglia rettangolare, alluminata
Baking sheet, alusteel
Blech mit Aluminiumüberzug
Plaque rectangulaire, tôle aluminitée
Placa pastelería, aluminio

art.	dim. cm.	h.
41746-60	60x40	2

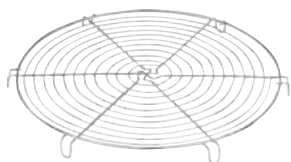

Griglia di raffreddamento, cromata
Cake cooling tray, chromed
Tortengitter, verchromt
Grille ronde à tourte, chromé
Rejilla para tortas, cromada

art.	ø cm.
47098-18	18,5
47098-22	22,0
47098-26	26,0
47098-30	30,0



Teglia forata, siliconata
Perforated tray, silicone coated
Backbleche, gelocht, Silikonbeschichtet
Plaque perforée, revêtement silicone
Placa perforada anti-adherente

art.	dim. cm.	GN
41753-30	30x40	
41753-32	32,5x53	1/1
41753-53	53x65	2/1
41753-60	60x40	



Teglia, alluminio
Aluminum baking tray
Aluminium Backbleche
Plaque à cuisson, aluminium
Placa pastelería, aluminio

art.	dim. cm.	GN
41744-32	32,5x53	1/1
41744-53	53x65	2/1
41744-60	60x40	



Teglia, siliconata
Tray, silicone coated
Backbleche, Silikonbeschichtet
Plaque, revêtement silicone
Placa anti-adherente siliconada

art.	dim. cm.	GN
41743-32	32,5x53	1/1
41743-53	53x65	2/1
41743-60	60x40	



Teglia rettangolare, alluminata
Baking sheet, alusteel
Blech mit Aluminiumüberzug
Plaque, tôle aluminitée
Placa pastelería, aluminio

art.	dim. cm.	h.
41751-30	30x23	3
41751-35	35x28	3
41751-40	40x30	3
41751-50	50x35	3
41751-60	60x40	3
41751-65	65x45	3



Bacinella carré, ferro blu
Blue steel bread mold
Brotform, Blaublech
Pain de mie, tôle bleue
Molde, hierro

art.	dim. cm.	h.
41748-20	20x10	10
41748-30	30x10	10
41748-35	35x10	10
41748-40	40x10	10
41748-50	50x10	10



Bacinella carré, alluminata
Bread mold, alusteel
Brotform mit Aluminiumüberzug
Pain de mie, tôle aluminitée
Molde, acero aluminizado

art.	dim. cm.	h.
41750-20	20x10	10
41750-30	30x10	10
41750-40	35x10	10
41750-41	40x10	10
41750-50	50x10	10



Dosa creme, inox
Cream dispenser, s/s
Dosierer, Edelstahl Rostfrei
Doseur à crème, inox
Dosificador, inox

art.	dim. cm.	h.	GN
47612-01	20x16	23	1/6



Imbuto colatore, inox
Confectionery funnel, stainless steel
Likör- u. Fondanttrichter, Edelstahl Rostfrei
Entonnoir à fondant, inox
Embudo colador, inox

art.	ø cm.	h.	lt.
47800-22	22	21	2

Con 3 bocchette ø 2, 4, 6 mm.
Supplied with 3 nozzles ø 2, 4, 6 mm.



Imbuto colatore, inox
Confectionery funnel, stainless steel
Likör- u. Fondanttrichter, Edelstahl Rostfrei
Entonnoir à fondant, inox
Embudo colador, inox

art.	lt.
47801-10	0,9

Con manico e base di sostegno in plastica, include 2 bocchette da ø 2 e 4 mm. - Plastic handle and base, includes 2 tubes ø 2 and 4 mm.



Dosatrice per creme
Cream injector
Gebäkfüllmaschine
Entonnoir à crème
Dosificador de porciones

art.	dim. cm.	lt.
47694-03	44x25	3

Corpo macchina in alluminio pressofuso. Imbuto, cilindro, pistone, iniettore, leva e nasello di spinta in acciaio inox. Pistone: ø 24 mm. Dosi: 1-12 gr. - Cast aluminum body. Funnel, cylinder, piston, injector, lever and thrust rib in s/s. Piston: ø 24 mm. Doses: 1-12 gr.



Caramellizzatore
Caramelising rod
Caramelisier-Eisen
Fer à caraméliser
Quemador

art.	ø cm.
47846-10	10,5



Temperatrice
Tempering unit
Temperierungsmaschine
Tempereuse
Unidad temperator

art.	dim. cm	h.	lt.	V
47698-03	41x23	13,5	3,6	220
47698-06	40x33	13,5	6,0	220

Realizzata in materiale plastico termoresistente, vasca e coperchio in acciaio inox. - Thermoresistant plastic material, basin and cover stainless steel.



Pistola elettrica
Electric spray gun
Sprühpistole, elektrisch
Pistolet électrique
Pistola eléctrica

art.	g./min	ml.	bar	Kg.
47848-07	280	700	0-160	1,1

Per burro, oli, cera, gelé, marmellata, cioccolata, agenti distaccanti ed emulsionanti alimentari. Per liquidi max. 65°C - Potenza 60 W. - For butter, oil, fat, wax, jelly, jam, chocolate, releasing agent and emulsion for foodstuffs conveyor. Usable for liquids max. 65 °C - Power: 60 W.



Compressore per penna aerografa
Airbrush compressor
Airbrush Kompressor
Compresseur
Compresor

art.	cap.	dim. cm	V	W
47844-06	6 bar	16x30x23	230	200



Penna aerografa, doppia azione
Airbrush, double action
Airbrush-Pistole, doppelt
Aérographe, dual action
Equipo aerógrafo, doble acción

art.	cap.	foro/nozzle
47844-02	7 cm ³	0,3 mm
47844-01	supporto/stand/Gestell	



Lira per pan di Spagna, 3 fili
Cake slicer, 3 cutting wires
Tortendrahtschneider, 3
Lyre à genoise, 3 lames
Cortador de pasteles, 3

art.	ø cm.	h. mm.
47031-46	46	10→90



Lampada per zucchero
Sugar lamp
Zuckerlampe
Lampe à sucre
Lámpara para azúcar



art.	dim. cm.	h.	Kg.
47840-11	61x41	50	6,4



Struttura e piano di lavoro in acciaio inox. Lampada infrarossi con 3 potenze selezionabili, 500-1000-1500W. Incl. cavo di alimentazione.
Working plan and structure in stainless steel. Infrared lamp, 3 selection powers 500-1000-1500W. Cable included.

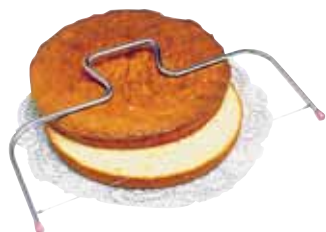

Lira per pan di Spagna
Cake slicer
Tortendrahtschneider
Lyre à genoise
Cortador de pasteles

art.	ø cm.	h. mm.
47031-44	30	20→60

Acciaio cromato. - Chromed steel.



Provetta per pesa sciroppo
Syrup density meter test tube
Sirup-Hydrometer-Becher
Eprouvette pèse-sirop
Probeta aerómetro

art.	ø cm.	h.	ml.
49703-01	3	25	100

Graduata, plastica alimentare, sterilizzabile fino a 120°C. - Graduated, plastic, can be sterilized up to 120°C.



Pesa sciroppo (densimetro)
Syrup density meter
Sirup-Hydrometer
Pèse-sirop
Aerómetro

art.	l. cm.	gr./l.
49703-00	16	1100-1400



Pompetta con terminale in rame
Sugar bulb
Blaszuckerspritze
Poire à sucre soufflé
Pera para azúcar soplado

art.
47838-00



Reggi caramellometro
Sugar thermometer holder
Zuckerthermometer-Träger
Support pour thermomètre à sucre
Soporte para termometro azúcar

art. h. cm.
47842-00 32



Termometro per zucchero, inox
Sugar thermometer, stainless steel
Zuckerthermometer, Edelstahl Rostfrei
Thermomètre à sucre, inox
Termometro para azúcar, inox

art. scala range
47843-00 1°C +80+200°C



Stendipasta, ABS
Smoother
Teig-Glätter
Lisser-pâte
Espátula para alisar

art. dim. cm.
47627-01 16x8



Spatola per biscuit
Biscuit spatula
Biscuit-Spachtel
Spatule à biscuit
Espátula para biscuit

art. l. cm.
47626-55 55,5



Riga
Ruler
Lineal
Règle
Regla

art. l. cm.
47033-50 60

Con 5 divisioni da 12 cm e 7 da 8 cm.
With 5 divisions of cm 12 each and 7 divisions of cm 8 each.



Spatola angolare
Angular spatula
Winkelpalette
Spatule angulaire
Espátula

art. l. cm.
12909-12 12
12909-23 23



Coltello per marzapane, poliammide
Almont past knife, PA
Marzipan-Messer, PA
Couteau à pâte d'amande, PA
Cuchillo, PA

art. l. cm.
47630-28 16,5



Set 15 pezzi per marzapane, PP
Marzipan set, 15 pcs, PP
Marzipan-Satz, 15 Stk., PP
Set 15 outils à pâte d'amandes, PP
Juego 15 piezas, PP

art.
47631-12



Set 10 forchettine pralineria, inox
Set of 10 pcs dipping forks, s/s
Pralinen Gabelchen, 10-Stk., Edelstahl
Jeu de 10 ébauchoirs, inox
Juego 10 tenedores, inox

art.
47833-10



Set 4 forchettine pralineria, inox
Set of 4 pcs dipping forks, s/s
Pralinen Gabelchen, 4-Stk., Edelstahl
Jeu de 4 ébauchoirs, inox
Juego 4 tenedores, inox

art.
47833-04



Set 8 pezzi per marzapane, plastica
Plastic marzipan set, 8 pcs
Marzipan-Satz, 8 Stk.
Set 8 outils en plastique à pâte d'amandes
Juego 8 piezas, plástico

art.
47631-08

PASTICCERIA PASTRY UTENSILS



Chitarra mini
Mini guitar
Praliné-Schneideapparat
Appareil à couper les pralinés
Cortador para pasteles

art. dim. cm.
47692-03 24x24

Mini chitarra per ganache con base in plastica dimensione utile 24x24 cm e telai in acciaio. Include un telaio da 22 mm, un piatto in acciaio, una spatola in plastica ed alcuni accessori per la manutenzione. Adatta a piccole produzioni è ideale per scuole, ristoranti, gelaterie, piccole cioccolaterie. Può essere facilmente posizionata in piccoli spazi e utilizzata solo all'occorrenza. Non usare per torte congelate, tavolette di cioccolato, impasti duri in genere.

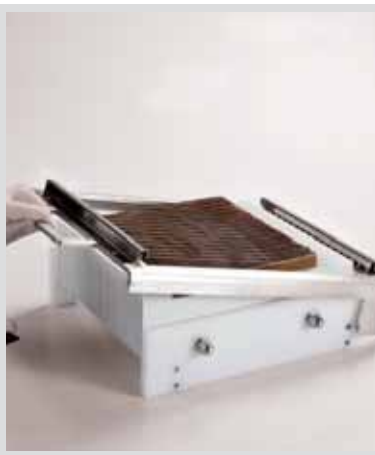

Mini guitar for ganaches with plastic base usable size 24x24 cm and steel frames. Includes a frame of 22 mm, a steel plate, a plastic spatula and some accessories for maintenance. Suitable for small-scale production, is ideal for schools, restaurants, pubs, small chocolate shops. It can be easily placed in small spaces and used only where appropriate. Do not use for frozen pies, chocolate bars or generally hard paste.



Base per ganache + 4 telai
Base for ganache and 4 frames
Basis und 4 Rahmen für Ganache
Base et 4 cadres à ganache
Base y 4 cuadros para ganache

art. dim. cm. h.
47693-00 39x45 13

Il kit per la produzione di ganaches include 2 telai da 3 mm, 2 telai da 5 mm, una spatola e la base in teflon. Misura ganache 24x24 cm. - The kit includes 2 frames of 3 mm, 2 frames of 5 mm, a spatula and the Teflon base. Ganache's size 24x24 cm.

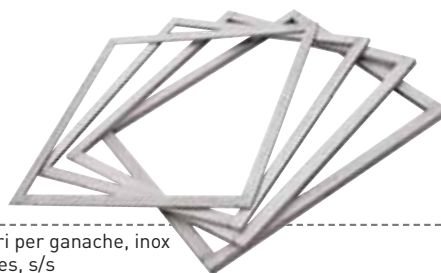

Quadri per ganache, inox
Frames, s/s
Rahmen, Edelstahl Rostfrei
Cadres, inox
Cuadros, inox

art. dim. cm. h.
47693-03 40x40 0,3
47693-05 40x40 0,5
47693-10 40x40 1,0
47693-15 40x40 1,5



Chitarra
Guitar
Praliné-Schneideapparat
Appareil à couper les pralinés
Cortador para pasteles

art. dim. cm. h.
47692-01 39x45 13

Completa di 3 telai da 22,5 - 30 e 45 mm, ideale per tagliare impasti morbidi. - Equipped with 3 cutting frames of 22,5 - 30 and 45 mm, ideal to cut soft products.



Chitarra doppia
Double guitar
Praliné-Schneideapparat
Appareil à couper les pralinés
Cortador para pasteles

art. dim. cm. h.
47692-02 39x45 13h

Completa di 4 telai da 22,5 - 30 - 45 e 30 mm, ideale per tagliare impasti morbidi. - Equipped with 4 cutting frames of 22,5 - 30 - 45 and 30 mm, ideal to cut soft products.



Tagliapasta estensibile, inox
Expanding pastry cutter, s/s
Teigschneider, Edelstahl Rostfrei
Rouleau extensible, inox
Cortapastas extensible, inox

art.	Ø cm.	l.
47820-05	5,5	24
47820-07	5,5	24



Tagliapasta estensibile, inox
Expanding pastry cutter, s/s
Teigschneider, Edelstahl Rostfrei
Rouleau extensible, inox
Cortapastas extensible, inox

art.	Ø cm.	l.
47821-05	5,5	24
47821-07	5,5	24



Tagliapasta estensibile, inox
Expanding pastry cutter, s/s
Teigschneider, Edelstahl Rostfrei
Rouleau extensible, inox
Cortapastas extensible, inox

art.	Ø cm.	l.
47822-05	5,5	28
47822-07	5,5	28

Strisce da 10 a 125 mm. - For pastry stripes 10-125 mm wide.



Tagliapasta estensibile, inox
Expanding pastry cutter, s/s
Teigschneider, Edelstahl Rostfrei
Rouleau extensible, inox
Cortapastas extensible, inox

art.	Ø cm.
47830-05	9,5
47830-07	9,5

Strisce da 10 a 125 mm.
For pastry stripes 10-125 mm wide.



Rotella taglia pasta liscia, inox
Pastry wheel, plain, s/s
Teigrädchen, glatt, Edelstahl Rostfrei
Roulette à pâte lisse, inox
Ruleta cortapasta, inox

art.	Ø cm.	l.
18325-01	5,5	18



Rotella taglia pasta ondulata, inox
Pastry wheel, fluted, s/s
Teigrädchen, gewellt, Edelstahl Rostfrei
Roulette à pâte cannelée, inox
Ruleta cortapasta acanalada, inox

art.	Ø cm.	l.
18325-02	5,5	18



Rotella taglia pasta lama doppia, inox
Double pastry wheel, s/s
Teigrädchen, glatt u. gewellt, Edelstahl
Roulette à pâte double, inox
Ruleta cortapasta doble, inox

art.	Ø cm.	l.
18325-03	5,5	18



Rullo buca sfoglia, POM
Spiked roller, POM
Stipprolle, POM
Pique-pâte, POM
Rodillo, POM

art.	l. cm.
47024-06	6,0
47024-10	11,5



Rullo per losanghe, POM
Cutting roller, POM
Rollmesser, POM
Rouleau à losanges, POM
Rodillo a rombos, POM

art.	l. cm.
47025-06	6,0
47025-10	11,5



Rullo tagliapasta, POM
Cutting roller, POM
Rollmesser, POM
Rouleau à lamelles, POM
Rodillo, POM

art.	l. cm.
47026-06	6,0



Rullo buca sfoglia, inox
Spiked roller, s/s
Stipprolle, Edelstahl Rostfrei
Pique-pâte, inox
Rodillo, inox

art.	l. cm.
47028-12	12



Rullo per losanghe, inox
Cutting roller, s/s
Rollmesser, Edelstahl Rostfrei
Rouleau à losanges, inox
Rodillo a rombos, inox

art.	l. cm.
47029-12	12



Taglia croissants, inox
Croissant cutter, s/s
Dreieckschneidewalze, Edelstahl
Coupe-croissants, inox
Cortador para croissants, inox



art.	dim. cm.	
47027-11	18x20	
47027-12	18x14	
47027-13	11x15	
47027-14	9,7x21	
47027-15	18x20	2x
47027-16	18x20	3x

Manici in polipropilene.
Polypropylene handles.

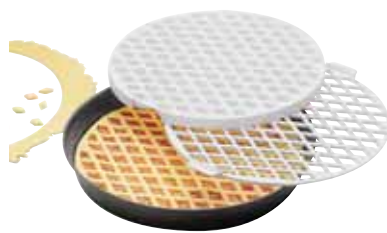

Stampo decora crostate, PS
Stencil for grating pastry, PS
Gitterstempel, PS
Empreinte pour grille de pâte, PS
Molde tortas, PS

art.	Ø cm.
47030-30	30



Stampo per tronco, plastica
Log mold, plastic
Kastenform, Kunststoff
Gouttière, plastique
Molde, plástico

art.	Ø cm.	h.	
47659-01	48x6,5	7	
47659-02	48x6,5	7	
47659-03	48x6,5	7	
47659-04	48x5,0	4	



Segnaporzioni per torte, PP
Cake marker, PP
Tortenteiler, PP
Diviseur à tarte, double, PP
Marcador de tartas, PP

art.	Ø cm.	pz/pcs
47032-10	26,5	10
47032-20	26,5	20



Segnaporzioni per torte, doppio, PP
Cake marker, double-sided, PP
Tortenteiler, doppelseitig, PP
Diviseur à tarte, double, PP
Marcador de tartas, doble, PP

art.	Ø cm.	pz/pcs
47033-08	18,0	8-12
47033-12	26,5	12-18
47033-14	26,5	14-18



Rullo antiaderente
Rolling pin, non-stick coated
Rollwalze mit Antihafbeschichtung
Rouleau avec revêtement anti-adhésif
Rodillo amasador anti-adherente

art.	Ø cm.	l.
47035-40	5,5	20
47035-48	6,5	25



Rullo in legno
Wooden rolling pin
Rollhölzer
Rouleau en bois
Rodillo amasador, madera

art.	Ø cm.	l.
47036-30	9	30
47036-35	9	35
47036-40	9	40
47036-45	9	45
47036-50	9	50
47036-60	9	60



Rullo in legno
Wooden rolling pin
Rollhölzer
Rouleau en bois
Rodillo amasador, madera

art.	Ø cm.	l.
47038-50	9	50
47038-60	7	60

PASTICCERIA PASTRY UTENSILS
PREPARAZIONE PREPARATION TOOLS



Rullo in polietilene
Rolling pin, PE
Rollwalze, PE
Rouleau, PE
Rodillo amasador, PE

art.	Ø cm.	l.	kg.
47037-30	8,0	30	1,7
47037-40	7,5	40	2,2



Rullo tagliapasta, PE
Rolling dough cutter, PE
Rollholzer, PE
Rouleau coupe-bandes, PE
Rodillo cortador, PE

art.	l. cm.	taglio/cut mm.
47039-05	19	5
47039-10	19	10



Rullo tagliapasta, PE
Rolling dough cutter, PE
Rollholzer, PE
Rouleau coupe-bandes, PE
Rodillo cortador, PE

art.	l. cm.	taglio/cut mm.
47039-15	19	15



Rullo, PE
Rolling pin, PE
Rollwalze, PE
Rouleau, PE
Rodillo amasador, PE

art.	Ø cm.	l.
47034-23	2,5	23
47034-51	5,0	50



Rullo in legno
Wooden rolling pin
Rollhölzer
Rouleau en bois
Rodillo amasador, madera

art.	Ø cm.	l.
47034-52	5	50



Rullo, inox
Rolling pin, s/s
Rollwalze, Edelstahl Rostfrei
Rouleau, inox
Rodillo amasador, inox

art.	Ø cm.	l.
47034-50	5	50



Pennello per alimenti
Pastry brush
Kuchenpinsel
Pinceaux à pâtissier
Pincel

art.	l. cm.	u. pack
47642-30	3	6
47642-40	4	6
47642-50	5	6
47642-60	6	6
47642-70	7	6



Pennello per alimenti
Pastry brush
Kuchenpinsel
Pinceaux à pâtissier
Pincel

art.	l. cm.	u. pack
47643-30	3	6
47643-40	4	6
47643-50	5	6
47643-60	6	6
47643-70	7	6

Manico plastica, ghiera inox. - Plastic handle, stainless steel ferrule.



Pennello per alimenti
Pastry brush
Kuchenpinsel
Pinceaux à pâtissier
Pincel

art.	Ø cm.	u. pack
47644-15	1,5	6

Manico e ghiera plastica.
Plastic handle and ferrule.



Pennello per alimenti, PA
Pastry brush, PA
Kuchenpinsel, PA
Pinceaux à pâtissier, PA
Pincel, PA

art.	l. cm.	u. pack
47645-40	4,0	6
47645-60	6,0	6
47645-75	7,5	6

Setole naturali. - Natural bristles.



Pennello per alimenti, PA
Pastry brush, PA
Kuchenpinsel, PA
Pinceaux à pâtissier, PA
Pincel, PA

art.	l. cm.	u. pack
47646-40	4,0	6
47646-60	6,0	6
47646-75	7,5	6

Setole in poliestere. - Polyester bristles.



Raschietti, PP
Dough scrapers, PP
Teigschaber, PP
Raclettes, PP
Rasquetas, PP

art. dim. mm. u.pack
47621-01 216x128 10



Raschietti, PP
Dough scrapers, PP
Teigschaber, PP
Raclettes, PP
Rasquetas, PP

art. dim. mm. u.pack
47621-02 120x86 10



Raschietti, PP
Dough scrapers, PP
Teigschaber, PP
Raclettes, PP
Rasquetas, PP

art. dim. mm. u.pack
47621-03 120x88 10



Raschietti, PP
Dough scrapers, PP
Teigschaber, PP
Raclettes, PP
Rasquetas, PP

art. dim. mm. u.pack
47621-04 121x81 10



Raschietti, PP
Dough scrapers, PP
Teigschaber, PP
Raclettes, PP
Rasquetas, PP

art. dim. mm. u.pack
47621-05 148x99 10



Pettine decoratore, PP
Decorating comb, PP
Dekorationskamm, PP
Peigne à decor, PP
Peine decorador , PP

art. dim. mm. u.pack
47621-06 145x99 10



Pettine decoratore, PP
Decorating comb, PP
Dekorationskamm, PP
Peigne à decor, PP
Peine decorador , PP

art. dim. mm. u.pack
47621-07 110x80 10



Pettine decoratore, PP
Decorating comb, PP
Dekorationskamm, PP
Peigne à decor, PP
Peine decorador , PP

art. dim. mm. u.pack
47621-08 216x128 10



Set 3 pettini decoratori, inox
Set 3 decorating combs, s/s
Dekorationskamm, 3 Stk, Edelstahl
Set 3 peignes à decor, inox
Conjunto 3 peines decoradores , inox

art. dim. cm.
47625-03 10x10



Spargi zucchero, inox
Sugar dredger, stainless steel
Zuckerstreuer, Edelstahl Rostfrei
Glacière à sucre, inox
Dosificador para azúcar, inox

art. Ø cm. h.
47022-12 7 12



Bottiglia per bagne
Bottle for rum spraying
Flasche zum Anfeuchten
Bouteille à puncher
Botella para bañar

art. lt. cm. h.
47679-10 1 10x5,6 27,5



Setaccio farina, inox
Flour sifter, s/s
Einhand-Drücksied, Edestahl Rostfrei
Tamiseur farine, inox
Cedazos, inox

art. Ø cm. h. gr.
42607-05 12 13 500



Setaccio per zucchero a velo
Icing sugar sieve
Sieb für Puderzucker
Tamis à sucre glace
Cedazos

art. Ø cm. h.
47614-25 25,5 7



Setaccio rete farina
Sieve for flour
Sieb für Mehl
Tamis pour farine
Cedazos

art. Ø cm. h.
47615-25 25,5 7



Spazzola per farina
Flour brush
Mehlbürste
Brosse à pétrin
Cepillo para harina

art. l.cm.
42614-21 30

Setole di cavallo. - Horse hair.

PASTICCERIA PASTRY UTENSILS
PREPARAZIONE PREPARATION TOOLS



Vassoio pasticceria, inox
Pastry tray, s/s
Auslegeplatte, Edelstahl Rostfrei
Plat patissier, inox
Bandeja pastelería, inox

art.	dim. cm.	h.
47075-20	20x16	1
47075-30	30x21	1
47075-45	45x34	1



Vassoio vetrina, alluminio
Display plate, aluminum
Auslegeplatte, Aluminium
Plateau pour présentation, alu
Bandeja pastelería, aluminio

art.	dim. cm.	h.
47070-37	37,5x24,5	1
47070-48	48x31	1
47070-60	60x40	1



Vassoio espositore, inox
Tray, stainless steel
Auslegeplatte, Edelstahl Rostfrei
Plateau, inox
Bandeja pastelería, inox

art.	dim. cm.	h.
42533-23	23x16,5	0,5
42533-26	26x19,5	0,5
42533-31	31x24	0,5
42533-36	36x28,5	0,5
42533-40	40x32,5	0,5



Carta da forno siliconata
Baking paper, siliconized
Backtrennfolie, silikonisiert
Feuille de cuisson, siliconée
Papel de horno siliconado

art.	dim. cm.	GN	u.pack
47682-53	53x32,5	1/1	500
47682-60	60x40		500

Pergamena artificiale, sbiancata, g/m²: 41,0, siliconata fronte/retro, riutilizzabile, idonea per tutti i tipi di pasta. - *Artificial parchment, bleached, g/m²: 41,0, both sides siliconized, reusable, for all kinds of dough.*



Carta da forno, rivestimento PTFE
Baking paper, PTFE coated
Backtrennfolie, PTFE-beschichtet
Feuille de cuisson, revêtement PTFE
Papel de horno anti-adherente

art.	dim. cm.	u. pack
47681-60	60x40	10

Tessuto in fibra di vetro rivestito in PTFE, resistente alla trazione, antiaderente, riutilizzabile più di 500 volte. Asciugare dopo l'uso. - *PTFE coated tissue on both sides, can be used up to 500 times, tear-proof. Carefully dry after use.*



Tappeto silicone
Silicone baking sheet
Silikonbackfolie
Tapis cuisson en silicone
Tela de cocción silicona

art.	dim. cm.	GN
47689-53	53x32,5	1/1
47689-60	60x40	



Acetato in fogli
Acetate sheets
Acetat Band-Blätter
Feuilles en acétate
Hojas de acetato



art.	my	dim. cm.	u.pack
47131-30	90	30x30	50
47131-60	90	60x40	50



Nastro acetato in rotolo
Acetate roll
Acetat Bandrolle
Rouleau en acétate
Rollo de cinta de acetato



art.	h. mm	my	mt.
47130-25	25	90	305
47130-30	30	90	305
47130-35	35	90	305
47130-40	40	90	305
47130-45	45	90	305
47130-50	50	90	305
47130-55	55	90	305
47130-60	60	90	305



Noccioli di cottura in ceramica
Baking beans, ceramic
Backkerne, Keramik
Noyaux de cuisson, céramique
Núcleos de cocción, cerámica

art.	kg.
47011-01	1



GUANTI DA FORNO
Oven mitts
PAGINA - Page: 203

PASTICCERIA PASTRY UTENSILS



SILPAT®

Supporto antiaderente ideale per la cottura di tutte le viennoiseries (cornetti, brioches e simili) e tutti i tipi di pasticceria da panetteria cotti in teglie. Ideale anche per la lavorazione dello zucchero.
Non-stick sheet ideal for backing brioches and buns as well as any kind of sweet bread backed in sheets. Ideal also for working sugar.

SILPAIN®

Supporto antiaderente areato ideale per la cottura di pani e per la cottura in bianco di fondi per crostate.
Non-stick perforated sheet ideal for baking bread and tarts.

ROUL'PAT®

Grazie al rivestimento in silicone su entrambi i lati, il supporto Roul'pat non scivola sul piano di lavoro. Permette di lavorare ogni tipo di pasta, ma anche di lavorare con grande facilità il croccante.
The silicone coating on both sides prevents the sheet from slipping. Perfect to prepare any type of dough and it also enables to easily prepare macaroon.



Tappeto silicone
 Silicone baking sheet
 Silikonbackfolie
 Tapis de cuisson en silicone
 Tela de cocción silicona

art.	dim. cm.	GN
47680-40	40x30	
47680-53	53x32,5	1/1
47680-60	60x40	

Tappeto silicone
 Silicone baking sheet
 Silikonbackfolie
 Tapis de cuisson en silicone
 Tela de cocción silicona

art.	dim. cm.	GN
47685-53	53x32,5	1/1
47685-60	60x40	

Tappeto silicone
 Silicone baking sheet
 Silikonbackfolie
 Tapis de cuisson en silicone
 Tela de cocción silicona

art.	dim. cm.
47688-60	60x40



Anello per torte, inox
 Tart ring, stainless steel
 Tortenring, Edelstahl Rostfrei
 Cercle à tarte, inox
 Anillo para tartas, inox

art.	Ø cm.	h.
47533-07	7	2
47533-08	8	2
47533-09	9	2
47533-10	10	2
47533-12	12	2
47533-14	14	2
47533-16	16	2
47533-18	18	2
47533-20	20	2
47533-22	22	2
47533-24	24	2
47533-26	26	2
47533-28	28	2
47533-30	30	2
47533-32	32	2

Anello per torte, inox
 Pudding ring, stainless steel
 Tortenringe, Edelstahl Rostfrei
 Cercle à entremet, inox
 Anillo para postres caseros, inox

art.	Ø cm.	h. cm.
47530-14	14	3,5
47530-16	16	3,5
47530-18	18	3,5
47530-20	20	3,5
47530-22	22	3,5
47530-24	24	3,5
47530-26	26	3,5
47530-28	28	3,5
47530-30	30	3,5

Anello per mousse, inox
 Mousse ring, stainless steel
 Schaumspeisenring, Edelstahl Rostfrei
 Cercle à mousse, inox
 Anillo para mousse, inox

art.	Ø cm.	h.
47532-06	6,0	4,0
47532-07	7,5	4,0
47532-08	8,0	4,5
47532-12	12,0	4,5
47532-14	14,0	4,5
47532-16	16,0	4,5
47532-18	18,0	4,5
47532-20	20,0	4,5
47532-22	22,0	4,5
47532-24	24,0	4,5
47532-26	26,0	4,5



Anello per torte gelato, inox
Ice cream cake ring, s/s
Eistortenring, Edelstahl Rostfrei
Cercle à vacherin, inox
Circulo alto, inox

art.	Ø cm.	h. cm.
47534-07	7	9
47534-08	9	9
47534-09	7	11
47534-10	9	11



Anello per torte gelato, inox
Ice cream cake ring, s/s
Eistortenring, Edelstahl Rostfrei
Cercle à vacherin, inox
Anillo para helados, inox

art.	Ø cm.	h. cm.
47534-06	6	6
47534-16	16	6
47534-18	18	6
47534-20	20	6
47534-22	22	6
47534-24	24	6
47534-26	26	6
47534-28	28	6



Anello regolabile, inox flessibile
Cake setting ring, flexible s/s
Tortenring, verstellbar, flexblem E. R.
Cercle à tarte, réglable, inox flexible
Anillo ajustable, inox flexible

art.	Ø min. cm.	Ø max. cm.	h. cm.
47529-07	16,5	32	7



Quadro, inox
Cake ring, s/s
Tortenform, Edelstahl Rostfrei
Cadre à tarte, inox
Marco para tarta, inox

art.	dim. cm.	h. cm.
47527-55	55x35,5	4,5

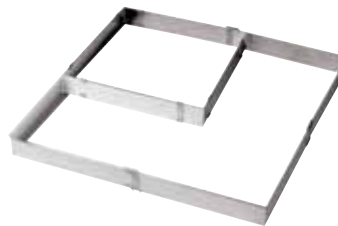

Telaio regolabile, inox
Extensible frame, s/s
Backrahm, verstellbar, Edelstahl
Bande à tarte réglable, inox
Marco para tarta, ajustable, inox

art.	dim. min. cm.	dim. max. cm.	h. cm.
47526-05	30x30	57x56	5



Telaio regolabile, inox flessibile
Rectangular cake setting ring, flexible s/s
Backform, verstellbar, flexblem E. R.
Marco à tarte, réglable, inox flexible
Banda para tarta, ajustable, inox flexible

art.	dim. min. cm.	dim. max. cm.	h. cm.
47528-05	19x28	34x54	5



Rettangolo, inox
Rectangle, s/s
Rechteck, Edelstahl Rostfrei
Rectangle, inox
Rectangular, inox

art.	dim. cm.	h. cm.
47546-18	18x36	5
47546-30	30x40	5
47546-40	40x60	5



Quadrato, inox
Square, s/s
Quadrat, Edelstahl Rostfrei
Carré, inox
Cuadrado, inox

art.	dim. cm.	h. cm.
47548-02	10x10	4,5
47548-03	18x18	4,5
47548-04	20x20	4,5
47548-05	22x22	4,5



Quadrato, inox
Square, s/s
Viereck, Edelstahl Rostfrei
Carré, inox
Cuadrado abombado, inox

art.	dim. cm.	h. cm.
47541-02	10x10	4,5
47541-03	18x18	4,5
47541-04	20x20	4,5



Ovale, inox
Oval, s/s
Oval, Edelstahl Rostfrei
Ovale, inox
Oval, inox

art.	Ø cm.	h.
47547-22	22	4
47547-26	26	4
47547-30	30	4



Virgola, inox
Comma, s/s
Komma, Edelstahl Rostfrei
Virgule, inox
Coma, inox

art.	Ø cm.	h.
47544-20	20	4
47544-25	25	4
47544-30	30	4



Cuore, inox
Heart, s/s
Herz, Edelstahl Rostfrei
Cœur, inox
Corazón, inox

art.	Ø cm.	h.
47542-18	18	4
47542-20	20	4
47542-22	22	4
47542-24	24	4
47542-26	26	4



Triangolo, inox
Triangle, s/s
Dreieck, Edelstahl Rostfrei
Triangle, inox
Triángulo, inox

art.	Ø cm.	h.
47540-02	12	4,5
47540-03	20	4,5
47540-04	22	4,5
47540-05	24	4,5



Triangolo, inox
Triangle, s/s
Dreieck, Edelstahl Rostfrei
Triangle, inox
Triángulo, inox

art.	Ø cm.	h.
47538-20	20	4
47538-23	23	4
47538-26	26	4



Semi-sfera, inox
Half sphere, s/s
Halbkugel, Edelstahl Rostfrei
Demi-sphère, inox
Semiesfera, inox

art.	Ø cm.	h.
47536-12	12	6
47536-14	14	7
47536-16	16	8
47536-18	18	9
47536-20	20	10



Piramide, inox
Pyramid, s/s
Pyramide, Edelstahl Rostfrei
Piramide, inox
Pirámide, inox

art.	Ø cm.	h.
47535-09	9	06
47535-12	12	08
47535-15	15	10
47535-17	17	12
47535-19	19	13



Crème caramel, inox
Crème caramel, s/s
Crème caramel, Edelstahl rostfrei
Crème caramel, inox
Molde para flan, inox

art.	Ø cm.	h.	ml.
41660-10	7	5	150
41660-15	7	6	180

PASTICCERIA PASTRY UTENSILS
PREPARAZIONE PREPARATION TOOLS



Tortiera, alluminio
Piepan, aluminum
Tortenform, Aluminium
Tourtière, alu
Molde, aluminio

art.	Ø cm.	h.
16940-28	28	5,0
16940-32	32	5,5
16940-36	36	6,0
16940-40	40	6,5



Ciambella, alluminio
Savarin tin, aluminum
Savarinform, Aluminium
Moule à savarin, alu
Molde para savarin, aluminio

art.	Ø cm.	h.	u.pack
47060-06	6,0	2,5	3
47060-07	7,5	3,0	3
47060-09	9,0	3,5	3
47060-10	10,0	3,5	3
47060-12	12,0	5,5	3
47060-14	14,0	5,5	3
47060-16	16,0	5,5	3



Ciambella, alluminio
Savarin tin, aluminum
Savarinform, Aluminium
Moule à savarin, alu
Molde para savarin, aluminio

art.	Ø cm.	h.	u.pack
47060-18	18,0	6,5	3
47060-20	20,0	6,5	3
47060-22	22,0	6,5	3
47060-24	24,0	8,5	3
47060-26	26,0	8,5	3
47060-30	30,0	8,5	3



Stampo americano, alluminio
Gugelhupf, aluminum
Gugelhupfppform, Aluminium
Moule à gugelhupf, alu
Molde gugelhupf, aluminio

art.	Ø cm.	h.
47062-18	18	10,5
47062-20	20	11,0
47062-22	22	12,0



Plumcake, alluminio
Plumcake, aluminum
Plumcake, Aluminium
Plumcake, alu
Molde para plumcake, aluminio

art.	dim. cm.	h.
47064-18	18x80	6
47064-22	22x90	7
47064-26	26x10	8
47064-30	30x11	9



Stampo per babà, alluminio
Beaker shaped tin, aluminum
Timbalform, Aluminium
Moule à dariole, alu
Molde, aluminio

art.	Ø cm.	h.	u.pack
47066-03	3	3,5	10
47066-04	4	4,5	10
47066-05	5	5,5	10
47066-06	6	6,0	10
47066-07	7	7,0	10
47066-08	8	8,0	10



Crème caramel, alluminio
Crème caramel, aluminum
Crème caramel, Aluminium
Crème caramel, alu
Molde para crème caramel, aluminio

art.	Ø cm.	h.	u.pack
41659-06	6	5,0	6
41659-07	7	5,5	6
41659-08	8	5,5	6



Stampo cassata, alluminio
Cassata mold, aluminum
Cassataform, Aluminium
Moule à cassata, alu
Molde para cassata, aluminio

art.	dim. cm.	h.
47068-12	12	10
47068-15	15	12



Stampo per zuccotto, alluminio
Zuccotto mold, aluminum
Zuccottoform, Aluminium
Moule à zuccotto, alu
Molde para zuccotto, aluminio

art.	Ø cm.
47069-10	10
47069-12	12
47069-14	14
47069-16	16
47069-18	18
47069-20	20

TORTIERE ANTIADERENTI NON STICK CAKE MOLDS



PASTICCERIA PASTRY UTENSILS
TORTIERE ANTIADERENTI NON STICK CAKE MOLDS



Tortiera pino
Pine mold
Tannenbaumform
Tourtière pin
Molde pino

art.	dim. cm.	h.
47005-24	17x24	8,5



Tortiera stella
Star, mold
Sternform
Tourtière étoile
Molde estrella

art.	dim. cm.	h.
47006-25	25x25	4,5



Tortiera festonata
Round mold, fluted edges
Runde Obsttortenform
Tourtière ronde bord cannelé
Molde acanalado

art.	Ø cm.	h.
47709-20	20	2,5
47709-24	24	2,5
47709-28	28	2,5
47709-32	32	2,5

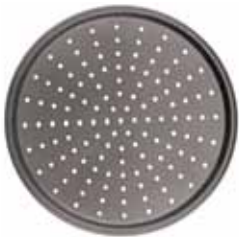

Tortiera forata
Crispy tart pan
Tortenform, gelocht
Tourtière perforée
Molde perforado

art.	Ø cm.	h.
41729-30	30	1,3
41729-34	34	1,3



Tortiera tonda
Round cake tin
Tortenform, rund
Manqué rond uni
Molde redondo

art.	Ø cm.	h.
47710-12	12	3,0
47710-16	16	4,0
47710-20	20	4,5
47710-24	24	5,0
47710-28	28	5,0
47710-32	32	5,5



Ciambella
Savarin tin
Savarinform
Moule pour savarin
Molde Savarin

art.	Ø cm.	h.	u.pack
47711-08	8	2,0	6
47711-12	12	2,5	6
47711-22	22	4,5	1
47711-24	24	5,0	1
47711-26	26	6,2	1



Tortiera festonata, fondo mobile
Round mold, fluted, loose bottom
Tortenform, gewellter Rand, Heheboden
Tourtière cannelée, fond mobile
Molde acanalado, fondo móvil

art.	Ø cm.	h.
47712-20	20	2,5
47712-24	24	2,5
47712-28	28	2,5
47712-32	32	2,5



Tortiera trois frères
Trois Frères ring
Frankfurter Kranzform
Tourtière trois frères
Molde trois frères

art.	Ø cm.	h.	u.pack
47713-22	22	5,5	6



Stampo americano
Gugelhupf cake pan
Gugelhupfpan
Moule à gugelhupf
Molde gugelhupf

art.	Ø cm.	h.
47705-22	22	10



Tortiera rettangolare
Loaf pan
Königskuchenform
Cake embouti
Molde rectangular

art.	dim. cm.	h.
47714-26	26x9,5	7,5
47714-28	28x10	7,5



Tortiera rettangolare apribile
Folding loaf pan
Aufklappbare-Königskuchenform
Cake ouvrant
Molde rectangular desmontable

art.	dim. cm.	h.
47715-30	30x10	7,5



Teglia rettangolare
Rectangular baking sheet
Rechteckige-Backform
Plaque rectangulaire
Placa rectangular

art.	dim. cm.	h.
47716-37	37x26	1,3

PASTICCERIA PASTRY UTENSILS



Tortiera fondo mobile
Rectangular mold, loose plate bottom
Backform, gerippt, Heheboden
Tourtière cannelée, fond mobile
Molde fondo móvil

art.	dim. cm.	h.
47717-35	35x11	2,5



Tortiera margherita
Baking mold "Margherit"
Margeriten-Backform
Moule à marguerite
Molde margarita

art.	Ø cm.	h.
47718-20	20	6



Tortiera festonata, fondo mobile
Round mold, fluted, loose bottom
Tortenform, gewellter Rand, Heheboden
Tourtière cannelée, fond mobile
Molde acanalado, fondo móvil

art.	Ø cm.	h.	u.pack
47719-10	10	3	6
47719-24	25	5	1



Tartelletta a barchetta
Oval boat mold
Schiffchenförmchen
Barquette unie
Molde barquilla

art.	Ø cm.	u.pack
47720-06	6	6
47720-08	8	6
47720-10	10	6
47720-12	12	6



Tartelletta a barchetta, festonata
Fluted oval boat mold
Schiffchenförmchen, gerippt
Barquette, cannelée
Molde barquilla, acanalado

art.	Ø cm.	u.pack
47721-08	8	6
47721-10	10	6
47721-12	12	6



Tartelletta tonda
Round plain mold
Backförmchen, rund
Tartellette ronde, unie
Molde redondo

art.	Ø cm.	u.pack
47722-05	5	6
47722-06	6	6
47722-07	7	6
47722-08	8	6
47722-10	10	6



Tartelletta tonda festonata
Round fluted mold
Backförmchen, rund, gerippt
Tartellette ronde, cannelée
Molde redondo, acanalado

art.	Ø cm.	u.pack
47723-05	5	6
47723-06	6	6
47723-07	7	6
47723-08	8	6
47723-10	10	6
47723-12	12	6



Tartelletta a brioche
Brioche mold
Brioche-Förmchen, gerippt
Brioche fond plat
Molde brioche

art.	Ø cm.	u.pack
47724-06	6	6
47724-08	8	6
47724-10	10	6
47724-11	11	6



Tartelletta rettangolare
Friand mold
Friand-Förmchen
Friand
Molde rectangular

art.	dim. cm.	u.pack
47725-09	10x5	6



Aspic ovale
Oval aspic mold, plain bottom
Ovale Aspikform, glatter Boden
Aspic ovale, fond uni
Molde oval

art.	dim. cm.	h.	u.pack
47726-07	7,5x5,5	3,8	6



Aspic ovale, fondo stella
Oval aspic mold, star bottom
Ovale Aspikform, Sternboden
Aspic ovale, étoilé
Molde oval, fondo estrella

art.	dim. cm.	h.	u.pack
47727-07	7,5x5,5	3,8	6



Stampo per babà
Rum baba mold
Runde Babaform
Dariole embouti
Molde para babà

art.	Ø cm.	h.	u.pack
47728-06	6	6	6

PASTICCERIA PASTRY UTENSILS
TORTIERE ANTIADERENTI NON STICK CAKE MOLDS



Scatola tartellette assortite
Box of small assorted molds
Satz Förmchen
Boîte petits fours, assortis
Surtido moldes



art.	pz. / pcs.
47730-24	24
47730-36	36
47730-60	60



Stampo per madeleines
Madeleine sheet
Madeleine-Backblech
Plaque madeleines
Molde Madeleine

art.	dim. cm.	h.	cup.
47731-12	26x20	1,4	7,2x4



Stampo per madeleinettes
Madeleinette sheet
Madeleinette-Backblech
Plaque madeleinettes
Molde Madeleine

art.	dim. cm.
47732-20	39,5x12,5



Tortiera rettangolare
Cake mold
Königskuchenform
Cake évasé
Molde ensanchado

art.	dim. cm.	h.
47733-18	18x7,5	6,5
47733-24	24x9	7,5
47733-30	30x10	8,0
47733-36	36x10,5	8,0



Charlotte
Charlotte mold
Charlotte-Form
Charlotte
Molde Charlotte

art.	Ø cm.	h.	u.pack
47734-18	18	10	6



Bavarese
Bavarois mold
Bayerische-Kuchenform
Moule Bavarois
Molde Bávaro

art.	Ø cm.	h.
47735-18	18	9



Bacinella paté con cerniera
Loaf pan with hinges, loose bottom
Springkassenform, Heheboden
Pâté à charnière, fond démontable
Molde con bisagra, fondo desmontable

art.	dim. cm.	h.
47736-30	30x8	8
47736-35	35x8	8
47736-40	40x8	8
47736-50	50x8	8



Stampo mini-paté
Mini paté mold
Pastetenkassenform
Mini-pâté à croûte
Molde minipaté

art.	dim. cm.	h.
47018-30	30x4	6
47018-50	50x4	6



Placca Denti di Lupo
Dents de Loup sheet
Backblech Dents de Loup
Plaque Dents de Loup
Placa para baguettes

art.	dim. cm.	h.
47014-30	29x30	2,5

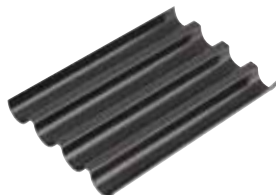

Teglia baguettes
Baguette baking pan
Baguetteform
Plaque à baguettes
Placa para baguettes

art.	dim. cm.	h.
47014-35	35x24,5	2,5



Tortiera festonata, fondo mobile
Square mold, fluted, loose bottom
Tortenform, gewellter Rand, Heheboden
Tourtière carrée, cannelée, fond mobile
Molde cuadrado, acanalado, fondo móvil

art.	dim. cm.	h.
47738-23	23x23	2,5



Tortiera tonda
Round mold
Tortenform, rund
Tourtière ronde
Molde redondo

art.	Ø cm.	h.	u.pack
47739-12	12	2,1	6
47739-24	24	2,3	1
47739-28	28	2,3	1
47739-32	32	2,5	1

PASTICCERIA PASTRY UTENSILS



Tartelletta savarin
Savarin mold
Savarinförmchen
Savarin
Molde savarin

art.	Ø cm.	h.	u.pack
47757-65	6,5	1,5	6
47757-80	8,0	2,0	6



Tartelletta festonata, fondo mobile
Round fluted mold, loose bottom
Runde, gewellte Tortellets, Heheboden
Tartelette ronde cannelée, fond mobile
Molde redondo acanalado, fondo móvil

art.	Ø cm.	h.	u.pack
47758-10	10	1,8	6
47758-12	12	2,0	6



Tartelletta foglia di quercia
Oak leaf tart mold
Törtchenform Eichenblatt
Tartelette feuille chêne
Molde pasteles

art.	Ø cm.	h.	u.pack
47759-12	12	2	6



Tartelletta foglia di vite
Wine leaf tart mold
Törtchenform Weinblatt
Tartelette feuille vigne
Molde pasteles

art.	Ø cm.	h.	u.pack
47760-12	12	2	6



Tartelletta
Small mold
Pralinen-förm
Petit four
Molde pasteles

art.	Ø cm.	u.pack
47747-01	4,5	6



Tartelletta
Small mold
Pralinen-förm
Petit four
Molde pasteles

art.	Ø cm.	u.pack
47723-05	5	6



Tartelletta
Small mold
Pralinen-förm
Petit four
Molde pasteles

art.	Ø cm.	u.pack
47747-03	4,5	6



Tartelletta
Small mold
Pralinen-förm
Petit four
Molde pasteles

art.	Ø cm.	u.pack
47747-04	3,5	6



Tartelletta
Small mold
Pralinen-förm
Petit four
Molde pasteles

art.	Ø cm.	u.pack
47747-05	4,5	6



Tartelletta
Small mold
Pralinen-förm
Petit four
Molde pasteles

art.	Ø cm.	u.pack
47747-06	6	6



Tartelletta
Small mold
Pralinen-förm
Petit four
Molde pasteles

art.	Ø cm.	u.pack
47747-07	6	6



Tartelletta
Small mold
Pralinen-förm
Petit four
Molde pasteles

art.	Ø cm.	u.pack
47747-09	5	6



Tartelletta
Small mold
Pralinen-förm
Petit four
Molde pasteles

art.	Ø cm.	h.	u.pack
47747-10	4,0	1,0	6
47747-11	3,5	1,4	6



Stampo tartelletta
Cup bun pan
Backblech
Plaque tartelettes
Molde pasteles

art.	dim. cm.	h.	Ø
47748-35	35,5x27	2,5	4,5 - 6,5



Stampo pupazzo di neve
Snowman pan
Schneemann-Backblech
Plaque bonhomme de neige
Molde muñeco de nieve

art.	dim. cm.	h.
47763-31	31x19,7	5

PASTICCERIA PASTRY UTENSILS
TORTIERE ANTIADERENTI NON STICK CAKE MOLDS



Stampo pupazzo di neve
Snowman mold
Schneemann-Backblech
Plaque bonhomme de neige
Molde muñeco de nieve



art. dim. cm.
47762-23 23x5



Stampo Babbo Natale
Santa Claus mold
Weihnachtsmann-Backblech
Plaque Père Noël
Molde Papá Noel



art. dim. cm.
47761-23 23x4,8



Stampo Babbo Natale
Santa Claus pan
Weihnachtsmann-Backblech
Plaque Père Noël
Molde Papá Noel

art. dim. cm. h.
47761-30 30,5x26 5



Stampo di Natale
Christmas style mold
Weihnachts-Backblech
Plaque de Noël
Molde de Noel



art. dim. cm. h. cup ø cm.
47750-06 31,5x21,5 2,5 8,3x2,5



Stampo motivi pasquali
Easter muffin pan
Ostern-Backblech
Plaque Pâque
Molde Pascua

art. dim. cm. h.
47749-35 35x27 3



Stampo uovo
Egg mold
Ostereierform
Moule à oeuf
Molde para huevos



art. dim. cm.
47007-26 26x8,3



Stampo coniglietto di Pasqua
Easter rabbit pan
Osternhase-Backblech
Plaque lapin de Pâque
Molde conejo de Pascua

art. dim. cm. h.
47764-10 10,8x14,5 3



Stampo coniglietto di Pasqua
Easter rabbit mold
Osternhase-Backblech
Plaque lapin de Pâque
Molde conejo de Pascua



art. dim. cm.
47764-12 12x2,6



Stampo coniglio di Pasqua
Easter rabbit mold
Osternhase-Backblech
Plaque lapin de Pâque
Molde conejo de Pascua



art. dim. cm.
47764-28 28x5,4



Stampo carré
Loaf pan
Königskuchenform
Cake évasé
Molde ensanchado



art. dim. cm. h.
47752-09 9,5x6 3,8



Stampo carré
Loaf pan
Königskuchenform
Cake évasé
Molde ensanchado



art. dim. cm. h.
47752-16 15x7,5 4,8



Stampo carré
Loaf pan
Königskuchenform
Cake évasé
Molde ensanchado



art. dim. cm. h.
47752-21 21x10,8 5,8

PASTICCERIA PASTRY UTENSILS



P



Stampo carré, fondo festonato
Fluted loaf pan
Königskuchenform, gerippt
Cake évasé, fond cannelé
Molde ensanchado, fondo acanalado

art.	dim. cm.	h.
47753-31	31x12	5,0



P

Stampo apribile
Springform mold
Springform
Manqué démontable
Molde desmontable

art.	Ø cm.	h.
47754-20	20,5	6,5
47754-24	24,0	6,5
47754-26	26,0	6,5
47754-28	28,0	6,7



P

Stampo cuore
Heart pan
Herz-Backblech
Plaque coeur
Molde corazón

art.	dim. cm.	h.
47751-23	23x24,5	4,5



P

Stampo ciambella apribile
Fluted springform pan
Savarinspringform
Manqué savarin démontable
Molde savarin desmontable

art.	Ø cm.	h.
47756-20	20,5	4,7
47756-24	24,0	6,8
47756-26	26,0	6,5
47756-28	28,0	6,7

Stampo apribile, 6 fondi
Springform mold with 6 bottoms
Springform mit 6 Böden
Manqué démontable, 6 fonds
Molde desmontable, 6 fondos

art.	Ø cm.	h.
47755-26	26	6



Tampone finto legno
Rubber comb, wood effect
Kamm aus Kunststoff, holzartig
Peigne faux bois
Peine de goma, efecto madera

art.	l. cm.
47684-15	15



Pettine Charlotte con telaio, inox
Comb for Charlotte with frame, s/s
Charlotte-Kamme mit Rahmen, E. R.
Peigne à Charlotte avec cadre, inox
Peine para Charlotte con marco, inox

art.	dim. cm.
47670-02	57x36,5



Appoggiare il telaio su un tappetino di silicone e stendere il biscuit charlotte uniformemente. Posizionare il pettine sul telaio e tirarlo verso di sé.
Put the frame on a silicone mat. Spread uniformly the charlotte biscuit. Place the comb on the frame between the guides and draw towards you.



Pettine inox con 5 fasce gomma
Stainless steel comb with 5 rubber blades
Kamm, Edelstahl mit 5 Gummiklingen
Peigne inox avec 5 bandes à décor
Peine inox con 5 láminas de goma

art.	dim. cm.
47672-05	70x10



Spalmare uniformemente la pasta decoro sul foglio di silicone. - Spread uniformly the decorating paste on the silicone sheet.



Appoggiare il pettine e tirare. Passare in congelatore. - Pull the comb in the chosen direction. Put it in a freezer.



Stendere il biscuit. Cuocere in forno a 230° per 8 minuti. - Spread the biscuit on the motif obtained. Bake in oven at 230° C for 8 mins.



Appoggiare il biscuit su un foglio e togliere delicatamente il silicone. - Place the biscuit on a greaseproof paper sheet upside down and remove carefully the silicone sheet.



Tagliare le fasce di biscuit nella larghezza desiderata. - Cut the biscuit into stripes.



Mettere la fascia di biscuit nella forma desiderata. Put the stripes obtained in the mold previously chosen.

PASTICCERIA PASTRY UTENSILS
PREPARAZIONE PREPARATION TOOLS

GRIGLIA PER DECORO BISCUIT, INOX - GRILL FOR BISCUIT, STAINLESS STEEL
GITTER FÜR BISCUIT, EDELSTAHL ROSTFREI - GRILLE POUR BISCUIT, INOX - REJILLA PARA GALLETA, INOX



Appoggiare la griglia su un tappeto di silicone. Spatolare la pasta decoro uniformemente. Togliere la griglia e passare in congelatore. Successivamente stendere il biscuit. Cuocere in forno a 230°C per 8 minuti, appoggiare il biscuit capovolto su un foglio e togliere delicatamente il tappeto. Tagliare le fasce di biscuit nella larghezza desiderata. - Place the grill on silicone mat. Spread uniformly the decorating paste. Take off the grid and put into refrigerator. Afterwards spread uniformly the biscuit. Bake in the oven at 230°C for 8 minutes. Place the biscuit upside down on a greaseproof paper and remove carefully the silicone mat. By using an extensible pastry cutter cut the biscuit into stripes.



art. 47674-01 dim. cm. 60x40



art. 47674-02 dim. cm. 60x40



art. 47674-03 dim. cm. 60x40



art. 47674-04 dim. cm. 60x40



art. 47674-05 dim. cm. 60x40



art. 47674-06 dim. cm. 60x40



art. 47674-07 dim. cm. 60x40



art. 47674-08 dim. cm. 60x40

PLACCA PER PASTA FROLLA, PLASTICA - STENCIL-MAT, PLASTIC
AUSSTECHEMATTE, KUNSTSTOFF - PLAQUE À PÂTE BRISÉE, PLASTIQUE - REJILLA PARA GALLETA, PLÁSTICO



Facili da usare permettono un gran risparmio di tempo. Ideali per la preparazione di biscotti, pizzette, salatini e basi per pasticcini.
Easy to use, they allow a great saving of time. Ideal to prepare cookies, pizzas, savoury biscuit and pastry bases.



art. 47675-01 dim. cm. 58x39 Ø 8,8 n. 20
47675-02 dim. cm. 58x39 Ø 4,5 n. 72

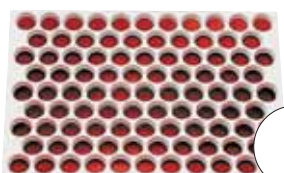

art. 47675-03 dim. cm. 58x39 Ø 5,5 n. 53

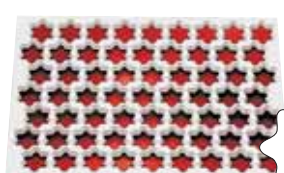

art. 47675-04 dim. cm. 58x39 Ø 5,2 n. 63



art. 47675-05 dim. cm. 58x39 Ø 4,5 n. 60

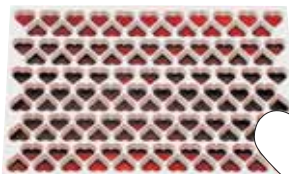

art. 47675-06 dim. cm. 58x39 Ø 4 n. 95

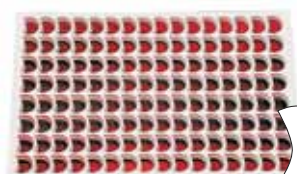

art. 47675-07 dim. cm. 58x39 Ø 5 n. 78



art. 47675-08 dim. cm. 58x39 Ø 5 n. 68



art. 47675-09 dim. cm. 58x39 Ø 7,5 n. 24
Ø 6,0 n. 26

PASTICCERIA PASTRY UTENSILS

GRIGLIA PER DECORO BISCUIT, PLASTICA - GRILL FOR BISCUIT, PLASTIC
 5GITTER FÜR BISCUIT, KUNSTSTOFF - GRILLE POUR BISCUIT, PLASTIQUE - REJILLA PARA GALLETA, PLÁSTICO



Appoggiare la griglia su di un foglio in silicone.
 Spatolare la pasta decoro uniformemente.
 Place the grill on a silicone sheet. Spread the decorating paste.



Togliere la griglia e passare il decoro realizzato in congelatore.
 Take off the grill and put into refrigerator.



Stendere il biscuit aiutandosi con una cornice e una spatola. - Afterwards spread the biscuit using a frame and a spatula.

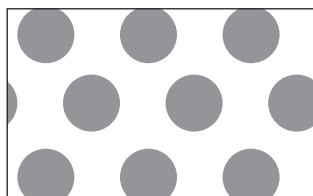

art. dim. cm. Ø
 47677-01 60x40 0,7
 47677-02 60x40 0,9



art. dim. cm.
 47677-03 60x40

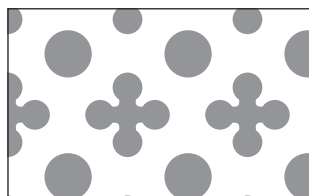

art. dim. cm.
 47677-04 60x40

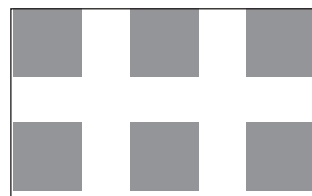

art. dim. cm.
 47677-05 60x40



art. dim. cm.
 47677-06 60x40



art. dim. cm.
 47677-07 60x40



art. dim. cm.
 47677-08 60x40

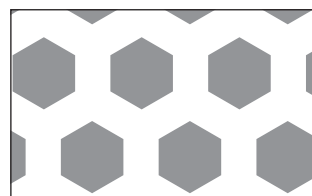

art. dim. cm.
 47677-09 60x40

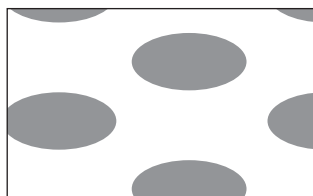

art. dim. cm.
 47677-10 60x40

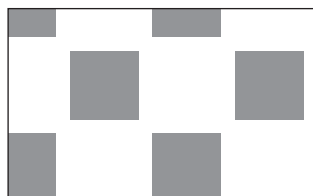

art. dim. cm.
 47677-11 60x40



art. dim. cm.
 47677-12 60x40



art. dim. cm.
 47677-13 60x40



art. dim. cm.
 47677-14 60x40

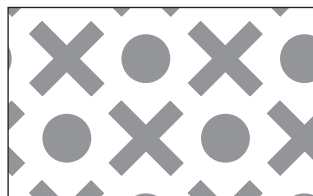

art. dim. cm.
 47677-15 60x40

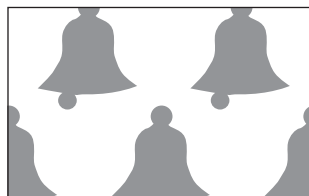

art. dim. cm.
 47677-16 60x40



art. dim. cm.
 47677-17 60x40



art. dim. cm.
 47677-18 60x40

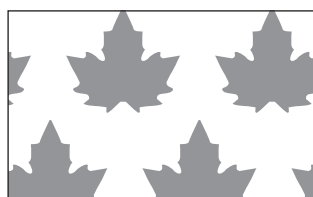

art. dim. cm.
 47677-19 60x40



art. dim. cm.
 47677-20 60x40



CORNICE, PST - FRAME
 RAHMEN - CADRE - MARCO

art. dim. cm. h.
 47677-23 60x40 0,3
 47677-24 60x40 0,4
 47677-25 60x40 0,5

TEGLIE MONOPORZIONI - MONOPORTION TRAY MOLDS

		gr.20			gr.75		
	dim. cm.	Teglia Tray	Estrattore Extractor	Tagliapasta Cutter	Teglia Tray	Estrattore Extractor	Tagliapasta Cutter
	60x40	47651-01	47656-01	47655-01	47652-01	47658-01	47657-01
	60x40	47651-02	47656-02	47655-02	47652-02	47658-02	47657-02
	60x40	47651-03	47656-03	47655-03	47652-03	47658-03	47657-03
	60x40	47651-04	47656-04	47655-04	47652-04	47658-04	47657-04
	60x40	47651-05	47656-05	47655-05	47652-05	47658-05	47657-05
	60x40	47651-07	47656-07	47655-07	47652-07	47658-07	47657-07



Stencil
Stencil
Stencil
Stencil
Stencil

art. 47875-11 dim. cm. 31x51 cm. 13x3 pz./pcs 30



Stencil
Stencil
Stencil
Stencil
Stencil

art. 47875-13 dim. cm. 31x51 cm. 7,5x3,5 pz./pcs 40



Stencil
Stencil
Stencil
Stencil
Stencil

art. 47875-14 dim. cm. 31x51 cm. 6,5x4 pz./pcs 32

STAMPI IN SILICONE PER PRALINE - PRALINE'S SILICONE MOLDS



Pratici stampi in silicone flessibili e resistenti per creazioni dolci o salate (snack, tartufi, gelatine, praline). Ideali per realizzare grandi quantità in poco tempo. Resistono da -40° a +280°C. Utilizzabili in forno, frigorifero e abbattitore.



Practical, flexible and resistant silicone molds for sweet or salty creations (snaks, truffles, jellies, pralines). Perfect to make large quantities in short time. They withstand from -40° to +280°C. Can be used in the oven, refrigerator and blast chiller.

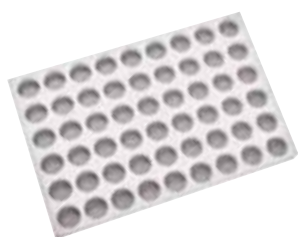

art. 47783-01 ø mm. 26 h. 14 pcs 54

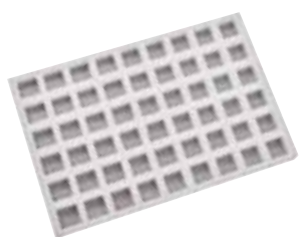

art. 47783-02 dim. mm. 23x23 h. 14 pcs 54



art. 47783-03 dim. mm. 35x14,5 h. 14 pcs 63

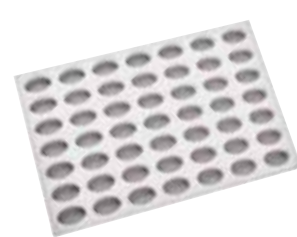

art. 47783-04 dim. mm. 32x21 h. 14 pcs 49

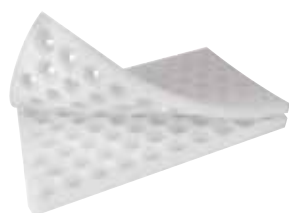

art. 47783-11 ø mm. 26 h. 14 pcs 54



art. 47783-12 ø mm. 30-10 h. 12 pcs 40



art. 47783-13 dim. mm. 90x30 h. 19 pcs 15



art. 47783-14 dim. mm. 90x30 h. 19 pcs 15



CIOCCOLATO - CHOCOLATE

STAMPI CIOCCOLATO - CHOCOLATE MOLDS
SCHOKOLADENFORMEN - MOULES À CHOCOLAT- MOLDES PARA CHOCOLATE



Stampi policarbonato. Misure stampo 17,5x27,5 cm. - Polycarbonate chocolate molds. Mold size 17,5x27,5 cm.



art. 47860-36 dim. mm. 25x25 h. 25 pcs 40



art. 47860-37 dim. mm. 36x22 h. 20 pcs 36



art. 47860-85 dim. mm. 35x22 h. 16 pcs 35



art. 47860-35 ø mm. 30 h. 19 pcs 28



art. 47860-46 dim. mm. 35x20 h. 17 pcs 40



art. 47860-48 ø mm. 28 h. 24 pcs 40



art. 47860-49 ø mm. 30 h. 22 pcs 28



art. 47860-58 dim. mm. 17x12 h. 5 pcs 130



art. 47860-40 ø mm. 29 h. 21 pcs 40



art. 47860-68 ø mm. 28 h. 25 pcs 40



art. 47860-42 dim. mm. 35x23 h. 16 pcs 36



art. 47860-43 dim. mm. 38x28 h. 18 pcs 30



art. 47860-81 dim. mm. 30x18 h. 15 pcs 30

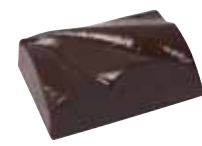

art. 47860-31 dim. mm. 33x25 h. 12 pcs 24



art. 47860-83 dim. mm. 30x30 h. 15 pcs 24



art. 47860-84 ø mm. 26 h. 19 pcs 35

PASTICCERIA PASTRY UTENSILS



art. 47860-18 ø mm. 27 h. 17 pcs 24



art. 47860-21 ø mm. 29 h. 18 pcs 24



art. 47860-27 dim. mm. 27x27 h. 13 pcs 28



art. 47860-17 dim. mm. 30x30 h. 12 pcs 24



art. 47860-24 dim. mm. 40x42 h. 15 pcs 15



art. 47860-74 dim. mm. 32x32 h. 4 pcs 24



N



N

art. 47860-75 dim. mm. 20x20 h. 16 pcs 28



N

art. 47860-38 dim. mm. 48x18,5 h. 19 pcs 16



N

art. 47860-44 dim. mm. 28x32 h. 15 pcs 32



N

art. 47860-39 dim. mm. 30x18 h. 15 pcs 30



N

art. 47860-50 ø mm. 26 h. 15 pcs 35



N

art. 47860-62 ø mm. 27 h. 20 pcs 30



N

art. 47860-53 dim. mm. 22x22 h. 22 pcs 28



N

art. 47860-55 dim. mm. 26x20 h. 21 pcs 28



N

art. 47860-56 ø mm. 24 h. 21 pcs 28



N

art. 47860-57 dim. mm. 26x20 h. 21 pcs 28



N

art. 47860-60 ø mm. 25 h. 18,5 pcs 28



N

art. 47860-61 dim. mm. 30x20 h. 17,5 pcs 28



N

art. 47860-63 ø mm. 27 h. 20 pcs 30



N

art. 47860-66 dim. mm. 25x25 h. 15 pcs 30



N

art. 47860-67 dim. mm. 25x25 h. 15 pcs 30



N

art. 47860-69 dim. mm. 40x20 h. 18 pcs 30



N

art. 47860-70 dim. mm. 40x18 h. 15 pcs 30



N

art. 47860-71 dim. mm. 26x26 h. 20 pcs 30



N

art. 47860-73 dim. mm. 31x22 h. 22 pcs 5x6





Stampo magnetico per la realizzazione di praline serigrafate, PC
Magnetic mold to create silkscreened pralines, PC

art.	ø mm.	gr.	pcs	art.	dim. mm.	gr.	pcs	art.	dim. mm.	gr.	pcs	art.	dim. mm.	gr.	pcs
47863-01	30	13	15	47863-02	33x25	15	15	47863-03	27x27	13	15	47863-04	27x25	10	15



Collocare il foglio serigrafato sul fondo dello stampo tagliandolo a misura. - Place the silk screen sheet on the base of the mold, cutting it to the right size.



Posare il foglio con la parte trasferibile verso l'alto e chiudere lo stampo. - Put the sheet with the transfer part facing upwards and close the mold.



Riempire gli stampi e lasciare solidificare il cioccolato. - Fill with chocolate and leave to cool.



Raffreddati, sformare i cioccolatini. When cool, open the mold and turn out the chocolates.



Tavolette cioccolato, set 5 pz, PE
Chocolate Bars, set 5 pcs
Schokoladentafel, 5-tlg
Tablettes chocolat, 5 pièces
Tabletas chocolate, 5 piezas



art.	dim. cm.
47870-17	15x17
47870-18	15x17
47870-19	15x17



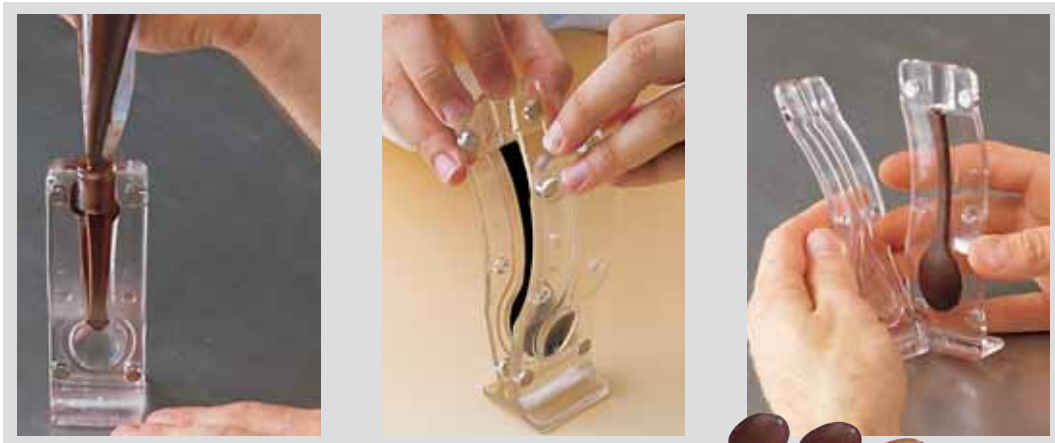

Stampo cucchiaino, PC
Spoon mold, PC

art. dim. mm.
47860-90 25x95



Entrambe le misure si prestano come monoporzioni e per la realizzazione di dessert al piatto, mousse o semifreddo. - Both coffee pot measures are suitable to be used as a single portion or creation of desserts, as decoration with mousse or semifreddo.



Stampo tazzina e piattino, PC
Coffee cup and saucer mold, PC

art.		ø mm	h	pz/pcs	stampo/mold dim. cm
47860-91	tazza/cup	51	32	7	17,5x27,5
47860-92	tazza/cup	59	36	7	17,5x27,5
47860-93	piattino/saucer	80		5	17,5x27,5
47860-94	piattino/saucer	91		3	17,5x27,5



Stampo uovo, plastica rigida (PETG)
Egg mold, strong plastic (PETG)
Ostereierform
Moule à oeuf
Molde para huevos

art.	dim. cm.	kg.
47876-11	17x25	0,5-1,0
47876-12	18x28	0,8-1,2
47876-13	34x25	1,5-2,0
47876-14	27x40	2,0-2,5
47876-15	32x45	2,5-3,5
47876-16	36x54	4,0-6,0
47876-17	43x64	6,0-8,0
47876-18	50x75	8,0-10,0



Stampo uovo, PE
Egg mold, PE
Ostereierform, PE
Moule à oeuf, PE
Molde para huevos, PE

art.	mm.	pcs
47865-44	220x160x85	1
47865-23	110x80x40	2
47865-80	112x83x44	2
47865-81	125x94x44	2
47865-82	140x100x50	2
47865-83	154x110x55	2



Stampo uovo, PE
Egg mold, PE
Ostereierform, PE
Moule à oeuf, PE
Molde para huevos, PE

Stampo uovo, PE
Egg mold, PE
Ostereierform, PE
Moule à oeuf, PE
Molde para huevos, PE

Stampo uovo, PE
Egg mold, PE
Ostereierform, PE
Moule à oeuf, PE
Molde para huevos, PE

art.	mm.	pcs
47865-66	80x60x25	4
47865-73	40x31x17	14
47865-71	36x23x12	18

art.	mm.	pcs
47865-77	140x100x49	1
47865-76	95x70x40	2
47865-75	83x54x24	4

art.	mm.	pcs
47865-74	64x44x26	6
47865-72	39x25x13	14



STAMPI 3D, CORPO CAVO, PC - 3D HOLLOW MOLDS, PC
3D-HOHLFORME, PC - MOULES CREUSES 3D, PC - MOLDE 3D, PC



art.	h. mm.	#
47793-11	170	1

art.	h. mm.	#
47793-12	180	1

art.	h. mm.	#
47793-13	140	1

art.	h. mm.	#
47793-14	195	1



art.	h. mm.	#
47793-15	170	2

art.	h. mm.	#
47793-16	150	1

art.	h. mm.	#
47793-17	160	2
47793-18	205	1

art.	h. mm.	#
47793-19	110	1
47793-20	160	1

PASTICCERIA PASTRY UTENSILS



art. 47793-21 h. mm. 125 # 2



art. 47793-22 h. mm. 125 # 2



art. 47793-23 h. mm. 110 # 3



art. 47793-24 h. mm. 145 # 1



art. 47793-25 h. mm. 97 # 2



art. 47793-26 h. mm. 110 # 1
art. 47793-27 h. mm. 140 # 1



art. 47793-32 h. mm. 122 # 3



art. 47793-33 h. mm. 180 # 1



art. 47793-40 h. mm. 168 # 1



art. 47793-41 h. mm. 185 # 1



art. 47793-42 h. mm. 180 # 1



art. 47793-43 h. mm. 114 # 3



art. 47793-44 h. mm. 192 # 1



art. 47793-45 h. mm. 135 # 1



art. 47793-55 mm. 220x75x170 # 1



art. 47793-51 mm. 195x60x80 # 1



art. 47793-52 mm. 120 # 1



art. 47793-53 mm. 95x90x110 # 1



art. 47793-54 mm. 140x140x150 # 1

N

STAMPI CIOCCOLATO 3D IN SILICONE - 3D CHOCOLATE MOLDS, SILICONE
3D-SCHOKOLADENFORMEN, SILIKON - MOULES 3D À CHOCOLAT, SILICONE - MOLDES 3D PARA CHOCOLATE, SILICONA



Per impreziosire i soggetto di cioccolato utilizzare l'aerografo e coloranti idroalcolici. - To embellish the chocolate subjects use airbrush and hydroalcoholic colors.



art. 47870-21 dim. mm. 80x40x117



art. 47870-26 dim. mm. 65x80x100



art. 47870-22 dim. mm. 80x70x135



art. 47870-27 dim. mm. 80x60x105



art. 47870-23 dim. mm. 60x65x130



art. 47870-25 dim. mm. 105x95x125



art. 47870-28 dim. mm. 85x70x85



art. 47870-24 dim. mm. 77x55x130



art. 47870-31 dim. mm. 100x80x140



art. 47870-33 dim. mm. 77x80x120



art. 47870-29 dim. mm. 80x65x110



art. 47870-30 dim. mm. 80x60x115

PASTICCERIA PASTRY UTENSILS



art. 47870-32 dim. mm. 100x77x125



art. 47870-40 dim. mm. 65x60x85



art. 47870-38 dim. mm. 145x100x20



art. 47870-35 dim. mm. 120x75x115



art. 47870-34 dim. mm. 80x65x95



art. 47870-36 dim. mm. 110x70x120



art. 47870-37 dim. mm. 65x60x80



art. 47870-39 dim. mm. 85x50x80



art. 47870-41 dim. mm. 75x65



art. 47870-43 dim. mm. 80x35x140



art. 47870-42 dim. mm. 95x90x50



art. 47870-44 dim. mm. 45x35x120



N

STAMPI PER GELATINE - JELLY MOLDS
GELEEFORMEN - MOULES À GELÉES - MOLDES PARA GELATINAS

DIMENSIONE PLACCA - MOLDS SIZE: 18X33,5 CM



PZ. - PCS.: 24



Stampi in puro silicone alimentare, per la realizzazione di gelatine alla frutta, fondenti, ecc. Con telaio in plastica.
Silicone molds for fruit jelly, fondant, etc. With plastic frame.



47676-01

47676-02

47676-03

47676-04

47676-05

47676-06

47676-17

47676-18

47676-09

Fetta Arancio
Orange Slice

Pera
Pear

Cuore
Heart

Mezzasfera
Halfsphere

Bon Bon
Pastille

Mora
Berry

Ananas
Pineapple

Fragola
Strawberry

Pesca
Peach

dim. mm
45x18x15

dim. mm
40x26x15

dim. mm
34x30x18

dim. mm
ø27xh13,5

dim. mm
ø30xh11

dim. mm
ø30xh24

dim. mm
33x23x18

dim. mm
36x30x20

dim. mm
35x25x20

PLACCHE MULTIPORZIONE 400X300 MM MULTIPORTION TRAYS 400X300 MM

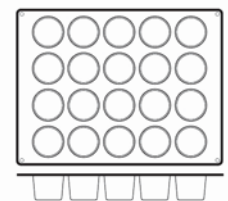
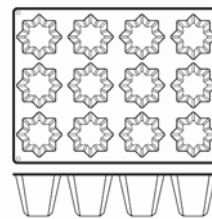
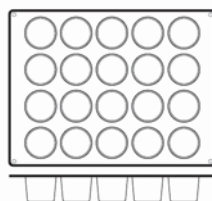
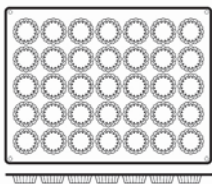

Fluted Muffins

art. 47780-01 ø mm. 50 h. 15 pcs 35

Mini-Panettone

art. 47780-02 ø mm. 70 h. 40 pcs 20

Mini-Pandoro

art. 47780-03 ø mm. 85 h. 90 pcs 12

Muffins

art. 47780-04 ø mm. 70 h. 42 pcs 12



Pratici e funzionali, ideali sia per la surgelazione che per la cottura anche in forno a microonde. Possono essere utilizzati a temperature che variano da -60°C a +260°C. Facili da sformare, non attaccano e non necessitano di preparazione. Facili da lavare sia a mano che in lavastoviglie. Formato 17,5x30 cm equivalente a 1/3 Gastronorm ed a 1/4 del formato della teglia da pasticceria (cm 60x40). Realizzati in purissimo silicone conforme alle norme internazionali che regolano l'utilizzo di materiali destinati al contatto con sostanze alimentari: D.M. n. 104 del 21/03/1973 (legislazione italiana) - Arrêté du 25/11/1992 (legislazione francese) - BGVV (legislazione tedesca) - FDA (legislazione statunitense).

Practical and functional, perfect for freezing or baking also in microwave ovens. Can be used with temperatures ranging from -60°C to +260°C. Easy to demold, does not stick. No need of preparation. Can be washed manually as well as into dishwashers. Dimension 17,5x30 cm equal to Gastronorm 1/3 and 1/4 of Baknorm size (cm 60x40). Manufactured in conformity with international regulations concerning food contact: D.M. no. 104 of 21/03/1973 (Italian law) - Arrêté du 25/11/1992 (French law) - BGVV (German law) - FDA (USA law).



Hearts
art. mm. h. pcs
47742-32 55x50 35 6



Hearts
art. mm. h. pcs
47742-25 65x60 35 8



Maxi Muffins
art. ø mm. h. pcs
47742-33 80 35 5



Muffins
art. ø mm. h. pcs
47742-08 70 37 6



Mini-Muffins
art. ø mm. h. pcs
47742-20 50 28 11



Briochettes
art. ø mm. h. pcs
47742-12 79 37 6



Mini-Gugelhupf
art. ø mm. h. pcs
47742-34 70 36 6



Tartelettes
art. ø mm. h. pcs
47742-19 60 17 8



Mini-Madeleins			
art.	mm.	h.	pcs
47742-37	42x30	11	20



Tartelettes			
art.	ø mm.	h.	pcs
47742-16	50	15	15



Madeleins			
art.	mm.	h.	pcs
47742-21	78x45	17	9



Mini-Madeleins			
art.	mm.	h.	pcs
47742-36	65x32	13	15



Financiers			
art.	mm.	h.	pcs
47742-28	80x30	30	9



Cannelles			
art.	ø mm.	h.	pcs
47742-27	79	30	6



Cannelles			
art.	ø mm.	h.	pcs
47742-41	50	50	8



Mini-Cannelles			
art.	ø mm.	h.	pcs
47742-42	35	35	18



Savarins			
art.	ø mm.	h.	pcs
47742-15	72	23	6

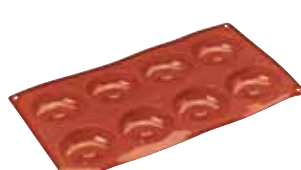

Savarins			
art.	ø mm.	h.	pcs
47742-10	65	21	8



Savarins			
art.	ø mm.	h.	pcs
47742-05	40	12	18



Babà			
art.	ø mm.	h.	pcs
47742-02	55	60	8



Babà			
art.	ø mm.	h.	pcs
47742-30	45	48	11



Babà			
art.	ø mm.	h.	pcs
47742-31	35	38	15



Half-Sphere			
art.	ø mm.	h.	pcs
47742-29	80	40	5



Half-Sphere			
art.	ø mm.	h.	pcs
47742-01	70	35	6



Half-Sphere			
art.	ø mm.	h.	pcs
47742-48	50	25	15



Half-Sphere			
art.	ø mm.	h.	pcs
47742-03	40	20	15



Half-Sphere			
art.	ø mm.	h.	pcs
47742-04	30	15	24



Half-Sphere			
art.	ø mm.	h.	pcs
47742-47	60	30	8

PASTICCERIA PASTRY UTENSILS



Bavarese			
art.	ø mm.	h.	pcs
47742-51	60	50	8



Muffins			
art.	ø mm.	h.	pcs
47742-24	40	20	15



Cakes			
art.	mm.	h.	pcs
47742-56	80x30	30	12



Ovals			
art.	mm.	h.	pcs
47742-09	53	33	16



Pyramids			
art.	mm.	h.	pcs
47742-07	71x71	40	6



Pyramids			
art.	mm.	h.	pcs
47742-13	36x36	22	15



Mini-Financiers			
art.	mm.	h.	pcs
47742-14	49x26	11	20



Cylinder			
art.	ø mm.	h.	pcs
47742-17	60	35	8



Pomponets			
art.	ø mm.	h.	pcs
47742-06	34	16	24



Cakes			
art.	ø mm.	h.	pcs
47742-61	80	18	6



Bisquits			
art.	ø mm.	h.	pcs
47742-23	103	20	3

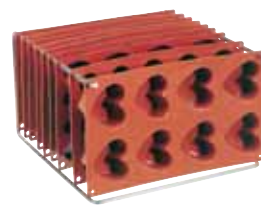

Sgocciolatore - Drainer		
art.	dim.cm.	h.
47742-00	30x30	17,5

TORTIERE PIE PANS



Round Cake		
art.	ø mm.	h.
47765-26	260	40
47765-28	280	40



Pandoro			
art.	kg.	øcm.	h.
47784-05	0,50	14	10,0
47784-07	0,75	16	11,0



Plumcake		
art.	ø mm.	h.
47773-24	240x100	75
47773-28	280x105	75



Panettone			
art.	kg.	øcm.	h.
47785-07	0,75	21,0	15
47785-10	1,00	23,5	14



Savarin		
art.	ø mm.	h.
47772-24	240	60



Square		
art.	mm.	h.
47768-24	260x260	55



Heart		
art.	mm.	h.
47770-21	220x218	35



DEMARLE®

FLEXIPAN

Flexipan®, un materiale che unisce fibra di vetro e silicone alimentare. Una combinazione che conferisce al prodotto una solidità e una longevità senza pari, oltre a straordinarie proprietà antiaderenti. Resistenza alla temperatura da -40°C a +280°C. Flexipan® è conforme alla regolamentazione europea e americana riguardante i materiali destinati al contatto con alimenti. Dal febbraio 1997 ha ottenuto la certificazione NSF®. Flexipan® ha ottenuto il riconoscimento da parte di FDA ed è approvato da LNE.

Altri prodotti e misure sono disponibili su richiesta.

Flexipan® is a combination of silicone and fiberglass designed for food use. This unique combination gives Flexipan® unequalled strength and durability, combined with exceptional non-stick properties. Heat resistant from -40°C to +280°C. Flexipan® has been granted NSF® International certification since February 1997. Approved by FDA (Food and Drug Administration-USA) and LNE.

Other products and sizes available on demand.



Mini-écrins

art.	mm.	h.	ml.	pcs
47740142	50x50	29	65	24



Mini-chenilles

art.	mm.	h.	ml.	pcs
47740143	102x40	36	90	27



Paesaggi - Landscapes

art.	ø mm.	h.	ml.	pcs
47740144	75	24	80	27



Crown muffins

art.	ø mm.	h.	ml.	pcs
47740-76	108/51	44	185	12



Little shells

art.	mm.	h.	ml.	pcs
47740-78	55x39	22	27	50



Oval savarins

art.	mm.	h.	ml.	pcs
47740-81	100x80	45	230	12



Little waves

art.	mm.	h.	ml.	pcs
47740121	79x49	25	76	24



Little cushion

art.	mm.	h.	ml.	pcs
47740-77	71x57	23	70	24



Scoop out

art.	mm.	h.	ml.	pcs
47740145	85x61	30	90	24



Lingotti/Porzione - Fluted ingots

art.	mm.	h.	ml.	pcs
47740127	106x46	25	90	24



Tavolette cioccolato - Chocolate bars

art.	mm.	h.	ml.	pcs
47740128	78x58	40	100	18



St Honoré - St Honoré crown

art.	ø mm.	h.	ml.	pcs
47740129	150	26	260	6



Esagoni - Hexagons

art.	ø mm.	h.	ml.	pcs
47740130	80	25	90	20



Mini St Honoré - Mini-St Honoré crown

art.	ø mm.	h.	ml.	pcs
47740131	80	20	70	18



Tartellette festonate - Fluted tartlets

art.	mm.	h.	ml.	pcs
47740132	78x78	20	70	24



Mini goccia - Mini drops

art.	mm.	h.	ml.	pcs
47740133	52x32	20	18	56



Campane - Bells

art.	mm.	h.	ml.	pcs
47740136	102x92	29	130	15



Pasticcini vari - Various petits-fours

art.	mm.	h.	ml.	pcs
47740134		22		60



Annapurna

art.	mm.	h.	ml.	pcs
47740137	495x40	33	370	5

Venduto con supporto inox. - Sold with stainless steel frame.



Uova - Eggs

art.	mm.	h.	ml.	pcs
47740135	94x60	31	95	25



Chenille - Caterpillar

art.	mm.	h.	ml.	pcs
47740138	495x40	36	450	5



Pesci - Fishes

art.	mm.	h.	ml.	pcs
47740139	99x59	25	100	18



Zaffiro savarin - Savarin zaphire

art.	mm.	h.	ml.	pcs
47740114	70x70	32	80	24



Zaffiro - Zaphire

art.	mm.	h.	ml.	pcs
47740112	40x40	24	17	54



Mini cuori - Small hearts

art.	mm.	h.	ml.	pcs
47740115	41x38	16	15	70



Zaffiro - Zaphire

art.	mm.	h.	ml.	pcs
47740113	70x70	35	75	24



Mini quadri - Small squares

art.	mm.	h.	ml.	pcs
47740116	37x37	17	18	60



Quadri - Squares

art.	mm.	h.	ml.	pcs
47740117	56x56	24	60	35



Cucchiaio - Spoon

art.	mm.	h.	ml.	pcs
47740118	90x28	12	15	36



Stelle - Stars

art.	mm.	h.	ml.	pcs
47740-88	80x65	15	35	24



Albero di Natale - Christmas tree

art.	mm.	h.	ml.	pcs
47740119	90x85	30	100	20



Lingotto - Ingot

art.	mm.	h.	ml.	pcs
47740122	120x40	25	100	24



Lingotto cavo - Hollow ingot

art.	mm.	h.	ml.	pcs
47740123	100x40	25	70	24
47740124	120x40	25	90	24



Semi cilindro - Half cylinder

art.	mm.	h.	ml.	pcs
47740125	85x17	15	20	48



Bavarese - Bavarois

art.	ø mm.	h.	ml.	pcs
47740105	78	35	100	18



Mini Charlotte

art.	ø mm.	h.	ml.	pcs
47740-82	35	15	9	60



Charlotte

art.	ø mm.	h.	ml.	pcs
47740-80	62	35	60	24



Charlotte

art.	ø mm.	h.	ml.	pcs
47740-23	78	40	100	18



Mini Madeleines

art.	mm.	h.	ml.	pcs
47740106	52x33	15	15	56



Madeleines

art.	mm.	h.	ml.	pcs
47740-17	78x47	19	35	40



Capesante - Shells

art.	mm.	h.	ml.	pcs
47740-79	80x75	20	70	24



Cuori - Hearts

art.	mm.	h.	ml.	pcs
47740-41	66x62	35	90	20



Cuori - Hearts

art.	mm.	h.	ml.	pcs
47740-89	75x65	35	81	20



Cuori intrecciati - Interlacing hearts

art.	mm.	h.	ml.	pcs
47740101	120x113	35	200	8



Mini cono - Small cones

art.	ø mm.	h.	ml.	pcs
47740-99	30	20	6	96



Inserto cono - Cone insert

art.	ø mm.	h.	ml.	pcs
47740102	50	40	24	40



Coni - Cones

art.	ø mm.	h.	ml.	pcs
47740103	70	60	80	20



Mini Savarin - Small Savarins

art.	mm.	h.	ml.	pcs
47740107	7x37	17	15	60



Savarin quadri - Square Savarins

art.	mm.	h.	ml.	pcs
47740108	56x56	24	45	35



Savarin quadri - Square Savarins

art.	mm.	h.	ml.	pcs
47740-96	70x70	30	100	24



Mini quadri - Small squares

art.	mm.	h.	ml.	pcs
47740109	45x45	12	20	60



Quadri - Squares

art.	mm.	h.	ml.	pcs
47740110	60x60	15	40	40



Mini piramidi - Small pyramids

art.	mm.	h.	ml.	pcs
47740-12	35x35	23	15	54



Piramidi fondo tronco - Pyramids flat bottom

art.	mm.	h.	ml.	pcs
47740-39	50x50	35	50	35



Piramidi - Pyramids

art.	mm.	h.	ml.	pcs
47740-13	71x71	41	90	24



Tronchetto natalizio - Christmas log

art.	mm.	h.	ml.	pcs
47740-26	95x40	30	80	24



Tronchetto natalizio - Christmas log

art.	mm.	h.	ml.	pcs
47740-27	122x42	32	115	24



Tronchetto natalizio - Christmas log

art.	mm.	h.	ml.	pcs
47740-28	339x40	39	450	8



Ceppo natalizio - Christmas log insert

art.	mm.	h.	ml.	pcs
47740-93	495x40	39	700	5



Savoardi - Champagne biscuits

art.	mm.	h.	ml.	pcs
47740-29	109x24	10	20	45

Venduto con supporto inox.
Sold with stainless steel frame.



Rettangoli - Rectangular cakes

art.	mm.	h.	ml.	pcs
47740-25	80x30	30	55	24



Rettangoli - Rectangular cakes

art.	mm.	h.	ml.	pcs
47740-24	89x46	25	110	25



Lingotto - Ingot

art.	mm.	h.	ml.	pcs
47740-94	102x58	30	139	18



Tartina festonata - Fluted cakes

art.	mm.	h.	ml.	pcs
47740-95	110x60	25	105	16



Mini financiers - Small financiers

art.	mm.	h.	ml.	pcs
47740-09	50x26	11	10	84



Finanzieri - Financiers

art.	mm.	h.	ml.	pcs
47740-10	86x46	14	45	24



Mini semisfera inversa - Small upside-down half sphere

art.	ø mm.	h.	ml.	pcs
47740-86	26	16	6	45



Mini semisfera - Small half sphere

art.	ø mm.	h.	ml.	pcs
47740-87	26	16	6	96



Mini semisfera - Small half sphere

art.	ø mm.	h.	ml.	pcs
47740-01	29	18	10	70



Semisfera - Half sphere

art.	ø mm.	h.	ml.	pcs
47740-02	42	21	20	48



Semisfera - Half sphere

art.	ø mm.	h.	ml.	pcs
47740-37	58	31	50	28



Semisfera - Half sphere

art.	ø mm.	h.	ml.	pcs
47740-03	70	40	105	24



Semisfera - Half sphere

art.	ø mm.	h.	ml.	pcs
47740-38	80	40	125	24



Mini savarin - Small savarins

art.	ø mm.	h.	ml.	pcs
47740-14	41	12	10	60



Savarin - Savarins

art.	ø mm.	h.	ml.	pcs
47740-20	66	20	50	35



Savarin - Savarins

art.	ø mm.	h.	ml.	pcs
47740-15	70	23	65	24



Fondi per crostate - Flan bases

art.	ø mm.	h.	ml.	pcs
47740-43	80	20	70	24



Orso - Teddy bear

art.	mm.	h.	ml.	pcs
47740-53	90x55	20	80	18



Mini savarin ovali - Small oval savarins

art.	mm.	h.	ml.	pcs
47740-98	40x30	12	9	60



Savarin ovali - Oval savarins

art.	mm.	h.	ml.	pcs
47740111	70x50	22	48	30



Savarin ovali - Oval savarins

art.	mm.	h.	ml.	pcs
47740-44	80x60	25	70	24



Esagono - Exagon

art.	mm.	h.	ml.	pcs
47740-83	45x40	12	12	60

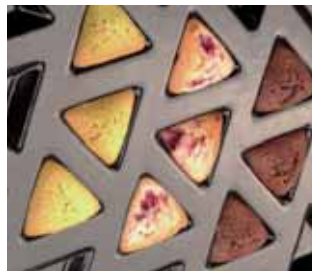

Triangoli - Triangles

art.	mm.	h.	ml.	pcs
47740-35	48x41	10	7	80



Ottagono - Optagon

art.	mm.	h.	ml.	pcs
47740-34	43x40	26	28	40



Losanghe - Rhombus

art.	mm.	h.	ml.	pcs
47740-36	60x35	10	9	70



Medaglioni - Medallions

art.	ø mm.	h.	ml.	pcs
47740-97	28	8	5	96



Pomponettes

art.	ø mm.	h.	ml.	pcs
47740-04	36	17	14	96



Medaglioni - Medallions

art.	ø mm.	h.	ml.	pcs
47740-50	38	10	14	54



Mini quiches - Small quiches

art.	ø mm.	h.	ml.	pcs
47740-33	40	20	22	54



Mini quiches - Small quiches

art.	ø mm.	h.	ml.	pcs
47740-07	42	10	13	60



Mini quiches - Small quiches

art.	ø mm.	h.	ml.	pcs
47740-08	48	15	20	48



Mini quiches - Small quiches

art.	ø mm.	h.	ml.	pcs
47740-84	58	20	35	40



Quiches

art.	ø mm.	h.	ml.	pcs
47740-30	77	20	65	24



Quiches

art.	ø mm.	h.	ml.	pcs
47740-85	96	25	135	15



Mini tartellette festonata - Small fluted tartlet

art.	mm.	h.	ml.	pcs
47740100	46x38	15	11	40



Mini tartellette ovale - Small oval tartlet

art.	mm.	h.	ml.	pcs
47740-31	66x27	11	10	48



Tartellette ovale - Oval tartlet

art.	mm.	h.	ml.	pcs
47740-32	106x45	15	35	30



Tagliapasta - Pastry cutter

art.	Adatto agli stampi:
47740-AA	07-08-34-31

Fits references: 07-08-34-31



Mini ovali - Small ovals

art.	mm.	h.	ml.	pcs
47740-11	51x31	20	20	50



Ovali - Ovals

art.	mm.	h.	ml.	pcs
47740-49	96x45	28	80	24



Mini quenelles - Small quenelles

art.	mm.	h.	ml.	pcs
47740-90	42x26	20	56	72



Mini ovali fondo piatto - Small ovals flat bottom

art.	mm.	h.	ml.	pcs
47740-91	57x35	12	18	64



Ovali - Ovals

art.	mm.	h.	ml.	pcs
47740-46	70x50	25	55	30
47740-47	70x50	30	75	30



Ovali - Ovals

art.	mm.	h.	ml.	pcs
47740-48	85x60	30	100	20



Quiches

art.	mm.	h.	ml.	pcs
47740-45	60x40	25	30	42



Mini cilindri - Small cylinders

art.	mm.	h.	ml.	pcs
47740-51	ø40	20	25	48



Cilindri - Cylinders

art.	ø mm.	h.	ml.	pcs
47740-52	63	25	65	24
47740-06	63	35	90	24



Muffins

art.	mm.	h.	ml.	pcs
47740-19	73	40	125	24
47740-68	79	36	115	24



Mini muffins - Small muffins

art.	ø mm.	h.	ml.	pcs
47740-67	51	29	45	40



Cilindri - Cylinders

art.	ø mm.	h.	ml.	pcs
47740-69	82	50	220	15
47740-70	91	35	190	15



Budini - Puddings

art.	mm.	h.	ml.	pcs
47740104	65	55	128	15



Tondo - Round

art.	ø mm.	h.	ml.	pcs
47740-63	125	16	75	11



Ovali - Ovals

art.	mm.	h.	ml.	pcs
47740-92	70x30	10	15	48



Ovali - Ovals

art.	mm.	h.	ml.	pcs
47740-55	130x48	18	80	24



Brioches tonde - Round brioches

art.	ø mm.	h.	ml.	pcs
47740-56	79	15	65	24



Brioches festonate - Fluted brioches

art.	mm.	h.	ml.	pcs
47740-57	62x49	26	60	24



Brioches festonate - Fluted brioches

art.	ø mm.	h.	ml.	pcs
47740-58	68	25	60	24
47740-59	78	30	105	24
47740-16	81	37	105	24



Biscotti - Cookies

art.	ø mm.	h.	ml.	pcs
47740-18	59	13	30	40
47740-60	78	10	50	24



Biscotti - Cookies

art.	ø mm.	h.	ml.	pcs
47740-61	91	8	60	15



Tarte tatin

art.	mm.	h.	ml.	pcs
47740-73	82	30	135	15



Quiches

art.	ø mm.	h.	ml.	pcs
47740-62	102	20	140	15



Quiches

art.	ø mm.	h.	ml.	pcs
47740-64	147	12	200	6
47740-65	150	15	250	6
47740-66	166	12	240	6



Quiches

art.	ø mm.	h.	ml.	pcs
47740-71	140	25	360	6
47740-72	150	24	390	6
47740-05	186	12	300	6



Biscotti - Cookies

art.	ø mm.	h.	ml.	pcs
47740-74	100	35	245	12
47740-75	105	40	305	12



Mezzo uovo - Half egg

art.	mm.	h.	ml.	pcs
47740140	55x35	20	20	56



Farfalla - Butterfly

art.	mm.	h.	ml.	pcs
47740141	70x60	20	60	24



Tagliapasta cucchiaino - Spoon pastry cutter

art.	47740-AB
------	----------



Tagliapasta a stella - Star pastry cutter

art.	47740-AC
------	----------



Tagliapasta cuore - Heart pastry cutter

art.	47740-AD
------	----------



Perle - Pearls

art.	ø mm.	h.	ml.	pcs
47743-65	73	40	100	15



Stelle - Stars

art.	mm.	h.	ml.	pcs
47741121	90x75	25	95	8



Tartelletta ovale - Oval tartlet

art.	mm.	h.	ml.	pcs
47741-32	106x45	15	35	15



Mini cuori - Small hearts

art.	mm.	h.	ml.	pcs
47741-78	52x49	10	15	30



Mini semisfera - Small half sphere

art.	ø mm.	h.	ml.	pcs
47741-76	23	11	5	63

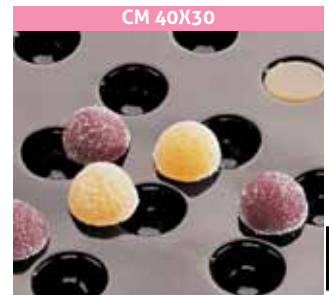

Semisfera piatta - Half sphere flat

art.	ø mm.	h.	ml.	pcs
47741-77	30	13	10	48

DEMARLE® 60x40 CM FLEXIPAT



Cilindro - Cylinder

art.	ø mm.	h.	ml.	pcs
47744-30	70	40	148	24



Cubo - Cube

art.	mm.	h.	ml.	pcs
47744-32	30x30	20	17	96



Kougloff

art.	ø mm.	h.	ml.	pcs
47744-31	80	54	150	24



Basic chic

art.	mm.	h.	ml.	pcs
47744-33	70x70	34	130	24



Diamante - Diamond

art.	ø mm.	h.	ml.	pcs
47744-34	79	40	100	24



Flexipan desserts

art.	mm.	h.	GN
47744-48	480x280	13	1/1
47744-60	555x360	10	
47744-62	555x360	20	



Rosette

art.	ø mm.
47744-10	240

Venetian cane

art.	mm.
47744-19	555x360

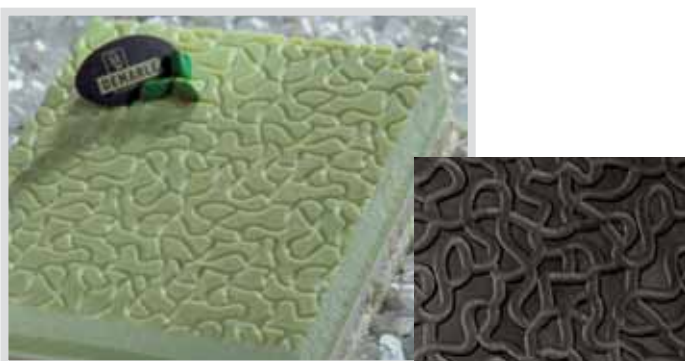

Labyrinth

art.	mm.
47744-21	600x400

Snowflake

art.	mm.
47744-63	240



BIGNE' - PUFFS - WINDBEUTEL - CHOUX - BOLLOS

Supporto alveolare Silform® per cottura di pasta bigné.

Questa gamma è stata sviluppata in particolare per la pasta di bigné. Grazie alle impronte preformate, preparare bigné uguali e regolari diventa facile. Non è più indispensabile né spennellare con tuorlo né forare la pasta. Grazie alle proprietà antiaderenti del Silform®, l'estrazione è impeccabile. La base del bigné sarà chiara e netta conferendogli così una perfetta stabilità. Silform® for Choux Pastry.

This range has been developed especially for cream puffs dough.

The pre-formed shapes make easy obtaining perfect, regular and same size cream puffs. Neither greasing the sheet nor spiking the dough is required before baking. The non-stick property of the material allows an easy and perfect extraction of the pastries. The base of the puff will be clear and plain for a perfect stability.



Mini-éclairs

art.	mm.	h.	ml.	pcs
41760-25	70x30	10	15	48



Baby choux

art.	ø mm.	h.	ml.	pcs
41760-22	30	5	4	59



Oval choux

art.	mm.	h.	ml.	pcs
41760-26	90x60	15	56	25



Big choux

art.	mm.	h.	ml.	pcs
41759-01	67	15	48	28



Eclairs

art.	mm.	h.	ml.	pcs	
41760-20	125x25	5	15	18	right handed
41760-21	125x25	5	15	18	left-handed



Paris-Brest

art.	ø mm.	h.	ml.	pcs
41760-27	80	15	50	24

INDICE ALFABETICO
ALPHABETICAL INDEX
ALPHABETISCH INDEX
TABLE DES MATIERES
INDICE ALFABETICO

A					
	pag.				
Adattatore Per Bocchette	422	Carrello Di Servizio	228, 229	Contenitore, Pe	217
Affetta Pomodori	80	Carrello Di Servizio/Porta Biancheria	232, 233, 240	Contenitore, Polipropilene	214
Affettatrice	154	Carrello Lavapavimento	240, 241	Coperchio Roll-Top	329, 361, 366
Ago Da Cucina	196	Carrello Per Ceste Bicchieri	211	Coperchio, Alluminio	17
Alzata Ceste Pane	174, 175	Carrello Per Derrate Alimentari	216	Coperchio, Inox	4, 7, 12
Alzata Dolci	249, 317	Carrello Per Rifornimento Frigobar	230	Coperchio, Rame	24, 26
Alzata Frutta	375	Carrello Per Slim Jim	237	Coppa Burro	279, 280
Alzata Torta	329, 330, 376, 377, 379	Carrello Porta Piatti	212, 225, 226	Coppa Caviale	288
Alzata/Supporto, Cromato	345, 365	Carrello Porta Teglie	227, 228	Coppa Punch	377, 387
Alzatina Per Buffet	355	Carrello Portavassoio	230	Coppa Riso	123
Anelli Per Torte	438 >440	Carrello Termico	225 >227	Coppa Soufflè	30, 39, 280
Anelli Per Uova	84	Carrello Vuoti, Pp	242	Coprimanico Silicene	22, 32
Anello Portabottiglie/Bicchieri	377	Carta Da Forno	437	Copriscarpe	205
Antipastiera	342, 343	Cartello Ammonitore	235	Cornetto Cinese	78
Apparecchi Elettrici	136 >158	Cascata Champagne	378	Couscoussiera	17
Apribottiglie/Levacapsule	109, 115, 327	Casseruola Per Zabaione	24	Cover Monouso, Bobina	71
Apriscatole	96, 98, 109, 115	Casseruola Per Zucchero	24	Cremiera	247
Ardesia Naturale	274, 275	Casseruola Terracotta	131	Crepiera	137
Arricciaburro	81, 113	Cavatappi	327, 328	Cucchiaino Bibita	270
Aspirapolvere Meccanico	234	Centrifuga Per Insalata	77	Cucchiaino Brodo	124
Atlantic Buffet System	385 >389	Cesta Pane Impilabile, Polietilene	170	Cucchiaino Decorazione	89
B					
	pag.				
Bacchette Cinesi	126, 132	Cesta Per Friggere	22, 44	Cucchiaino Gourmet, Inox	354
Bacinella	74, 76, 77	Cestelli Lavabicchieri	209, 210	Cucchiaino Magico	320
Bacinella Gelato	312	Cesti E Contenitori, Pp	216, 217	Cucchiaino Melamina	123, 348
Bagnomaria	14, 20, 25, 158	Cestino Agrumi	318	Cucchiaino Misuratore Volumetrico Digitale	103
Barra Magnetica	194	Cestino Impasto	170	Cucchiaino Riso	128
Batticarne	197	Cestino Rifiuti	236 >243	Cucchiaino, San	348
Benna	238	Cesto Gastronorm, Pp	217	Cucchiaino A Servire, Melamina	123
Bicchiere Shaker	321, 322	Cesto Pane	171 >178, 247, 281	Cucchiaino Legno	68
Bicchieri	212, 336 >338	Cesto Uova	175	Cucchiaino Unipezzo	65
Bilancia	104, 105	Chafing-Dish	387, 390, 392	Cucchiaino, Pa+	57 >59
Bocchette	418 >425	Chiodi Per Fiori	423	Cucchiaino, Pc	61
Bollitore	15	Chitarra	432	Cuffia, Tnt	205
Bollitore Uova	140	Ciotola Refrigerata	364, 368	Cuoci Riso	157
Bordatore Bicchieri	324	Ciotola, Inox	361	Cuoci Uovo	71
Borsa Termica	164	Ciotola, Melamina	121 >123, 279, 347, 348, 351, 352, 361	Cuociasparagi	9
Bottiglia Per Bagne	436	Ciotola, Pc	213	Cuocivapore	128, 130
Box Per Ciotole	362, 363	Ciotola, Vetro	361		
Box Termico	226	Clip Reggibicchiera	340	D	pag.
Brasiera	14, 20	Cloche/Copripiatto	72, 249, 286, 329, 330, 366	Dash Bottle	322
Brocca Acqua, Inox	247	Cocktail Master	324	Deba	134
Bruschino Per Bocchette	423	Cocotte Per Molluschi	286	Diffusore Per Ambienti	232
C					
	pag.				
Caffettiera	247, 272	Colapasta	60, 74, 75, 77, 78	Disidratatore	153
Caffettiera Elettrica	395	Colapasta A Spicchi	3, 9, 15, 17	Dispenser Autofoam	232
Caffettiera Pressa Filtro	272	Colatutto	60	Display Per Buffet	352 >354
Campanella Reception	294	Colino Cocktail	320	Distributore Di Cereali	373, 374
Candeliere	291	Colonna Luminosa	287	Distributore Di Latte	373, 374
Cannello	383	Coltelli	180 >195	Distributore Di Succhi	364, 374, 375
Cappello Cuoco	202, 205	Coltello Per Marzapane	431	Distributore Panini	365
Caraffa	125, 247, 272, 273, 371, 372	Compatta-Bottiglie	96	Distributore Termico, Inox	375
Caraffa Graduata	72, 73	Compressore Per Penna Aerografa	430	Dosatore	331
Caraffa Termica	247, 272, 375	Cono Boston Con Fondello	321	Dosatore Miele	316
Caramellizzatore	157, 429	Contenitore A Doppia Parete, Inox	365	Dosatore Soia	124
Carrelli Sala	398 >402	Contenitore Con Coperchio	217	Dosatrice Per Creme	429
Carrello	211, 222, 229, 230	Contenitore Di Riserva	323		
Carrello Con Guide Gn	227	Contenitore Isotermico	165, 220 >225	E	pag.
		Contenitore Per Alimenti	215, 216	Elemento Elettrico	385, 387
		Contenitore Per Uova	83	Espositore Caldo	140
		Contenitore Rifiuti	236 >243	Espositore Cereali	364, 369 >371
		Contenitore Sovrapponibile, Hdpe	218, 219, 229	Espositore Porta Ciotole	370 >372
		Contenitore Universale, Impilabile	329	Espositore Sacchetti/Bocchette	427
		Contenitore Versatore	323	Estrattore	451

Eutettico	222, 221, 362	Legatovagliolo	283	Pennello	81, 113, 435
F	pag.	Levafiori	423	Pentola A Pressione	10
Falso Fondo Forato	44	Levatorsoli	81, 113	Pentola Cinese	130
Fasciatoio	238	Libro 'Scolpire Frutta E Verdura'	89	Pentolame, Alluminio	16 >20
Ferma Prosciutto	198	Lira	86, 430	Pentolame, Ghisa	29 >37
Fermatovaglia	283	MNO	pag.	Pentolame, Inox	2 >15
Fingerfood	347, 348	Macchina Per Cialde	142	Pentolame, Rame	23 >26
Flacone Dosatore	331	Macchina Sottovuoto	158	Pesa Sciroppo	430
Flair Bottle	323	Macelleria, Accessori	195 >200	Pesciera	14, 20, 24
Flexipan	466 >476	Macina Pepe/Sale	298 >305	Pestaghiaccio	319
Flexipat	475	Mandolino	85 >87	Pettine	448
Foil Cutter	327	Mantecatore	91	Peugeot	298 >305
Fonduta	25, 285	Mascherine Spargicacao	316	Piano Caldo	156
Fontana Cocktails	378	Mestolo Sangria	61	Piastra	137
Forbice	85, 163, 267	Mestolo Unipezzo	65	Piastra Refrigerante	222, 221, 362
Forbici Per Servire	267 >270	Mestolo, Pa+	58, 59	Piastre Induzione	155, 156, 386
Forchettine Marzapane	431	Miniature	25, 28, 30	Piattino Pane	248
Forchettine Pralineria	431	Misuratore Di Salinità	103	Piatto Girevole	275
Forchettone Unipezzo	66	Misurino Cocktail	320	Piatto Grigliante	71
Formaggiaria	283	Mixer	143, 144	Piatto Lumache	288
Fornello Crêpes Suzettes	285	Modulo Per Ciotole	361	Piatto Presentazione	249
Fornello Gas	140	Molla Per Grill	69	Piatto Torta	329, 356, 437
Forni E Microonde	138, 139, 155	Molla Per Servire	267 >270	Piatto, Melamina	121 >124
Friggitrici	141	Molla, Pa+	58	Piatto, Pc	213
Frullatori	143 >152	Molla, Pc	61	Pietanziera	224
Frusta	60	Monouso	311, 340, 341	Pinza Aragosta	287
G	pag.	Mop	234, 235, 241	Pinza Togli Lische	69
Gancio	197	Mortaio E Pestello	131	Pinzetta Decoro	417
Gastronorm, Induzione	53	Nastro/Fogli Acetato	437	Piramide, Inox	354
Gastronorm, Inox	41 >43	Noccioli Di Cottura	437	Pirofile Forno, Porcellana	39
Gastronorm, Melamina	51	Oliera	131, 160	Pistola Elettrica	429
Gastronorm, Policarbonato	45, 46	Orologio Da Parete	103	Pittogrammi	293
Gastronorm, Polipropilene	48 >50	Oroshi	134	Pizzi Sottotorta	427
Gastronorm, Porcellana	52, 53	PQR	pag.	Placca Per Pastafrolla	449
Gastronorm, Tritan	47	Padella Balti/Karahi	129	Plancia, Legno	30, 31
Gel Combustibile	393	Padella Tawa	130	Plancia, Melamina	276 >279
Giacca Cuoco	202	Padella Toban	125	Plancia, Poliestere	276 >278
Girello Torte	427	Padella, Alluminio	17, 19, 28	Pompa Sottovuoto Per Vino	290
Glacette Termica	288, 289, 361, 364	Padella, Antiaderente	4, 12, 18	Pompetta Per Sugo	69
Grattugia	85, 93, 94, 115, 132	Padella, Ferro	21, 22	Pompetta Zucchero	431
Grembiule	201, 202, 205	Padella, Inox	4, 7, 12	Porcellana Arthur Krupp	252 >259
Griglia Di Colaggio	427	Padella, Rame	24, 26	Porta Cannucce	248
Griglia Forno Smaltata	44	Pala Per Patate Fritte	68	Porta Coltelli	194
Griglia In Filo	44, 428	Pala Per Torte	427	Porta Cucchiaini	248
Griglia Kebab/Gyros	137	Pala Per Torte	427	Porta Menù	292
Griglia Per Decoro Biscuit	449, 450	Pale Pizza e Accessori	160 >166	Porta Oggetti Da Bar	320
Griglia Per Tempura	129	Paletta Raccogli Rifiuti	234, 242	Porta Olio/Aceto	249
Grill A Contatto	136	Paletta Unipezzo	66	Porta Panini	328
Guanti	203, 204	Paletta, Pa+	57 >60	Porta Piatti In Filo	212
IKL	pag.	Pallet, Pe-Hd	217	Porta Yogurt Refrigerato	368
Imbuto	72	Panno Microfibra	235	Portabustine Zucchero	248, 317
Imbuto Colatore	429	Panno Passabrodo	78	Portacandela	292
Insalatiera	280, 281, 349, 350	Pantaloni Cuoco	202	Portacombustibile	387
Kit Visitatore	205	Passapomodori	96, 97	Portacondimenti	321
Laccetti Da Cucina	196	Passathé	273	Portacondimenti	89
Lampada Ad Infrarossi	396	Pattumiera A Pedale	236 >243	Portagrassini	281
Lampada Per Zucchero	430	Pedana	229, 243	Portamarmellata	249
Lattiera	247, 248	Pelamele	82, 85	Portapaté	279
Lavamani Autonomo	195	Pelapatate	81, 84, 113	Portaposate	210, 281, 282, 363, 364
		Pelaverdure	81, 84	Portarifiuti Da Tavola	286
		Penna Aerografa	430	Portasalatini	342, 343, 348
				Portascontrini	70

Portasecchiello	288	Setaccio	73, 74, 436	Tagliere	124, 199, 200, 277, 361
Portatoast	274	Sfogliatrice	94	Tako Sashimi	134
Portatovaglioli	248, 317	Shaker	322	Tampone Finto Legno	448
Portauovo	274	Sifone Panna	313, 314	Tappetino Bar	321
Porzionatore Gelato	312	Sifone Soda	316	Tappeto Silicone	437, 438
Posacenera A Colonna	238, 243	Silform	477	Tappo Dosatore	325
Posacenera Da Tavola	295	Silpain	438	Tappo Metrico	326
Posate Caviale, Madreperla	288	Silpat	438	Tappo Spumante/Vino	326, 327
Posateria Arthur Krupp	261 >265	Siringa Per Pasticceria	426	Tappo Versatore	326
Poster 'La Cuisine'	89	Snocciolatore	86	Tastevin	290
Pressa-Hamburger	198	Sottobicchiere	249	Tazza, Pc	213
Pressapolipo	79	Sottobottiglia	249	Tegame Rettangolare	19, 13, 20, 24
Presse Canard	78	Spargicacao	316	Teglia Alluminio	428
Pulse, Sistema Di Pulizia	234	Spargiformaggio	283	Teglia Gn Smaltata	44
Quick Cart Caddy	232	Spargisale/Pepe	282, 283	Teglia Monoporzioni	451
Raccoglibriciolo	286	Spargizucchero	316, 436	Teglia Pizza	165 >167
Raschietti	436	Spatola Gelato	312	Teglia Siliconata	428
Rastrelliera	70	Spatola Legno	68	Teiera	247
Rechaud	285	Spatola Pa+	57	Telaio X-Cart	232
Recipiente Multiuso, Pp	212	Spatola Per Biscuit	431	Temperatrice	429
Reggi Caramellometro	431	Spatole Inox Con Manico Polipropilene	62, 63	Termometro	100 >103
Retine Pizza	164, 166	Spatolina	269	Termometro Vino	290
Riga	431	Spazzole Lavabicchieri	324	Termoregolatore	387
Robot Multifunzione	145 >147	Specchi Acrilico	357	Tester Oli Di Frittura	103
Rompighiaccio	319	Spiedini	126, 196, 340	Timer	102, 103
Rompinoci	286	Spremiaglio	86	Tostapane	139
Rotella Taglia Pasta	107, 114, 433	Spremiagrumi	149, 152, 318	Totem Per Padelle	22
Roul'Pat	438	Spremilimone	318	Tovaglette	283
Rullo	433 >435	Squamapesce	81, 113	Tritacarne	154
Runner	283	Stampi Cioccolato	452 >460	Tritaghiaccio	152, 319
S	pag.	Stampi Flexipan	466 >476	Utensili Per Decorazione	80, 81, 84, 87 >89
Sacchetto Per Decorare	425 >426	Stampi Gelatine	461	Usaba	134
Salamandra	139	Stampi, Alluminio	441	Utensili A Servire, Serie Living	267 >270
Salsiera	280	Stampi, Antiaderenti	443 >448	Utensili Cucina	107 >119
Samovar	394	Stampi, Silicone	452, 459 >476	VWYZ	pag.
Scalda Würstel	137	Stampo Gelato	313	Valigia Barman	325
Scaldaburro	25	Stampo Pane	169	Vasi Gourmet	276, 346
Scaldacaffé	391, 395	Stampo Ravioli	94	Vaso Fiori	292
Scaldacognac	290	Stampo Sfere Ghiaccio	319	Vaso Porta Sacchetto	425
Scaldapiatti	140	Stampo Sushi	127	Vassoi	333 >335
Scaldasalse	140	Stand Per Vassoi	334	Vassoietto Party	340
Scalpello Ghiaccio	383	Stencil	451	Vassoio Conto	249
Scatola Portabustine Thè	394	Stendipasta	431	Vassoio Espositore	356, 437
Scavino	81, 113	Sterminatore Elettrico	158	Vassoio Frutti Di Mare	287
Schiumarola A Rete	67, 68, 132	Stiletto Tailandese	84	Vassoio Gn 1/1	347
Schiumarola Unipezzo	66	Stuoietta Sushi	127	Vassoio Isotermico	212
Schiumarola, Pa+	58, 59	Stuzzicadenti	340	Vassoio, Ecologico	335
Scolapiatti Da Muro	212	Supporto Bottiglie	325	Vassoio, Inox	250, 317, 358, 359, 361
Scopa	234, 242	Sushi Bridge	125	Vassoio, Melamina	121 >123, 178, 346
Secchio	75, 76, 241	Svuota Ananas	81	Vetrina Antipasti	127
Secchio Vino	288, 289	TU	pag.	Vetrina Da Banco	328, 329
Secchio Con Strizzatore	241	Taglia Croissant	434	Vetrina Refrigerata	329, 361, 367, 368
Secchio Ghiaccio	319, 320	Taglia Pane	365	Vetrina Sigari	294
Sedile Di Sicurezza Per Bambini	238	Taglia Patate	84	Wok	12, 22, 128, 129
Sega Per Ossa	197	Taglia Uova	83	Yanagi Sashimi	134
Seggiolone	239	Tagliapasta, Inox	90, 91, 407 >415, 417	Zuccheriera	247
Segnaporzioni Per Torte	434	Tagliapasta, Pa+	416	Zuppiera	123, 280
Senapiera	279	Tagliasfoglia	94	Zuppiera Elettrica	396
Servizio Oliera	283	Tagliasigari	294		
Servizio Raclette	286	Tagliatartufi	281		
Sessola	61, 73	Tagliaverdure	81, 83, 84, 88, 89		

A	pag.				
Acetate Roll/Sheets	437	Butcher Accessories	195 >200	Cookware, Pots & Pans, Aluminum	16 >20
Airbrush	430	Butter Churn	91	Cookware, Pots & Pans, Cast Iron	29 >37
Almont Past Knife	431	Butter Cup	279, 280	Cookware, Pots & Pans, Copper	23 >26
Aluminium Baking Tray	428	Butter Curler	81, 113	Cookware, Pots & Pans, Stainless Steel	2 >15
Appetizer Tray	342, 343	Butter Warmer	25	Cool Bowl	364, 368
Apple Corer	81, 113	C	pag.	Cooled Showcase	329, 361, 367, 368
Apple Peeler	82, 85	Cake Marker	434	Cooled Yogurt Dispenser	368
Apron	201, 202, 205	Cake Peel	427	Corkscrew	327, 328
Ashtray	295	Cake Plate, Swivel Base	427	Couscous Pan	17
Asparagus-Pot	9	Cake Stand	329, 330, 376, 377, 379	Cover, Aluminum	17
Atlantic Buffet System	385 >389	Cake Tray	329, 356, 437	Cover, Copper	24, 26
Autofoam Dispenser	232	Can Opener	96, 98, 109, 115	Cover, Stainless Steel	4, 7, 12
B	pag.	Candle Stick	291	Cream Dispenser	429
Bain-Marie	14, 20, 25, 158	Cap, Tnt	205	Cream Injector	429
Baking Beans	437	Caramelizer	157, 429	Cream Whipper	313, 314
Baking Paper	437	Cash Tray	249	Creamer	247
Baking Sheet Trolley	227, 228	Caviar Cooler	288	Crepe Machine	137
Balloon Whisk	60	Caviar Flatware, Mother Of Pearl	288	Croissant Cutter	434
Balti Pan	129	Cereal Dispenser	373, 374	Crumb Scraper	286
Bar Mat	321	Cereal-Bar	364, 369 >371	Cup, Pc	213
Bar Organizer	320	Chafing Dish	387, 390, 392	Cutlery Dispenser	210, 281, 282, 363, 364
Barman'S Set	325	Champagne Waterfall	378	Cutters, Stainless Steel	90, 91, 407 >415, 417
Baster Tube	69	Champagne/Wine Stopper	326, 327	Cutting Board	124, 199, 200, 277, 361
Basting Spoon, One Piece	65	Changing Table	238	Cutting Roller	94
Bins And Containers, Pp	216, 217	Cheese Jar	283	DEF	pag.
Biscuit Spatula	431	Cheese Shaker	283	Dash Bottle	322
Blenders	143 >152	Chef Hat	202, 205	Deba	134
Bone-Saw	197	Chef Jacket	202	Decorating Spoons	89
Boston Cone	321	Chef Trousers	202	Decorating Tools	80, 81, 84, 87 >89
Bottle Cooler	288, 289, 361, 364	Chef'S Torch	383	Dehydrator	153
Bottle For Rum Spraying	436	Child Safety Seat	238	Diasposable Covers	71
Bottle Opener	109, 115, 327	Chinese Colander	78	Digital Volumetric Spoon Scale	103
Bottle Rack	325	Chinese Hot Pot	130	Dipping Forks	431
Bottle Saucer	249	Chocolate Molds	452 >460	Dish Caddy	212
Bottle Trolley, Pp	242	Chocolate Warmer	140	Dish Trolley	212, 225, 226
Bottle/Glass Ring Insert	377	Chopsticks	126, 132	Dish-Warmer	140
Bottle-Crasher	96	Cigar Cutter	294	Dishwasher Racks	209, 210
Bouillon Cloth	78	Cigar Humidor	294	Dispenser	331
Bowl Boxes	362, 363	Citrus Fruit Squeezer	149, 152, 318	Dispenser Plug	325
Bowl Module	361	Clay Pot	131	Display Tray	356, 437
Bowl, Glass	361	Cocktail Fountain	378	Disposables	311, 340, 341
Bowl, Melamine	121 >123, 279, 347, 348, 351, 352, 361	Cocktail Master	324	Doilies	427
Bowl, Pc	213	Cocktail Measuring Cup	320	Dolly	211, 222, 229, 230
Bowl, Stainless Steel	361	Cocktail Shaker	322	Dome Cover	72, 249, 286, 329, 330, 366
Box, Polypropylene	214	Cocktail Strainer	320	Dough Scrapers	436
Bread Basket	171 >178, 247, 281	Cocoa Dredger	316	Drainer Plate	44
Bread Basket Stand	174, 175	Cocoa Stensils	316	Draining Rack	427
Bread Basket, Stackable, Lldpe	170	Coffee Maker, Electric	395	Dressing Pot	365
Bread Dish	248	Coffee Pot	247, 272	Dunnage Rack/Footboard	229, 243
Bread Mould	169	Coffee Urn	391, 395	Dust Beater	234, 242
Bread Proofing Basket	170	Cognac Warmer	290	Dustpan	234, 242
Bread Roll-Dispenser	365	Colander	60	Egg Basket	175
Bread Slicer	365	Collapsible Frame	232	Egg Boiler	140
Breadstick Basket	281	Comb	448	Egg Container	83
Bucket	75, 76, 241	Condiment Holder	321	Egg Cooker	71
Bucket With Wringer	241	Condiment Set	283	Egg Cup	274
Buffet Display	352 >354	Confectionery Funnel	429	Egg Rings	84
Buffet Ladder	370 >372	Contact Grill	136	Egg Slicer	83
Buffet Stand	355	Container, Pe	217	Electric Appliances	136 >158
		Cookie Press And Icing Set	426	Escargot Dish	288
		Cooking Oils Tester	103	Eutectic Pad	222, 221, 362

Extractor	451	Guitar	432	Meat Tenderizer	197
Fingerfood	347, 348	HIJKL	pag.	Mechanical Sweeper	234
Fish Kettle	14, 20, 24			Melon Baller	81, 113
Fish Scaler	81, 113	Ham Stand	198	Menu Stand	292
Fish-Bone Remover	69	Hamburger Press	198	Mesh Skimmer	67, 68, 132
Flair Bottle	323	Hand Wash Basin	195	Metric Pourer	326
Flambé Burner	285	Heating Unit	385, 387	Microburst Duet	232
Flatware, Arthur Krupp	261 >265	Honey/Cream Dispenser	316	Microfibre Cloth	235
Flexipan Molds	466 >476	Hot Dog Heater	137	Milk Dispenser	373, 374
Flexipat	475	Housekeeping Cart	232, 233, 240	Milk Pot	247, 248
Floor Cleaning Trolley	240, 241	Ice Balls Mold	319	Mills Pepper/Salt	298 >305
Floor Standing Ashtray	238, 243	Ice Beater	319	Miniatures	25, 28, 30
Flour Scoop	61, 73	Ice Bucket	319, 320	Mirror, Acrylic	357
Flower Lifter	423	Ice Chisel	383	Mitts	203, 204
Flower Nails	423	Ice Cream Container	312	Mixing Bowl	76, 77
Flower Vase	292	Ice Cream Mold	313	Mixing Glass	321, 322
Foil Cutter	327	Ice Cream Scoop	312	Monoportion Tray Mould	451
Fondue Set	25, 285	Ice Crusher	152, 319	Mop	234, 235, 241
Food Canister	224	Ice Dipper	312	Mortar And Pestle	131
Food Container	215, 216	Ice Pick	319	Multipurpose Box, Pp	212
Food Processors	145 >147	Ice Tea Spoon	270	Mussel Pot	286
Free Flow Pourer	326	Icing Bag	425 >426	Mustard Cup	279
French Fry Cutter	84	Icing Bag Holder	425	Napkin Holder	248, 317
French Fry Scoop	68	Icing Bags/Nozzles Wall Rack	427	Napkin Ring	283
French Press	272	Immersion Blenders	143, 144	Newspaper Stick	89
Fruit Basket	318	Induction Hobs	155, 156, 386	Nut-Cracker	286
Fruit Stand	375	Infrared Lamp	396	Octopus-Press	79
Fry Basket	22, 44	Insect Killer	158	Oil And Winegar Stand	249
Fryers	141	Insulated Beverage Server	247, 272, 375	Oil Pourer	131, 160
Frypan Stand	22	Insulated Box	165, 220 >225	Oroshi	134
Frypan, Aluminum	17, 19, 28	Insulated Dispenser	375	Oven Cooking Dish, Porcelain	39
Frypan, Copper	24, 26	Isothermic Tray	212	Oven Grid Enamelled	44
Frypan, Non Stick Coating	4, 12, 18	Jam/Honey Stand	249	Ovens & Micro-Waves	138, 139, 155
Frypan, Stainless Steel	4, 7, 12	Jelly Fuel	393	Overshoes	205
Frypan, Steel	21, 22	Jelly Molds	461	Oyster Tray	287
Fuel Holder	387	Jug	125, 247, 272, 273, 371, 372	PQR	pag.
Funnel	72	Juice Dispenser	364, 374, 375	Pallet	217
G	pag.	Kebab/Gyros Grill	137	Party Spoon, Stainless Steel	354
Garlic Press	86	Kitchen Strings	196	Party Tray	340
Gas Stove	140	Kitchen Utensils	107 >119	Pasta Machine	94
Gastronorm Basket, Pp	217	Kitchenbowl	74, 76, 77	Pastry Brush	81, 113, 435
Gastronorm Food Pans, Induction	53	Knife Rack	194	Pastry Cutters, Pa+	416
Gastronorm Food Pans, Melamine	51	Knives And Accessories	180 >195	Pastry Molds, Aluminum	441
Gastronorm Food Pans, Polycarbonate	45, 46	Lacing Needle	196	Pastry Molds, Non-Stick	443 >448
Gastronorm Food Pans, Polypropylene	48 >50	Ladle, One Piece	65	Pastry Molds, Silicone	452, 459 >476
Gastronorm Food Pans, Porcelain	52, 53	Ladle, Pa+	58, 59	Pastry Stand	249, 317
Gastronorm Food Pans, Stainless Steel	41 >43	Lemon Squeezer	318	Pastry Tube Brush	423
Gastronorm Food Pans, Tritan	47	Lightning Column	287	Pastry Wheel	107, 114, 433
Glass Cleaning Brush	324	Lobster Cracker	287	Paté Cup	279
Glass Clip Holder	340	MNO	pag.	Pedal Bin	236 >243
Glass Rimmer	324	Magic Spoon Whisks	320	Peugeot	298 > 305
Glass Saucer	249	Magnetic Knife Rack	194	Pineapple Coring Tool	81
Gn Pan, Enamelled	44	Mandoline	85 >87	Piping Tip Adapter	422
Gn Rail Trolleys	227	Marzipan Nipper	417	Pizza Delivery Bag	164
Gourmet Glasses	276, 346	Marzipan Set	431	Pizza Peels And Accessories	160 >166
Grater	85, 93, 94, 115, 132	Mayomaker	91	Pizza Screens	164, 166
Gravy Boat With Foot	280	Measuring Jug	72, 73	Pizza Sheets	165 >167
Griddle Plate	137	Meat Dish, Stainless Steel	250, 317, 358, 359, 361	Place Mats	283
Grill For Biscuit	449, 450	Meat Fork, One Piece	66	Plate Warmer	285
Grill Tweezer	69	Meat Hook	197	Plate, Melamine	121 >124
Grilling Plate	71	Meat Mincer	154	Plate, Pc	213

ALPHABETICAL INDEX ENGLISH

Porcelain, Arthur Krupp	252 >259	Soufflé Pot	30, 39, 280	Toast Rack	274
Poster 'La Cuisine'	89	Soup Bowl	123, 280	Toaster	139
Potato Peeler	81, 84, 113	Soup Spoon	124	Toban Skillet	125
Pouring Container	323	Soup Strainer	60	Tomato Cutter	80
Presse Canard	78	Soup Warmer	396	Tomato Juicer Sieve	96, 97
Pressure Cooker	10	Soy Pot	124	Tong, Pa+	58
Pulse, Cleaning System	234	Space Saving Box With Cover	217	Tong, Pc	61
Punch Bowl	377, 387	Spatula, One Piece	66	Toothpicks	340
Pyramid, Stainless Steel	354	Spatula, Pa+	57 >60	Tray Gn 1/1	347
Quick Cart	232	Speed Rack	70	Tray Serving Trolley	230
Raclette Cheese Sevice	286	Spits	126, 196, 340	Tray Stand	334
Ravioli Mould	94	Spoon Holder	248	Tray, Environmentally Friendly	335
Reception Bell	294	Spoon, Melamine	123, 348	Tray, Melamine	121 >123, 178, 346
Revolving Platter	275	Spoon, Pa+	57 >59	Tray, Silicone Coated	428
Rice Bowl	123	Spoon, Pc	61	Tray, Stainless Steel	250, 317, 358, 359, 361
Rice Spoon	128	Spoon, San	348	Trays	333 >335
Rice Steamer	157	Spray Gun	429	Trolley For Dishwasher Racks	211
Roasting Pan	13, 19, 24	Spreader	269	Trolley For Restocking Refrigerators	230
Rolling Pin	433 >435	Squeeze Bottle	331	Trolleys	398 >402
Roll-Top Cover	329, 361, 366	Stackable Container, Hdpe	218, 219, 229	Truffle Slicer	281
Roul'Pat	438	Steamer	128, 130	Tubes	418 >425
Ruler	431	Stencil	451	Tumblers	212, 336 >338
Runner	283	Stencil-Mat	449	Turners S/S With Polypropylene Handle	62, 63

S

pag.

Salad Bowl	280, 281, 349, 350	Stirring Ladle, Pa+	57	Usuba	134
Salad Spinner	77	Storage Canister	323		
Salamander	139	Storage Container Trolley	216		
Salt Tester	103	Strainer	60, 74, 75, 77, 78		
Salt/Pepper Shaker	282, 283	Straw Holder	248		
Samovar	394	Sturdy Chair	239		
Sandwich Case	328	Sugar Bags Holder	248, 317		
Sangria Ladle	61	Sugar Bowl	247		
Scales	104, 105	Sugar Bulb	431		
Scissors	85, 163, 267	Sugar Lamp	430		
Seed Remover	86	Sugar Pourer	316, 436		
Segment Colander	3, 9, 15, 17	Sugar Saucepan	24		
Serving Board, Melamine	276, 277, 278, 279	Sugar Thermometer Holder	431		
Serving Board, Polyester	276, 277, 278	Sushi Bridge	125		
Serving Items, Series Living	267 >270	Sushi Mat	127		
Serving Pliers	267 >270	Sushi Mold	127		
Serving Spoon, Melamine	123	Sweet Box, Stackable	329		
Serving Stand, Chrome Plated	345, 365	Syrup Density Meter	430		
Serving Tongs	267 >270				
Serving Trolley	228, 229				
Show Plate	249				
Showcase	328, 329				
Sieve	73, 74, 436				
Sign Plates	293				
Silform	477				
Silicone Baking Sheet	437, 438				
Silicone Sleeve	22, 32				
Silpain	438				
Silpat	438				
Skimmer, One Piece	66				
Skimmer, Pa+	58, 59				
Slate, Natural	274, 275				
Slicing Machine	154				
Slim Jim Dolly	237				
Smoothen	431				
Snack Holder	342, 343, 348				
Soda Siphon	316				

TU

pag.

Tab-Grabber	70	Usuba	134
Table Garbage Bin	286		
Table-Cloth Clips	283		
Tako Sashimi	134		
Tapas Display	127		
Tart Ring, Stainless Steel	438 >440		
Tawa Pan	130		
Tea Pot	247		
Tea Strainer	273		
Tea-Box	394		
Tempering Unit	429		
Tempura Rack	129		
Thai Knife	84		
Thermic Box	226		
Thermic Wagon	225 >227		
Thermometer	100 >103		
Thermoregulator	387		
Tilt Truck	238		
Timer	102, 103		

VWYZ

pag.

Vacuum Machine	158
Vacuum Pump Wine Preserver	290
Vegetable Cutter	81, 83, 84, 88, 89
Vegetable Peeler	81, 84
Visitor Kit	205
Waffle Iron Machine	142
Wall Clock	103
Wall Draining Rack	212
Warming Display	140
Warming Plate	156
Warning Sign	235
Waste Bin	236 >243
Waste Container	236 >243
Water Jug, S/S	247
Whistling Kettle	15
Wind Light	292
Wine Cooler	288, 289
Wine Cooler Stand	288
Wine Taster	290
Wine Thermometer	290
Wire Cutter	86, 430
Wire Dish Rack	212
Wire Grid	44, 428
Wire Whip	60
Wok Pan	12, 22, 128, 129
Wood Mixing Spoon	68
Wood Spatula	68
Wooden Platter	30, 31
Yanagi Sashimi	134
Yule Log Molds With Cover, S/S	80
Zabaione Bowl	24

A					
	pag.				
Abdeckhaube	286, 329, 330, 366	Brotkorb, Stapelbar, Lldpe	170	Eis-Ausstechforme	313
Abfallbehälter	236 >243	Brotkorb-Gestell	174, 175	Eisbehälter	312
Abfalleimer	236 >243	Brottschneidgerät	365	Eis-Crusher	152, 319
Abtropfplatte	44	Brotteller	248	Eisdipper	312
Acetat Bandrolle/Blätter	437	Büffetgestell	352, 353, 354	Eiseimer	319, 320
Airbrush-Pistole	430	Büffet-Leiter	370 >372	Eis-Kugel-Former	319
Alkohol-Meßbecher	320	Buffet_Ständer	355	Eismeissel	383
Ananasausstecher	81	Butterfaß	91	Eisportionierer	312
Apfelschäler	82, 85	Buttermesser	81, 113	Eisstößel	319
Aschenbecher	295	Butter-Rechaud	25	Eiswasserkrug, Edelstahl	247
Atlantic Buffet System	385 >389	Butterservierer	279, 280	Eiszerstosser	319
Aufschnittmaschine	154	Butterstreicher	269	Elektro-Dönergrill	137
Auslegeplatte	356, 437	CD	pag.	Elektro-Heizelement	385, 387
Ausstechformen, Edelstahl Rostfrei 90, 91, 407 >415, 417		Caramelisier-Eisen	157, 429	Elektro-Maschinen	136 > 158
Ausstechformen, Pa+	416	Cerealien-Ständer	364, 369 >371	Entkerner	81, 113
Ausstechmatte	449	Chafing Dish	387, 390, 392	Entsteiner	86
Austernplatte	287	Chariots	398 >402	Essig U. Öl-Stand	249
B	pag.	Chef Hosen	202	Essstäbchen	126, 132
Backbleche, Aluminium	428	Chef Jacke	202	Extractor	451
Backbleche, Silikonbeschichtet	428	Chef-Kochmütze	202, 205	Fahrgestell	211, 222, 229, 230
Backbleche-Regalwagen	227, 228	Chinesische Suppentopf	130	Fahrgestell Für Spülkörbe	211
Backhandschuhe	203, 204	Cocktail Master	324	Falten Eimerwagen	238
Backkerne	437	Cocktail-Sieb	320	Feinkostöffel, San	348
Backschaufel, Fugenlos	66	Cocktails-Laufbrunnen	378	Fingerfood	347, 348
Backschaufel, Pa+	60	Coffee Urn	391, 395	Fischentschupper	81, 113
Backtrennfolie	437	Cognacwärmer	290	Fischheber, Pa+	57, 58
Balti-Pfanne	129	Couscoustopf	17	Fischkochkessel	14, 20, 24
Bar-Behälter	320	Crêpegerät	137	Flair Bottle	323
Bar-Beilagenbehälter	321	Dampf-Kocher	128, 130	Flambier-Rechaud	285
Bar-Kombination Salz-/Zuckerumrander	324	Dash Bottle	322	Flasche Zum Anfeuchten	436
Barman-Koffer	325	Deba	134	Flaschen-/Gläser-Einsatzring	377
Behälter Mit Deckel	217	Deckel, Aluminium	17	Flaschenkühler	288, 289, 361, 364
Behälter, Pe	217	Deckel, Edelstahl Rostfrei	4, 7, 12	Flaschenöffner	109, 115, 327
Behälter, Polypropylen	214	Deckel, Kupfer	24, 26	Flaschenregal	70
Behälter, Pp	212	Dehydratisierapparat	153	Flaschenständer	325
Behälter, Stapelbar, Hdpe	218, 219, 229	Dekorationslöffel	89	Flaschenteller	249
Besteck, Arthur Krupp	261 >265	Dekorationswerkzeuge	80, 81, 84, 87, 88, 89	Flaschen-Zerquetscher	96
Besteckbehälter	210, 281, 282, 363, 364	Digitale Volumenlöffelwaage	103	Fleischgabel, Fugenlos	66
Besucher-Kits	205	Digitalkochalarm	102, 103	Fleischhaken	197
Bierglasbürstenständer	324	Dosenöffner	96, 98, 109, 115	Fleischspiess	126, 196, 340
Biscuit-Spachtel	431	Dosierer, Edelstahl Rostfrei	429	Fleischwolf	154
Blaszuckerspritze	431	Dosierflasche	331	Flexipanbackformen	466 >476
Blumeheber	423	Dosierspender	331	Flexipat	475
Blumenstempel	423	Dosiervorratsbehälter	323	Folienchneider	327
Blumenvase	292	Drahtschaumlöffel	67, 68, 132	Fondue-Service	25, 285
Bodenreinigungswagen	240, 241	Drahtschneider	86, 430	Friteusen	141
Bons-Halter	70	Dreieckschneidewalze	434	Frittier-Korb	22, 44
Boston Shaker	321	Dressiernadel	196	GHI	pag.
Bouillonstoffsieb	78	Dressingtopf	365	Gaskochfeld	140
Brasiere	14, 20	EF	pag.	Gastronorm-Behälter, Edelstahl Rostfrei	41 >43
Bratenplatte	250, 317, 358, 359, 361	Eierbecher	274	Gastronorm-Behälter, Induktion	53
Bräter	19, 13, 20, 24	Eier-Behälter	83	Gastronorm-Behälter, Melamin	51
Brenngel	393	Eierkocher	71	Gastronorm-Behälter, Polykarbonat	45, 46
Brennstoffhalterung	387	Eierkorb	175	Gastronorm-Behälter, Polypropylen	48 >50
Brot-Ausstechforme	169	Eierringe	84	Gastronorm-Behälter, Porzellan	52, 53
Brötchen-/Snackdispenser	328	Eierteiler	83	Gastronorm-Behälter, Tritan	47
Brötchen-Spender	365	Eimer	75, 76, 241	Gastronorm-Korb, Pp	217
Brotformen	170	Eimer Mit Presse	241	Gebäckspritze	426
Brotkorb	171 >178, 247, 281	Einwegbecher	311, 340, 341	Gebäckständer	249, 317
		Einweg-Schutzhüllen	71	Gebäkfüllmaschine	429
				Geleeformen	461

Gemüsehobel Mandoline	85 >87	Krug	125, 247, 272, 273, 371, 372	Pasteten-Formen	80
Gemüseschäler	81, 84	Krümelsammler	286	Pedaleimer	236 >243
Gemüseschneider	81, 83, 84, 88, 89	Kuchenformen Mit Antihafbeschichtung	443 > 448	Permanentausgiesser	326
Gemüsesieher	60	Kuchenformen, Aluminium	441	Peugeot	298 >305
Gießer	247	Kuchenformen, Silikon	452, 459 >476	Pfanne Mit Antihafbeschichtung	4, 12, 18
Gießer-Portionierer	325	Kuchenpalette, Edelstahl Mit Pp-Griff	62, 63	Pfanne, Aluminium	17, 19, 28
Gießlöffel, Fugenlos	65	Kuchenpinsel	81, 113, 435	Pfanne, Edelstahl Rostfrei	4, 7, 12
Gitter Für Biscuit	449, 450	Küchensäge	197	Pfanne, Kupfer	24, 26
Gläser	212, 336 >338	Küchenschnüre	196	Pfanne, Stahl	21, 22
Gläserabstellmatte	321	Küchenutensilien	107 >119	Pfannenstand	22
Gläsersteller	249	Kugelausstecher	81, 113	Pizzablech	165 >167
Glashalter	340	Kuhlakku	222, 221, 362	Pizzanetscheiben	164, 166
Gn-Ofenblech, Emalliert	44	Kühlschale	364, 368	Pizzaschaufel Und Zubehör	160 >166
Gn-Regalwagen	227	Lageruntersätze/Trittbrett	229, 243	Platte, Melamin	121 >124
Gourmet-Gläser	276, 346	Lebensmittelmaschinen	145 >147	Platzmatten	283
Gourmet-Löffel, Edelstahl	354	Leerflaschen-Wagen, Pp	242	Platzteller	249
Grätenentkerner	69	Lichtsäule	287	Pommes-Frites-Schaufel	68
Grillplatte	137	Likör- U. Fondanttrichter	429	Portioniererausgiesser	326
Grill-Teller	71	Limonadenlöffel	270	Porzellan, Arthur Krupp	252 >259
Grillzange	69	Lineal	431	Poster 'La Cuisine'	89
Haarkappe, Tnt	205	Löffel, Melamin	123, 348	Pralinen Gabelchen	431
Hamburgerpresse	198	Löffel, Pa+	57 >59	Praliné-Schneideapparat	432
Handwaschbecken	195	Löffel, Pc	61	Presse Canard	78
Haube/Speiseglocke	72, 249, 286, 329, 330, 366	Lufterfrischer Duet	232	Pulse, Reinigungssystem	234
Holzbrett	30, 31			Punchbowle	377, 387
Holzlöffel	68	MNO	pag.	Pyramide, Edelstahl	354
Holzschäber	68	Magnet-Messerhalter	194	Quick Cart	232
Hummerzange	287	Marzipan-Kneifer	417	Raclette-Service	286
Induktionskochfelder	155, 156, 386	Marzipan-Messer	431	Raffel	85, 93, 94, 115, 132
Infrarot-Wärmestrahler	396	Mayonnaisefaß	91	Ramekin	30, 39, 280
Insektenvernichter	158	Mehlschaufel	61, 73	Ravioli-Formen	94
Iso-Dispenser, Edelstahl Rostfrei	375	Menage	283	Receptionsschell	294
		Messbecher	72, 73	Rechaud	140
KL	pag.	Messer Und Zubehör	180 >195	Rechnungstablett	249
Kaffeeautomat	395	Messeraufhänger	194	Reiskocher	157
Kaffeebereiter	272	Metzgereiartikel und Zubehör	195 >200	Reislöffel	128
Kaffeekanne	247, 272	Mikrofasertuch	235	Reistasse	123
Kaffeelöffelbehälter	248	Milchgießer	247, 248	Röhrchenbehälter	248
Kakaostreuer	316	Milchkanne	373, 374	Rolltophaube	329, 361, 366
Kakaostreuer-Masken	316	Miniaturen	25, 28, 30	Rollwalze	433 >435
Kamme	448	Mixer	143 >152	Rost	44, 428
Kartoffelschneidgerät	84	Monoporzion-Blech	451	Roul'Pat	438
Käsedose	283	Mop	234, 235, 241	Rührbesen	60
Käsestreuer	283	Mörser Und Stößel	131	Runner	283
Kasten Und Körbe, Pp	216, 217	Mühle, Für Pfeffer U. Salz	298 >305		
Kaviar-Bestecke, Perlmuttern	288	Müllschaufel	234, 242	S	pag.
Kaviarkühler	288	Muscheltopf	286	Saftdispenser	364, 374, 375
Kerzenleuchter	291	Müslispender	373, 374	Saft-Spritze	69
Kindersitz	238	Nahrungsmittel-Behälter	215, 216	Sahnebereiter	313, 314
Kinderstuhl	239	Nudelkochsieb	3, 9, 15, 17	Sahnekännchen	316
Klappbares Gestell	232	Nussknacker	286	Salamander	139
Knoblauchpresse	86	Obstkorb	318	Salatschleuder	77
Kocher	15	Obstständer	375	Salatschüssel	280, 281, 349, 350
Kochgeschirr, Aluminium	16 >20	Ofen Und Mikrowellen	138, 139, 155	Salz- Und Pfefferstreuer	282, 283
Kochgeschirr, Edelstahl Rostfrei	2 >15	Ofen-Roste, Emalliert	44	Salzgebäckständer	342, 343, 348
Kochgeschirr, Gusseisen	29 >37	Ofenschalen, Porzellan	39	Salzinhalt-Messer	103
Kochgeschirr, Kupfer	23 >26	Ölkanne	131, 160	Salzstangenkorb	281
Kontaktgrill	136	Oroshi	134	Samovar	394
Kontrollsystem Fu_R Bratenöle	103			Sangrialöffel	61
Korkenzieher	327, 328	PQR	pag.	Saucière Mit Fuss	280
Kotelettklopfer	197	Pallet	217	Schaumlöffel, Fugenlos	66
Krake-Presse	79	Party-Tablett	340	Schaumlöffel, Pa+	58, 59

Schaumseifenspender	232	Ständer Für Konfiturgläser	249	Tortenteiler	434
Schere	85, 163, 267	Ständer Für Weinkühler	288	Tranchierbrett	124, 199, 200, 277, 361
Schiefer, Natur	274, 275	Staubsauger, Mechanisch	234	Trichter	72
Schinkenhalter	198	Stencil	451	Trüffelschneider	281
Schneckenplatte	288	Stielschäber, Pa+	57	Tüllen	418 >425
Schneebeesen	60	Stielsieb	60, 74, 75, 77, 78	Tüllenansatzstück	422
Schneidewalzen	94	Suppenlöffel	124	Tüllen-Bürste	423
Schnellkochtopf	10	Suppensieb	60	Türsymbol	293
Schokoladenformen	452 >460	Suppenterrine	123, 280	UVWYZ	pag.
Schokowärmer	140	Suppenwärmer	396	Überschuhe	205
Schöpflöffel, Fugenlos	65	Sushi-Ausstechform	127	Überziehgitter	427
Schöpflöffel, Pa+	58, 59	Sushi-Bridge	125	Universalbox, Stapelbar	329
Schurz	201, 202, 205	Sushi-Matte	127	Usuba	134
Schüssel	74, 76, 77	T	pag.	Vakuumiergerät	158
Schüssel, Edelstahl Rostfrei	361	Tablett Gn 1/1	347	Vitrine Für Verkaufstheke	328, 329
Schüssel, Glas	361	Tablett, Edelstahl	358, 359	Vitrine, Kühlbar	329, 361, 367, 368
Schüssel, Melamin121	>123, 279, 347, 348, 351, 352, 361	Tablett, Melamin	121, 122, 123, 178, 346	Vorratsbehälter	323
Schüssel, Pc	213	Tablett, Umweltfreundlich	335	Vorratsbehälterwagen	216
Schüssel-Box	362, 363	Tablett-Träger	334	Vorspeisen-Schaufenster	127
Schüssel-Modul	361	Tablettwagen	230	Vorspeiseteller	342, 343
Sekt Wasserfall	378	Tako Sashimi	134	Waage	104, 105
Sekt-/Weinflaschenstopfen	326, 327	Tasse, Pc	213	Waffeleisen-Gerät	142
Senfschale	279	Tawa-Eisenpfanne	130	Wagen Für Versorgung Der Kühlschränken	230
Servier-/Transportwagen	228, 229	Teebox	394	Wand-Trockengestell	212
Servier-Besteck, Serie Living	267 >270	Teekanne	247	Wanduhr	103
Servier-Brett, Melamin	276, 277, 278, 279	Teesieb	273	Warme Theke	140
Servier-Brett, Polyester	276, 277, 278	Teigausroller	94	Wärmepistole	383
Serviergestell, Metall Hartverchromt	345, 365	Teig-Glätter	431	Wärmeplatten	156
Servierlöffel, Melamin	123	Teig-Rad	107, 114, 433	Wärmewagen	225 >227
Servierplatte, Drehbar	275	Teigschaber	436	Warnschilder	235
Serviertablett	333 >335	Teigschäber, Pa+	57	Wasserbadkasserolle	14, 20, 25, 158
Serviertablett, Edelstahl Rostfrei250, 317, 358, 359, 361		Teller, Pc	213	Weinkühler	288, 289
Servierzangen	267 >270	Tellergestell	212	Weinprobenschale	290
Serviettenhalter	248, 317	Teller-Transportwagen	212, 225, 226	Wein-Thermometer	290
Serviettenring	283	Tellerwagen, Einstellbar	212	Wein-Vakuum-Pumpe	290
Shaker	322	Tellerwärmer	285	Windeln-Tisch	238
Shakerglas	321, 322	Temperierlöffel, Pa+	57	Windlicht	292
Sieb	73, 74, 436	Temperiermaschine	429	Winkelpalette, Pa+	57
Silform	477	Tempura-Rost	129	Wischmop	234, 242
Silikonbackfolie	437, 438	Terrine-Schale	279	Wok-Pfanne	12, 22, 128, 129
Silikon-Stielhülle	22, 32	Thai-Messer	84	Wüstchenwärmer	137
Silpain	438	Thermischetasche	164	Yanagi Sashimi	134
Silpat	438	Thermobehälter	165, 220 >225	Yogurt-Ständer, Kühlbar	368
Sirup-Hydrometer	430	Thermokanne	247, 272, 375	Zabaione-kasserolle	24
Slim-Jim-Transportwagen	237	Thermometer	100 >103	Zahnstocher	340
Soda Siphon	316	Thermoregler	387	Zange, Pa+	58
Sojasaucékännchen	124	Thermo-Tablett	212	Zange, Pc	61
Spargeltopf	9	Tischeimer	286	Zauberlöffel	320
Sparschäler	81, 84, 113	Tischtuch Klammer	283	Zeitungshalter	89
Speisekartenhalter	292	Toaster	139	Zigarrenschneider	294
Speisenbehälter	224	Toastständer	274	Zigarren-Vitrine	294
Speisen-Kaste	226	Toban-Pfanne	125	Zimmer-Servicewagen	232, 233, 240
Spiegel, Acryl	357	Tomatenpassiergerät	96, 97	Zitronenpresse	318
Spitzsieb	78	Tomatenschneidergerät	80	Zitruspresse	149, 152, 318
Spritzbeutel	425 >426	Tontopf	131	Zuckerdose	247
Spritzbeutel-/ U. Tüllenaufhänger	427	Tortenplatte	329, 356, 437	Zuckerlampe	430
Spritzbeutel-Absetzständer	425	Tortenplatte Mit Drehfuss	427	Zuckerpfännchen	24
Sprühpistole, Elektrisch	429	Tortenring, Edelstahl Rostfrei	438 >440	Zuckerstreuer	316, 436
Spülmaschinenkörbe	209, 210	Tortenschaufel	427	Zuckerthermometer-Träger	431
Stabmixer	143, 144	Tortenspitzen	427	Zuckertütenschale	248, 317
Standascher	238, 243	Tortenständer	329, 330, 376, 377, 379		

AB	pag.				
Adaptateur À Douilles	422	Carafe	125, 247, 272, 273, 371, 372	Coupe-Légumes	81, 83, 84, 88, 89
Aérographe	430	Carafe À Eau, Inox	247	Coupe-Pain	365
Aiguille À Brider	196	Carameliseur	157, 429	Coupe-Tomates	80
Anneau Porte Verres Et Bouteilles, Inox	377	Carré En Microfibre	235	Coupe-Truffes	281
Aplatisseur	197	Cartouche Eutectique	222, 221, 362	Couscoussier	17
Appareil À Couper Les Pralinés	432	Cascade À Champagne	378	Couteau À Beurre	81, 113
Ardoise, Naturelle	274, 275	Casiers À Vaisselle	209, 210	Couteau À Pâte D'Amande	431
Assiette, Pc	213	Casse-Glace	319	Couteau Stylet Thai	84
Atlantic Buffet System	385 >389	Casse-Noix	286	Couteaux Et Accessoires	180 >195
Autocuiseur	10	Casserole Coquillage	286	Couvercle Roll-Top	329, 361, 366
Bac À Couverts	210, 281, 282, 363, 364	Cendrier De Table	295	Couvercle, Aluminium	17
Bac Gn Émaillé	44	Cendrier Sur Pied	238, 243	Couvercle, Cuivre	24, 26
Bacs Gastronormes, Induction	53	Cercle À Tarte, Inox	438 >440	Couvercle, Inox	4, 7, 12
Bacs Gastronormes, Inox	41 >43	Chafing Dish	387, 390, 392	Couverts À Caviar, Nacre	288
Bacs Gastronormes, Melamina	51	Chaise D'Enfant	239	Couverts, Arthur Krupp	261 >265
Bacs Gastronormes, Polycarbonate	45, 46	Chalumeau De Cuisine	383	Crémier	247
Bacs Gastronormes, Polypropylène	48 >50	Chapeau De Chef	202, 205	Crêpière	137
Bacs Gastronormes, Porcelaine	52, 53	Chariot	211, 222, 229, 230	Crochet À Viande	197
Bacs Gastronormes, Tritan	47	Chariot À Glissières Gn	227	Cuiller À Riz	128
Baguettes Chinoises	126, 132	Chariot À Glissières Pour Plaques	227, 228	Cuiller À Soupe	124
Bain-Marie	14, 20, 25, 158	Chariot À Plateaux	230	Cuiller Gourmet, Inox	354
Balai	234, 242	Chariot À Verre, Pp	242	Cuiller, Melamine	123, 348
Balance	104, 105	Chariot Casiers À Vaisselle	211	Cuillère À Balance Volumétrique Numérique	103
Banneton	170	Chariot De Service	228, 229	Cuillère À Glace	312
Baratte À Beurre/Mayonnaise	91	Chariot Lavage Du Sol	240, 241	Cuillère À Servir, Melamine	123
Bassine	74, 76, 77	Chariot Mobile De Stockage	216	Cuillère À Soda	270
Batteries De Cuisine, Aluminium	16 >20	Chariot Modulable Pour Assiettes	212	Cuillère En Bois	68
Batteries De Cuisine, Cuivre	23 >26	Chariot Porte-Assiettes	212, 225, 226	Cuillère Magique	320
Batteries De Cuisine, Fonte	29 >37	Chariot Pour Frigo-Bar	230	Cuillère Monobloc	65
Batteries De Cuisine, Inox	2 >15	Chariot Pour Slim Jim	237	Cuillère, Pc	61
Benne	238	Chariot Room-Service	232, 233, 240	Cuillères Plume	89
Boîte À Bol	362, 363	Chariot Thermique	225 >227	Cuillères, San	348
Boîte À Condiments	321	Charlotte, Tnt	205	Cuiseur À Oeuf	71
Boîte À Sachets De Thé	394	Châssis Repliable	232	Cuiseur À Vapeur	128, 130
Boîte, Empilable	329	Chauffe Plats	140	Cuit Riz	157
Bol À Riz	123	Chauffe-Chocolat	140	Cuit-Asperges	9
Bol Réfrigérée	364, 368	Chauffe-Saucisses	137	Cure-Dents	340
Bol, Inox	361	Ciseau À Glace	383	Cylindres De Coupe	94
Bol, Melamine	121 >123, 279, 347 >348, 351 >352, 361	Ciseaux	85, 163, 267		
Bol, Pc	213	Clip Porte-Verre	340	DEF	pag.
Bol, Verre	361	Cloche	72, 249, 286, 329, 330, 366	Dash Bottle	322
Bordeur À Verres	324	Clous À Fleurs	423	Deba	134
Boston Cône	321	Cocktail Master	324	Décapsuleur	109, 115, 327
Boucherie, Accessoires	195 >200	Coffee Urn	391, 395	Découpoir À Pain	169
Bouchon À Champagne/Vin	326, 327	Collecteur	236 >243	Découpoirs, Inox	90, 91, 407 >415, 417
Bouchon Doseur/Verseur	325, 326	Compresseur	430	Découpoirs, Pa+	416
Bougeoir	291	Conteneur À Double Paroi, Inox	365	Dénoyauteur	86
Bouilloire À Sifflet	15	Conteneur À Sucre	248, 317	Dentelles	427
Bouteille À Puncher	436	Conteneur Empilable, Hdpe	218, 219, 229	Déshydrateur Fruits Et Légumes	153
Braisière	14, 20	Conteneur Isotherme	165, 220 >225	Désinsectiseur Électrique	158
Brochettes	126, 196, 340	Conteneur Multiservice, Pp	212	Distributeur À Céréales	373, 374
Brosse À Douilles	423	Conteneur Pour Aliments	215, 216	Distributeur À Jus	364, 374, 375
Brosse À Laver Les Verres	324	Conteneur, Pe	217	Distributeur À Lait	373, 374
Broyer À Glace	152, 319	Coquetier	274	Distributeur À Pain	365
		Corbeille À Pain	171 >178, 247, 281	Distributeur De Savon Mousse	232
C	pag.	Corbeille À Pain, Empilable, Lldpe	170	Distributeur Isothermique, Inox	375
Cafetière	247, 272	Corps De Chauffe Electrique	385, 387	Diviseur À Tarte	434
Cafetière Électrique	395	Coupe À Beurre	279, 280	Doseur	331
Caisson Thermique	226	Coupe-Capsule	327	Doseur À Crème	429
Canne À Journaux	89	Coupe-Cigares	294	Doseur Pour Miel/Lait	316
		Coupe-Croissants	434	Doseur Pour Sauce De Soja	124
		Coupe-Frites	84	Douilles	418 >425

Ebauchoirs	431	Lyre	86, 430	Pelle À Frites	68
Ecailleur À Poisson	81, 113	MNO	pag.	Pelle À Friture, Pa+	57, 58
Écumoire À Friture	67, 68, 132	Machine Pour L'Emballage Sous-Vide	158	Pelle À Poussière	234, 242
Écumoire Monobloc	66	Machine Pour Laminer/Couper Pâtes	94	Pelle À Tarte	427
Écumoire, Pa+	57 >59	Machines Électriques	136 >158	Pèse-Sirop	430
Egouttoir Au Mur	212	Mallette De Barman	325	Peugeot	298 >305
Enlève Fleurs	423	Mandoline	85 >87	Pic À Glace	319
Entonnoir	72	Marmite À Soupe	396	Pictogrammes	293
Entonnoir À Crème	429	Marmite Chinoise	130	Pince À Arêtes	69
Entonnoir À Fondant	429	Masques À Cacao	316	Pince À Gaufrer	417
Eplucheur	81, 84, 113	Ménagère	283	Pince À Grille	69
Escalier Buffet	370 >372	Mesureur De Cocktail	320	Pince À Homard	287
Essoreuse À Salade	77	Miniatures	25, 28, 30	Pince À Jambon	198
Etagère À Buffet	352, 353, 354	Minuterie Digitale	102, 103	Pince, Pa+	58
Etagère À Fruits	375	Miroir Acrylique	357	Pince, Pc	61
Etamine Passe-Bouillon	78	Mixeurs	143 >152	Pinceau	81, 113, 435
Extractor	451	Module Pour Ravieres	361	Pinces À Nappe	283
Feuille De Cuisson	437	Mortier Et Pilon	131	Pinces À Servir	267 >270
Fingerfood	347, 348	Moule À Glace	313	Pistolet Electrique	429
Flacon Doseur	331	Moule À Pomme	81, 113	Planche À Découper	124, 199, 200, 277, 361
Flair Bottle	323	Moule À Ravioli	94	Planche En Bois	30, 31
Flexipan	466 >476	Moule À Steak	198	Planche Service, Melamine	276 >279
Flexipat	475	Moule À Sushi	127	Planche Service, Polyester	276 >278
Fondeuse À Fromage	286	Moule À Sushi	127	Plaque À Cuisson, Aluminium	428
Fontaine À Cocktails	378	Moule Boules De Glace	319	Plaque À Gâteau Monoportion	451
Fouet	60	Moules À Chocolat	452 >460	Plaque À Pâte Brisée	449
Fourchette Monobloc	66	Moules À Gelées	461	Plaque À Pizza	165 >167
Fours Et Micro-Ondes	138, 139, 155	Moules Flexipan	466 >476	Plaque À Rôtir	19, 13, 20, 24
Frange	234, 235, 241	Moules, Aluminium	441	Plaque À Snacker	137
Friteuses	141	Moules, Revêtement Anti-Adhésif	443 >448	Plaque Chauffante	156
Fromagère	283	Moules, Silicone	452, 459 >476	Plaque, Revêtement Silicone	428
GHIKL	pag.	Moulin À Tomates	96, 97	Plaques Induction	155, 156, 386
Gants/Moufles	203, 204	Moulines Poivre/Sel	298 >305	Plat À Escargots	288
Gaufrier	142	Moutardier	279	Plat À Four, Porcelaine	39
Gel Combustible	393	Mouvette, Pa+	57 >59	Plat À Grillage	71
Glacière À Cacao	316	Noyaux De Cuisson	437	Plat À Huîtres	287
Gouttières	80	Oroschi	134	Plat À Rôti, Inox	250, 317, 358, 359, 361
Grembuile	201, 202, 205	Outils À Pâte D'Amandes	431	Plat De Présentation	249
Gril À Kebab/Gyros	137	Ouvre Boîtes	96, 98, 109, 115	Plat Gâteau	329, 356, 437
Grill À Contact	136	PQ	pag.	Plat, Melamine	121 >124
Grille	44, 428	Palette	217	Plateau Double Fond Perforé	44
Grille À Four Émaillé	44	Palette Inox Avec Mache En Pp	62, 63	Plateau Gn 1/1	347
Grille À Glacer	427	Palettes/Marche-Pied Mobile	229, 243	Plateau Hors D'Oeuvres	342, 343
Grille À Tempura	129	Panier À Frirer	22, 44	Plateau Isotherme	212
Grille Pour Biscuit	449, 450	Panier À Fruits	318	Plateau Party	340
Gueridon Pâtissier	329, 330, 376, 377, 379	Panier À Gressins	281	Plateau Porte-Monnaie	249
Guéridon Plaque Tournante	427	Panier À Oeufs	175	Plateau Vitrine	356, 437
Hachoir	154	Panier En Polypropylène	214	Plateau, Éco	335
Horloge À Paroi	103	Panier Gastronomique, Pp	217	Plateau, Inox	250, 317, 358, 359, 361
Housses Usage Unique	71	Panneau D'Avertissement	235	Plateau, Melamine	121, 122, 123, 178, 346
Huilière	131, 160	Pantalon Du Chef	202	Plateaux	333 >335
Jetables	311, 340, 341	Passe-Bouillon	60	Poêle Balti	129
Kit Visiteur	205	Passoire	60, 74, 75, 77, 78	Poêle Chinoise	12, 22, 128, 129
Lampe À Bougie	292	Passoire À Cocktail	320	Poêle Tawa	130
Lampe À Sucre	430	Passoire À Thé	273	Poêle Toban	125
Lampe Chauffante Infra-Rouge	396	Passoire Chinois	78	Poêle, Acier	21, 22
Lave-Mains Autonome	195	Passoire Cuit-Pâtes	3, 9, 15, 17	Poêle, Acier Inox	4, 7, 12
Lisse-Pâte	431	Peigne	448	Poêle, Aluminium	17, 19, 28
Louche À Sangria	61	Pèle-Pommes	82, 85	Poêle, Cuivre	24, 26
Louche Monobloc	65	Pelle À Enfournier Et Accessoires	160 >166	Poêle, Revêtement Anti-Adhésif	4, 12, 18
Louche, Pa+	58, 59	Pelle À Farine	61, 73	Poelon À Sucre	24
				Poelon À Zabaione	24

TABLE DES MATIERES FRANCAIS

Poire À Sucre Soufflé	431	Récipient Avec Couvercle	217	Sushi Bridge	125
Poissonnière	14, 20, 24	Récipient Mesure	72, 73		
Pompe À Jus	69	Récipient Réserve	323	TUVY	pag.
Pompe Vacuum À Vin	290	Récipient Verseau	323		
Porcelaine, Arthur Krupp	252 >259	Récipients Et Containers, Pp	216, 217	Table À Langer	238
Porte Brûleur	387	Règle	431	Tako Sashimi	134
Porte Chalumeaux	248	Revêtement Manche En Silicone	22, 32	Tamis	73, 74, 436
Porte Confitures	249	Robots Multifonction	145 >147	Tapis À Sushi	127
Porte Cuillères	248	Ronds À Oeufs	84	Tapis À Verres	321
Porte Huile Et Vinaigre	249	Rouleau	433 >435	Tapis Cuisson, Silicone	437, 438
Porte Plateaux	334	Rouleau/Feuilles Acétate	437	Tarnineur	269
Porte Serviettes	248, 317	Roulette À Pâte	107, 114, 433	Tasse, Pc	213
Porte-Appetizers	342, 343, 348	Roul'Pat	438	Tastevin	290
Porte-Assiettes	212	Runner	283	Tempereuse	429
Porte-Couteaux Magnetic	194	S	pag.	Termoregulador	387
Porte-Fiches	70			Terrine À Foie Gras	279
Porte-Manger	224	Sac À Dresser	425 >426	Test Des Huiles	103
Porte-Menu	292	Sac Thermique	164	Testeur De Salinité	103
Porte-Objets À Bar	320	Saladier	280, 281, 349, 350	Théière	247
Porte-Oeufs	83	Salamandre	139	Thermomètre	100 >103
Porteserviette	283	Salière Et Poivrier	282, 283	Thermomètre À Vin	290
Poster 'La Cuisine'	89	Samovar	394	Tire-Bouchon	327, 328
Pot À Lait	247, 248	Sangles	196	Toaster	139
Pot D'Argile	131	Saucière Sur Pied	280	Toiles À Pizza	164, 166
Pot Isotherme	247, 272, 375	Saupoudreuse	316, 436	Tranche-Oeufs	83
Poubelle À Pédale	236 >243	Scie À Os	197	Trancheur Électrique	154
Poubelle De Table	286	Seau	75, 76, 241	Ustensiles À Servire, Serie Living	267 >270
Poudreuse À Fromage	283	Seau À Glace	319, 320	Ustensiles De Cuisine	107 >119
Présentoir À Céréales	364, 369 >371	Seau À Vin	288, 289	Ustensiles Décoration	80, 81, 84, 87 >89
Présentoir À Paniers	174, 175	Seau Avec Essoreur	241	Usuba	134
Présentoir À Sandwich	328	Séchoir À Poche/Douilles	427	Vase À Fleurs	292
Présentoir Chaud	140	Seringue À Pâtisserie	426	Verre À Shaker	321, 322
Présentoir Poêles	22	Service À Fondue	25, 285	Verres	212, 336 >338
Présentoir Tournant	275	Servierwagen	398 >402	Verres Gourmet	276, 346
Présentoir, Chromé	345, 365	Serviteur Muet	249, 317	Veste De Chef	202
Presse Agrumes	149, 152, 318	Set De Table	283	Vide Ananas	81
Presse Ail	86	Shaker	322	Vide-Pommes	81, 113
Presse Bouteilles	96	Siège Enfant	328	Vitrine À Cigares	294
Presse Canard	78	Silform	477	Vitrine À Comptoir	328, 329
Presse Citron	318	Silpain	438	Vitrine Réfrigérée	329, 361, 367, 368
Presse Poulpe	79	Silpat	438	Vitrine Tapas	127
Pulse, Système De Nettoyage	234	Siphon À Crème	313, 314	Yanagi Sashimi	134
Pyramide, Inox	354	Siphon À Eau De Seltz	316		
Quick Cart	232	Socle Lumineux	287		
R	pag.	Sonette De Réception	294		
		Soupière	123, 280		
Rack À Bouteilles	70	Sous Bouteille	249		
Raclettes	436	Sous-Verre	249		
Rafraîchisseur	377, 387	Spatule À Biscuit	431		
Rafraîchisseur À Bouteilles	288, 289, 361, 364	Spatule En Bois	68		
Rafraîchisseur À Caviar	288	Spatule Monobloc	66		
Rafraîchisseur Duet	232	Spatule, Pa+	57 > 60		
Rafraîchissoir À Yogurt	368	Stencil	451		
Ramasse Miettes	286	Sucrier	247		
Ramequin	30, 39, 280	Support À Bouteilles	325		
Râpe	85, 93, 94, 115, 132	Support À Couteaux	194		
Réchaud	285	Support Buffet	355		
Réchaud À Beurre	25	Support Pour Toast	274		
Réchaud À Cognac	290	Support Sacs À Poches	425		
Réchaud À Flambar	285	Support Seau À Champagne	288		
Réchaud À Gaz	140	Support Thermomètre À Sucre	431		
Récipient À Glace	312	Sur-Chaussures	205		

AB	pag.				
Ablandador De Carne	197	Caja Para Bolsitas De Tè	394	Colector Abertura Pedal	236 >243
Abrebotellas	109, 115, 327	Cajón Isotérmico	226	Colector Sobremesa	286
Abrelatas	96, 98, 109, 115	Caldera Para Huevo	71	Columna Luminosa	287
Adaptador Para Boquillas	422	Caldero	74, 76, 77	Combustible Gel	393
Aerógrafo	430	Calentador Brandy	290	Compactador Para Botellas	96
Aerómetro	430	Calentador De Platos	140	Compresor	430
Aguja De Cocina	196	Calentador De Salchichas	137	Conjunto Visitador	205
Alcuza	131, 160	Calentador Electrico	385, 387	Consumibles	311, 340, 341
Alfombra Barman	325	Calentador Para Flambear	285	Contenedor Apilable, Hdpe	218, 219, 229
Anillo Para Botellas Y Vasos, Inox	377	Calentador Para Salzas	140	Contenedor Comida	224
Anillo Para Tartas, Inox	438 >440	Campana	286, 329, 330, 366	Contenedor Con Cenicero	238, 243
Anillos Para Huevos	84	Candelabro	291	Contenedor Con Tapa	217
Asador De Kebab/Gyros	137	Caños Dosificador	326	Contenedor De Combustible Sólido	387
Asiento De Seguridad Para Niños	238	Carnicero, Accesorios	195 >200	Contenedor En Polipropilene	214
Aspiradora Mecánica	234	Carre Plegable	232	Contenedor Isotérmico	165, 220 >225
Asta Porta Ticket	70	Carretil Para Slim Jim	237	Contenedor Para Alimentos	215, 216
Atlantic Buffet System	385 >389	Carretilla	211, 222, 229, 230	Contenedor Para Huevos	83
Azucarero	247	Carrito Plegable	238	Contenedor Sobres Azúcar	248, 317
Balanza	104, 105	Carro Ajustable Para Platos	212	Contenedor, Doble Pared, Inox	365
Bandeja Cuentas	249	Carro Colector De Botellas, Pp	242	Contenedor, Pe	217
Bandeja Gn 1/1	347	Carro Con Guías Porta Placas	227, 228	Contenedor, Pp	212
Bandeja Isotérmica	212	Carro Contenedores Alimentos	216	Controlador De Aceite De Frituras	103
Bandeja Party	340	Carro De Habitaciones	232, 233, 240	Copa Arroz	123
Bandeja Pasteles	329, 356, 437	Carro De Limpieza	240, 241	Copa Caviar	288
Bandeja, Acero Inox	250, 317, 358, 359, 361	Carro Frigobar	230	Copa Mantequilla	279, 280
Bandeja, Ecológica	335	Carro Para Bandejas	230	Copa Paté	279
Bandeja, Melamina	121, 122, 123, 178, 346	Carro Para Cestas	211	Cordonos	196
Bandejas	333 >335	Carro Porta Platos	212, 225, 226	Cortacápsulas	327
Baño María	14, 20, 25, 158	Carro Servicio	228, 229	Cortador Croissants	434
Barra Magnética Portas Cuchillos	194	Carro Térmico	225 >227	Cortador De Pasta	94
Baterías De Cocina, Aluminio	16 >20	Carros	398 >402	Cortador De Pasteles	434
Baterías De Cocina, Cobre	23 >26	Carros Con Guías Gn	227	Cortador De Patatas Fritas	84
Baterías De Cocina, Hierro Fundido	29 >37	Cascada Champaña	378	Cortador De Verduras	81, 83, 84, 88, 89
Baterías De Cocina, Inox	2 >15	Cascañueces	286	Cortador Pan	365
Batidor	60	Catador Del Vino	290	Cortador Para Pan	169
Batidoras	143 >152	Cenicero De Tabla	295	Cortador Tomates	80
Blondas	427	Cepillo Para Boquillas	423	Cortador Trufas	281
Bol Ensalada	280, 281, 349, 350	Cepillo Triple	324	Cortadora Eléctrica De Fiambres	154
Bol Refrigerda	364, 368	Cernidor	73, 74, 436	Cortadores, Inox	90, 91, 407 >415, 417
Bol, Inox	361	Cesta Escurrefrito	22, 44	Cortahuevos	83
Bol, Melamina	121 >123, 279, 347 >348, 351 >352, 361	Cesta Frutas	318	Cortapastas, Pa+	416
Bol, Pc	213	Cesta Gastronorm, Pp	217	Crepera	137
Bol, Vidrio	361	Cesta Pan	171 >178, 247, 281	Cuberteria Caviar, Nácar	288
Bolsa Térmica	164	Cesta Pan, Apilable, Lldpe	170	Cubeta Gn Esmaltada	44
Bomba Para Jugo	69	Cesta Para Huevos	175	Cubeta Helado	312
Bomba Vacío Vino	290	Cestas Para Vajilla	209, 210	Cubetas Gastronorm, Inducción	53
Boquillas	418 >425	Chafing Dish	387, 390, 392	Cubetas Gastronorm, Inox	41 >43
Botella Para Bañar	436	Chaqueta Chef	202	Cubetas Gastronorm, Melamina	51
Box Para Bol	362, 363	Cinsel Para Hielo	383	Cubetas Gastronorm, Policarbonato	45, 46
Brazos Trituradores	143, 144	Clavos Para Flores	423	Cubetas Gastronorm, Polipropilene	48 >50
		Clip Vidrio	340	Cubetas Gastronorm, Porcelana	52, 53
		Cocktail Master	324	Cubetas Gastronorm, Tritan	47
		Coctelera	322	Cubiertos, Arthur Krupp	261 >265
		Coctelera Boston	321	Cubo	75, 76, 241
		Coffee Urn	391, 395	Cubo Con Prensa	241
		Colador	60, 74, 75, 77, 78	Cubo Hielo	319, 320
		Colador A Red	60	Cubo Térmico Para Botellas	288, 289, 361, 364
		Colador Chino	78	Cubo Vino	288, 289
		Colador Cóctel	320	Cubos Y Contenedores, Pp	216, 217
		Colador De Tè	273	Cubre Mango/Asa Silicona	22, 32
		Colapasta	3, 9, 15, 17	Cubre carritos Desechables	71
		Colector	236 >243	Cubreplatos/Cubierta	72, 249, 286, 329, 330, 366

C	pag.
Cacerola Para Azúcar	24
Cacerola Para Mejillones	286
Cacerola Sabayón	24
Cacillo Monobloc	65
Cacillo, Pa+	58, 59
Cafetera	247, 272
Cafetera Eléctrica	395
Caja Condimentos	321

Cubrezapatos	205	Expositor De Cereales	364, 369 >371	Moldes Para Gelatinas	461
Cuchara Arroz	128	Exprimidor Cítricos	149, 152, 318	Moldes, Aluminio	441
Cuchara De Madera	68	Exterminador De Insectos	158	Moldes, Antiadherentes	443 >448
Cuchara Escala Volumétrica Digital	103	Extractor	451	Moldes, Silicona	452, 459 >476
Cuchara Gourmet, Inox	354	FGH	pag.	Molinillos, Pimienta/Sal	298 >305
Cuchara Mágica	320			Molino Para Tomates	96, 97
Cuchara Para Helados	312	Fingerfood	347, 348	Mortero Y Pistilo	131
Cuchara Para Servir, Melamina	123	Flair Bottle	323	Mostacero	279
Cuchara Refresco	270	Flexipan	466 >476	Núcleos De Cocción	437
Cuchara Sopa	124	Flexipat	475	OP	pag.
Cuchara, Melamine	123, 348	Florero	292		
Cuchara, Pa+	57 >59	Frasco Dosificador	331	Olla Arroz	157
Cuchara, Pc	61	Fregadora	234, 235, 241	Olla Chino	130
Cucharas Para Decoración	89	Freidoras	141	Olla De Barro	131
Cucharas, San	348	Frutero	375	Olla De Presión	10
Cucharón Monobloc	65	Fuente Cocktail	378	Olla Espárragos	9
Cucharón Para Sangría	61	Fuente De Mariscos	287	Ollas Para Sopa	396
Cuchillo Quito Escamas	81, 113	Fuente Horno, Porcelana	39	Oroshi	134
Cuchillo Tailandés	84	Fuente Soufflé	30, 39, 280	Pala Chips	68
Cuchillos Y Accesorios	180 >195	Fundidora De Queso	286	Pala Para Harina	61, 73
Cuscusera	17	Gancho Carnicero	197	Pala Para Tartas	427
DE	pag.	Gorro De Papel Pastel-Cocinero	202, 205	Pala Pizza Y Accesorios	160 >166
		Grill De Contacto	136	Palas Inox Con Mango Pp	62, 63
Dash Bottle	322	Guantes De Protección	203, 204	Palillos	126, 132, 340
Deba	134	Guillotina Para Puros	294	Palita	269
Descorazonador	81, 113	Hervidor Pescado	14, 20, 24	Palos Para Asar	126, 196, 340
Deshidratador De Frutas Y Verduras	153	Hornillo Con Cacerola	25	Paño De Microfibra	235
Difusor De Fragancia	232	Hornos Y Micro-Ondas	138, 139, 155	Paño Para Pasar Sopa	78
Dispensador	331	JLMN	pag.	Pantalones Chef	202
Dispensador Azúcar	316, 436			Papel De Horno	437
Dispensador Bar	320	Jarra	125, 247, 272, 273, 371, 372	Pava	15
Dispensador Cubiertos	210, 281, 282, 363, 364	Jarra Agua, Inox	247	Pedestal Giratorio Para Tartas	427
Dispensador De Cereales	373, 374	Jarra Graduada	72, 73	Pedestal Para Tartas	329, 330, 376, 377, 379
Dispensador De Jabón En Espuma	232	Jarra Leche	247, 248	Peine	448
Dispensador De Leche	373, 374	Jarra Térmica	247, 272, 375	Pelador	81, 84, 113
Dispensador De Pan	365	Jarrita	247	Pelador De Manzanas	82, 85
Dispensador De Zumo	364, 374, 375	Jeringuilla Pastelería	426	Pelador De Verduras	81, 84
Dispensador Salsa De Soja	124	Lampara A Rayos Infrarojos	396	Pera Para Azúcar Soplado	431
Dispensador Térmico	375	Lámpara Para Azúcar	430	Peugeot	298 >305
Dosificador De Porciones	429	Lavamanos Portátil Autónomo	195	Pick Hielo	319
Dosificador Para Cacao	316	Lira	86, 430	Pico Para Hielo	319
Dosificador Para Miel/Leche	316	Mandil	201, 202, 205	Pictogramas	293
Dosificador, Inox	429	Mandolina	85 >87	Pincel	81, 113, 435
Embudo	72	Mangas Para Decorar	425 >426	Pinza	417
Embudo Colador	429	Mantelín Individual	283	Pinza Barbacoa	69
Enfriador Para Yogurt	368	Mantelín Para Sushi	127	Pinza Bogavante	287
Entremesera	342, 343, 348	Mantequera	91	Pinza Para Espinas	69
Escalera Para Buffet	370 >372	Máquina De Laminar/Cortar Pasta	94	Pinza, Pa+	58
Escoba	234, 242	Máquina Para El Envasado Al Vacío	158	Pinza, Pc	61
Escurridor Mural De Platos	212	Maquinaria Eléctrica	136 >158	Pinzas Para Mantel	283
Espátula De Madera	68	Máscaras Para Cacao	316	Pinzas Servir	267 >270
Espátula Monobloc	66	Medidor De Cóctel	320	Pirámide, Inox	354
Espátula Para Alisar	431	Mesa Cambio-Pañales	238	Pistola Eléctrica	429
Espátula Para Biscuit	431	Miniaturas	25, 28, 30	Pizarra Natural	274, 275
Espátula, Pa+	57 >60	Módulo Para Fuentes	361	Placa Anti-Adherente Siliconada	428
Espejo Acrílico	357	Molde Cubitos De Hielo Esféricos	319	Placa Caliente Platos	156
Espumadera De Alambre	67, 68, 132	Molde Para Helado	313	Placa Para Pastelería Monoporción	451
Espumadera Monobloc	66	Molde Para Pan	170	Placa Pastelería, Aluminio	428
Espumadera, Pa+	58, 59	Molde Para Sushi	127	Placa Pizza	165 >167
Exhibidor, Apilable	329	Molde Ravioli	94	Placas Eutécticas	222, 221, 362
Expositor	22	Moldes Chocolate	452 >460	Placas Inducción	155, 156, 386
Expositor Caliente	140	Moldes Flexipan	466 >476	Plancha Hasadora	137

Plancha Refrigerante	222, 221, 362	Salamandra	139	Tenedores	431
Plano Cocción A Gas	140	Salero Y Pimentero	282, 283	Termometro	100 >103
Plataforma/Taburete Escalera	229, 243	Salinometro	103	Termometro Vino	290
Platito Bajo Botellas	249	Salsera Con Pie	280	Termorgulador	387
Platito Bajo Vasos	249	Samovar	394	Tetera	247
Plato Caracoles	288	Sartén Antiadherente	4, 12, 18	Tijeras	85, 163, 267
Plato De Presentación	249	Sartén Balti	129	Timbre Recepción	294
Plato Para Pan	248	Sartén Tawa	130	Timer Digital	102, 103
Plato Parrilla	71	Sartén Toban	125	Tostador De Pan	139
Plato, Melamina	121 >124	Sartén, Aluminio	17, 19, 28	Tritador De Carne	154
Plato, Pc	213	Sartén, Cobre	24, 26	Trituradora De Hielo	152, 319
Ponchero	377, 387	Sartén, Hierro	21, 22	Unidad Temperator	429
Porcelana, Arthur Krupp	252 >259	Sartén, Inox	4, 7, 12	Usuba	134
Porta Canutillos	248	Secador Mangas/Boquillas	427	Utensilios De Cocina	107 >119
Porta Cucharas	248	Secador Para Verduras	77	Utensilios Decoración	80, 81, 84, 87 >89
Porta Cuchillos	194	Señal De Peligro	235	Utensilios Para Servicio, Serie Living	267 >270
Porta Platos	212	Servicio De Mesa	283	Vaciador	81, 113
Porta Tostadas	274	Servicio Para Fondues	25, 285	Vaporera	128, 130
Porta-Vela Antiviento	292	Servilletero	248, 283, 317	Varilla Portaperiodico	89
Poster 'La Cuisine'	89	Sierra De Cocina	197	Vaso Para Coctelera	321, 322
Prensa Ajos	86	Sifón Agua De Seltz	316	Vasos	212, 336 >338
Prensa Para Hamburguesa	198	Sifón Montador De Nata	313, 314	Vasos Gourmet	276, 346
Prensador Para Canard	78	Silform	477	Vertedor	326
Prensador Para Pulpo	79	Silla Niños	239	Vitrina Bocadillos	328
Procesador Alimentos	145 >147	Silpain	438	Vitrina De Mesa	328, 329
Pulse, Sistema De Limpieza	234	Silpat	438	Vitrina Para Puros	294
QRS	pag.	Sopera	123, 280	Vitrina Para Tapas	127
Quemador	157, 429	Soplete Cocina	383	Vitrina Refrigerada	329, 361, 367, 368
Quesera	283	Soporte Bandejas	334	Waflera	142
Quick Cart	232	Soporte Botellas	325	Wok	12, 22, 128, 129
Quita Pepa/Hueso	86	Soporte Cesta Pan	174, 175	Yanagi Sashimi	134
Rack Para Aceite Y Vinagre	249	Soporte Confituras	249		
Rack Para Botellas	70	Soporte Cubitera	288		
Rack Para Suelo	217	Soporte De Bufet	355		
Rallador	85, 93, 94, 115, 132	Soporte Dulces	249, 317		
Raspadores	436	Soporte Huevos	274		
Réchaud	285	Soporte Mangas	425		
Recipiente Reserva	323	Soporte Menù	292		
Recipiente Vertedor	323	Soporte Platos Pastre Bufet	352 >354		
Recogedor	234, 242	Soporte Platos, Cromado	345, 365		
Recogemigas	286	Soporte Rotatorio	275		
Red Cabello, Tnt	205	Soporte Termometro Azúcar	431		
Regla	431	Stencil	451		
Reja Para Cubetas	44	Sujeta Jamones	198		
Rejilla	44, 428	Sushi Bridge	125		
Rejilla Horno Esmaltada	44	TUVVY	pag.		
Rejilla Para Galleta	449, 450	Tabla De Corte	124, 199, 200, 277, 361		
Rejilla Para Pizza	164, 166	Tabla De Madera	30, 31		
Rejilla Para Tempura	129	Tabla, Melamina	276 >279		
Rejilla Pasteles	427	Tabla, Poliéster	276 >278		
Reloj De Pared	103	Tako Sashimi	134		
Ribeteador De Vasos	324	Tapa Roll-Top	329, 361, 366		
Rodillo	433 >435	Tapa, Aluminio	17		
Rollo/Hojas Acetato	437	Tapa, Cobre	24, 26		
Roul'Pat	438	Tapa, Inox	4, 7, 12		
Ruedecilla Pasta	107, 114, 433	Tapete Para Vasos	321		
Runner	283	Tapón Champaña/Vino	326, 327		
Rustidera	13, 19, 24	Tapón Dosificador	325		
Ruzador De Mantequilla	81, 113	Taza, Pc	213		
Saca Corazón De Piña	81	Tela De Cocción Silicona	437, 438		
Sacachorcoc	327, 328	Tenedor Monobloc	66		

**INDICE NUMERICO
NUMERICAL INDEX
NUMERISCH INDEX
INDEX NUMERIQUE
INDICE NUMERICO**

INDICE NUMERICO NUMERICAL INDEX NUMERISCH INDEX INDEX NUMERIQUE

Cod.	pag.	Cod.	pag.	Cod.	pag.	Cod.	pag.
11001-16	7	11014-28	7	11112-20	4	11704-06	160
11001-18	7	11014-32	7	11112-24	4	11704-13	160
11001-20	7	11014-36	7	11113-18	4	11704-16	160
11001-22	7	11014-40	7	11113-20	4	11705-02	160
11001-24	7	11061-16	7	11113-24	4	11705-06	160
11001-28	7	11061-18	7	11113-26	4	11705-10	160
11001-32	7	11061-20	7	11114-20	4	11705-14	160
11001-36	7	11061-22	7	11114-24	4	11706-02	160
11001-40	7	11061-24	7	11114-28	4	11706-06	160
11001-45	7	11061-28	7	11114-32	4	11706-10	160
11001-50	7	11061-32	7	11114-36	4	11706-14	160
11001-60	7	11061-36	7	11114-40	4	11710-AA	22
11006-12	7	11061-40	7	11114-45	4	11710-AB	22
11006-14	7	11061-45	7	11115-20	4	11713-32	128
11006-16	7	11061-50	7	11115-24	4	11713-40	128
11006-18	7	11101-16	3	11115-28	4	11714-20	21
11006-20	7	11101-20	3	11115-32	4	11714-22	21
11006-22	7	11101-24	3	11115-36	4	11714-24	21
11006-24	7	11101-28	3	11115-40	4	11714-26	21
11006-28	7	11101-32	3	11115-45	4	11714-28	21
11006-32	7	11101-36	3	11115-50	4	11714-32	21
11006-36	7	11101-40	3	11117-20	4	11714-36	21
11007-16	7	11101-45	3	11117-24	4	11714-40	21
11007-18	7	11101-50	3	11117-28	4	11714-45	21
11007-20	7	11102-28	3	11117-32	4	11714-50	21
11007-22	7	11102-32	3	11117-36	4	11715-12	22
11007-24	7	11102-36	3	11117-40	4	11716-16	21
11007-28	7	11102-40	3	11119-20	3	11716-20	21
11007-32	7	11102-45	3	11119-24	3	11716-22	21
11007-36	7	11102-50	3	11119-28	3	11716-24	21
11007-40	7	11105-16	3	11119-32	3	11716-26	21
11007-45	7	11105-20	3	11123-20	3	11716-28	21
11007-50	7	11105-24	3	11123-24	3	11716-32	21
11007-60	7	11105-28	3	11123-28	3	11716-36	21
11008-16	7	11105-32	3	11161-14	4	11716-40	21
11008-18	7	11105-36	3	11161-16	4	11716-45	21
11008-20	7	11105-40	3	11161-20	4	11717-34	21
11008-24	7	11106-14	3	11161-24	4	11717-37	21
11008-28	7	11106-16	3	11161-28	4	11717-42	21
11008-32	7	11106-20	3	11161-32	4	11717-47	21
11008-36	7	11106-24	3	11161-36	4	11718-20	22
11009-16	7	11106-28	3	11161-40	4	11718-22	22
11009-18	7	11106-32	3	11161-45	4	11718-24	22
11009-20	7	11106-36	3	11161-50	4	11720-18	18
11009-24	7	11107-16	3	11161-60	4	11720-20	18
11009-28	7	11107-20	3	11617-20	18	11720-24	18
11009-32	7	11107-24	3	11617-24	18	11720-28	18
11009-36	7	11107-28	3	11617-28	18	11720-30	18
11009-40	7	11107-32	3	11617-32	18	11720-32	18
11009-45	7	11107-36	3	11617-36	18	11721-28	22
11009-50	7	11107-40	3	11618-20	19	11739-20	165
11009-60	7	11107-45	3	11618-24	19	11739-24	165
11010-16	6	11107-50	3	11618-28	19	11739-28	165
11010-18	6	11108-16	4	11618-32	19	11739-32	165
11010-20	6	11108-20	4	11618-36	19	11740-14	166
11010-24	6	11108-24	4	11619-20	19	11740-16	166
11011-16	6	11108-28	4	11619-24	19	11740-18	166
11011-18	6	11108-32	4	11619-28	19	11740-20	166
11011-20	6	11108-36	4	11619-32	19	11740-22	166
11011-24	6	11109-16	3	11619-36	19	11740-24	166
11012-16	6	11109-20	3	11701-02	160	11740-26	166
11012-18	6	11109-24	3	11701-06	160	11740-28	166
11012-20	6	11109-28	3	11701-10	160	11740-30	166
11012-24	6	11109-32	3	11701-13	160	11740-32	166
11013-18	6	11109-36	3	11701-16	160	11740-36	166
11013-20	6	11109-40	3	11702-02	160	11740-40	166
11013-24	6	11109-45	3	11702-06	160	11741-20	166
11013-26	6	11109-50	3	11702-10	160	11741-24	166
11014-20	7	11112-16	4	11702-16	160	11741-26	166
11014-24	7	11112-18	4	11704-02	160	11741-28	166

Cod.	pag.	Cod.	pag.	Cod.	pag.	Cod.	pag.
11741-32	166	11939-45	14	11967-20	65	12009-16	9
11742-16	166	11940-30	14	11967-24	65	12009-18	9
11742-18	166	11940-40	14	11968-18	65	12009-20	9
11742-20	166	11940-45	14	11968-20	65	12009-24	9
11742-22	166	11941-35	13	11968-24	65	12009-28	9
11742-24	166	11941-40	13	11969-02	66	12009-32	9
11742-26	166	11941-45	13	11969-06	65	12009-36	9
11742-28	166	11941-50	13	11969-37	65	12009-40	9
11742-30	166	11941-60	13	11970-01	66	12009-45	9
11742-32	166	11943-40	13	11970-06	65	12009-50	9
11742-36	166	11943-45	13	11970-08	65	12009-60	9
11742-40	166	11943-50	13	11970-09	65	12037-16	9
11742-45	166	11943-60	13	11970-10	65	12101-16	5
11742-50	166	11943-61	13	11970-11	65	12101-20	5
11744-20	165	11944-40	13	11970-12	65	12101-24	5
11744-24	165	11944-45	13	11970-14	65	12101-28	5
11744-28	165	11944-50	13	11970-16	65	12101-32	5
11744-32	165	11944-60	13	11971-01	67	12101-36	5
11750-11	44	11944-61	13	11971-08	66	12101-40	5
11760-11	44	11948-40	14	11971-10	66	12101-45	5
11910-12	14	11948-45	14	11971-12	66	12101-50	5
11910-14	14	11948-50	14	11971-14	66	12107-16	5
11910-16	14	11948-60	14	11971-16	66	12107-20	5
11910-18	14	11948-61	14	11971-18	66	12107-24	5
11910-20	14	11951-22	76	11971-20	66	12107-28	5
11911-12	14	11951-26	76	11971-25	66	12107-32	5
11911-14	14	11951-32	76	11972-10	66	12107-36	5
11911-16	14	11951-36	76	11972-12	66	12107-40	5
11911-18	14	11951-40	76	11973-01	67	12107-45	5
11911-20	14	11952-22	76	11973-10	66	12107-50	5
11913-16	14	11952-26	76	11973-12	66	12109-16	5
11913-20	14	11952-32	76	11974-50	66	12109-20	5
11913-24	14	11952-36	76	11974-70	66	12109-24	5
11913-28	14	11952-40	76	11975-01	66	12109-28	5
11917-28	15	11953-16	76	11975-50	66	12109-32	5
11917-34	15	11953-22	76	11975-99	66	12109-36	5
11922-36	15	11954-26	77	11976-50	66	12109-40	5
11922-40	15	11954-30	77	11976-99	66	12109-45	5
11923-36	15	11954-32	77	11982-01	66	12109-50	5
11924-18	75	11954-36	77	11982-38	65	12119-20	9
11924-20	75	11954-37	77	11983-37	66	12119-24	9
11924-22	75	11954-40	77	11983-38	65	12119-28	9
11924-24	75	11955-32	74	11984-38	65	12119-32	9
11924-28	75	11955-36	74	11985-34	66	12123-20	9
11926-22	75	11955-40	74	11990-16	67	12123-24	9
11926-26	75	11955-45	74	11991-16	67	12123-28	9
11927-24	74	11955-50	74	12001-16	9	12504-20	70
11927-28	74	11956-37	377	12001-18	9	12507-24	12
11927-32	74	11956-42	377	12001-20	9	12507-28	12
11927-36	74	11956-AA	377	12001-22	9	12508-24	12
11927-40	74	11956-AB	377	12001-24	9	12509-12	12
11927-45	74	11957-20	74	12001-28	9	12509-20	12
11927-50	74	11957-25	74	12001-32	9	12509-24	12
11928-32	75	11957-30	74	12001-36	9	12509-28	12
11928-36	75	11957-35	74	12001-40	9	12511-10	12
11928-40	75	11957-40	74	12001-45	9	12511-12	12
11929-20	78	11963-60	14	12001-50	9	12511-14	12
11929-24	78	11963-70	14	12001-60	9	12511-16	12
11930-24	74	11963-99	14	12007-16	9	12511-18	12
11930-28	74	11965-50	14	12007-18	9	12511-20	12
11930-32	74	11965-60	14	12007-20	9	12511-24	12
11930-36	74	11965-61	14	12007-22	9	12513-16	12
11930-40	74	11967-06	65	12007-24	9	12513-18	12
11930-45	74	11967-08	65	12007-28	9	12513-20	12
11930-50	74	11967-09	65	12007-32	9	12513-24	12
11932-20	78	11967-10	65	12007-36	9	12514-20	12
11932-24	78	11967-12	65	12007-40	9	12514-26	12
11939-27	14	11967-14	65	12007-45	9	12514-28	12
11939-30	14	11967-16	65	12007-50	9	12514-32	12
11939-40	14	11967-18	65	12007-60	9	12514-36	12

INDICE NUMERICO NUMERICAL INDEX NUMERISCH INDEX INDEX NUMERIQUE

Cod.	pag.	Cod.	pag.	Cod.	pag.	Cod.	pag.
12517-24	12	12640-28	68	12932-26	60	14006-00	210
12517-26	12	12641-14	68	12940-02	73	14007-00	210
12517-28	12	12641-16	68	12940-05	73	14008-00	210
12517-32	12	12641-18	68	12940-10	73	14010-00	210
12517-36	12	12641-20	68	12940-20	73	14011-00	209
12529-32	12	12641-24	68	12940-25	73	14013-00	210
12561-16	12	12641-28	68	12941-07	60	14015-08	210
12561-18	12	12642-28	68	12941-10	60	14101-02	41
12561-20	12	12903-30	57	12941-12	60	14101-04	41
12561-24	12	12903-40	57	12941-14	60	14101-06	41
12561-26	12	12903-45	57	12941-16	60	14101-10	41
12561-28	12	12905-25	57	12941-18	60	14101-15	41
12580-11	74	12905-30	57	12941-20	60	14101-20	41
12580-17	74	12905-35	57	12941-23	60	14102-02	41
12580-21	74	12905-40	57	12941-26	60	14102-04	41
12580-24	74	12905-45	57	12943-03	79	14102-06	41
12580-29	74	12905-50	57	12943-05	79	14102-10	41
12580-30	74	12906-35	57	12943-07	79	14102-15	41
12580-31	74	12907-07	57	12943-08	79	14102-20	41
12580-36	74	12907-08	57	12943-10	79	14103-02	41
12580-40	74	12908-30	57	12943-12	79	14103-04	41
12580-45	74	12908-35	57	12943-13	416	14103-06	41
12580-50	74	12908-40	57	12944-03	79	14103-10	41
12582-13	74	12909-12	57	12944-05	79	14103-15	41
12582-17	74	12909-23	57	12944-07	79	14103-20	41
12582-22	74	12915-25	57	12944-08	79	14104-06	41
12582-24	74	12915-26	57	12944-10	79	14104-10	41
12582-32	74	12915-35	57	12944-12	79	14104-15	41
12582-34	74	12915-45	57	12944-13	416	14105-02	41
12582-38	74	12916-25	57	12947-02	416	14105-04	41
12582-40	74	12916-33	57	12947-03	416	14105-06	41
12604-22	73	12917-25	57	12947-04	416	14105-10	41
12604-30	73	12920-01	58	12947-05	416	14105-15	41
12604-34	73	12920-05	58	12947-06	416	14105-20	41
12604-40	73	12920-10	58	12947-07	416	14107-06	41
12605-22	74	12920-11	58	12947-13	416	14107-10	41
12605-30	74	12920-15	58	12950-32	60	14107-15	41
12605-34	74	12920-16	58	12950-40	60	14107-20	41
12605-40	74	12921-01	57	12967-06	59	14108-06	41
12606-30	74	12921-05	57	12967-10	59	14108-10	41
12606-34	74	12921-10	57	12968-10	59	14108-15	41
12607-22	74	12921-15	58	12969-06	59	14108-20	41
12607-30	74	12926-35	60	12969-10	59	14109-06	41
12607-34	74	12927-35	60	12970-06	59	14109-10	41
12622-07	77	12927-45	60	12970-08	59	14109-15	41
12622-10	77	12928-25	60	12970-10	59	14109-20	41
12622-12	77	12928-30	60	12970-12	59	14110-06	41
12622-14	77	12928-35	60	12971-10	59	14110-10	41
12622-16	77	12928-40	60	12971-12	59	14112-10	41
12622-18	77	12928-45	60	12972-10	60	14112-15	41
12622-20	77	12928-50	60	12972-12	60	14112-20	41
12622-23	77	12928-55	60	12973-10	60	14115-10	41
12622-26	77	12928-60	60	12973-12	60	14115-15	41
12630-22	77	12929-25	60	12982-01	59	14115-20	41
12633-16	77	12929-30	60	12982-38	59	14117-10	41
12633-18	77	12929-35	60	12986-01	59	14117-15	41
12633-20	77	12929-40	60	12986-38	59	14117-20	41
12633-23	77	12929-45	60	12992-36	15	14118-10	41
12633-26	77	12930-51	58	12992-40	15	14118-15	41
12635-23	77	12930-52	58	14001-09	209	14118-20	41
12635-26	77	12930-62	58	14001-16	209	14119-10	41
12635-30	77	12930-63	58	14001-25	209	14119-15	41
12635-35	77	12930-68	58	14001-36	209	14142-10	41
12636-32	77	12930-69	58	14001-49	209	14142-15	41
12638-20	77	12930-74	58	14003-09	209	14142-20	41
12640-14	68	12930-77	58	14003-16	209	14145-10	41
12640-16	68	12930-78	58	14003-25	209	14145-15	41
12640-18	68	12931-51	59	14003-36	209	14145-20	41
12640-20	68	12931-53	59	14003-49	209	14147-10	41
12640-24	68	12932-22	60	14004-00	209	14147-15	41

Cod.	pag.	Cod.	pag.	Cod.	pag.	Cod.	pag.
14147-20	41	14305-06	43	14570-06	45	14709-06	48
14148-10	41	14362-02	43	14570-10	45	14709-10	48
14148-15	41	14362-04	43	14571-00	45	14709-15	48
14148-20	41	14362-06	43	14572-00	45	14710-06	48
14151-10	41	14365-02	43	14575-00	45	14710-10	48
14151-15	41	14365-04	43	14577-00	45	14712-00	48
14151-20	41	14365-06	43	14578-00	45	14715-00	48
14152-06	41	14402-00	44	14579-00	45	14717-00	48
14152-10	41	14405-00	44	14580-00	45	14718-00	48
14152-15	41	14407-00	44	14585-00	45	14719-00	48
14152-20	41	14409-01	44	14591-00	45	14722-00	48
14155-10	41	14409-02	44	14592-00	45	14722-11	48
14155-15	41	14480-20	325	14595-00	45	14722-99	48
14155-20	41	14502-00	43	14597-00	45	14725-00	48
14157-10	41	14503-00	43	14598-00	45	14725-11	48
14157-15	41	14504-00	43	14599-00	45	14725-99	48
14157-20	41	14505-00	43	14661-20	47	14727-00	48
14158-10	41	14507-00	43	14662-06	47	14727-11	48
14158-15	41	14508-00	43	14662-10	47	14727-99	48
14158-20	41	14509-00	43	14662-15	47	14728-00	48
14159-10	41	14510-00	43	14662-20	47	14728-11	48
14159-15	41	14512-00	43	14665-06	47	14728-99	48
14159-20	41	14515-00	43	14665-10	47	14729-00	48
14162-02	43	14517-00	43	14665-15	47	14729-11	48
14162-04	43	14518-00	43	14665-20	47	14729-99	48
14162-06	43	14519-00	43	14667-06	47	14730-00	48
14165-02	43	14522-00	43	14667-10	47	14730-11	48
14165-04	43	14523-00	43	14667-15	47	14730-99	48
14165-06	43	14525-00	43	14667-20	47	14801-20	46
14201-02	42	14527-00	43	14668-06	47	14802-06	46
14201-04	42	14528-00	43	14668-10	47	14802-10	46
14201-06	42	14529-00	43	14668-15	47	14802-15	46
14201-10	42	14532-00	43	14668-20	47	14802-20	46
14201-15	42	14535-00	43	14669-06	47	14805-06	46
14201-20	42	14537-00	43	14669-10	47	14805-10	46
14202-02	42	14538-00	43	14669-15	47	14805-15	46
14202-04	42	14539-00	43	14669-20	47	14805-20	46
14202-06	42	14542-00	43	14670-06	47	14807-06	46
14202-10	42	14543-00	43	14670-10	47	14807-10	46
14202-15	42	14545-00	43	14671-00	47	14807-15	46
14202-20	42	14547-00	43	14672-00	47	14807-20	46
14203-06	42	14548-00	43	14675-00	47	14808-06	46
14203-10	42	14549-00	43	14677-00	47	14808-10	46
14203-15	42	14552-00	43	14678-00	47	14808-15	46
14203-20	42	14555-00	43	14679-00	47	14809-06	46
14205-02	42	14557-00	43	14680-00	47	14809-10	46
14205-04	42	14558-00	43	14682-00	47	14809-15	46
14205-06	42	14559-00	43	14685-00	47	14809-20	46
14205-10	42	14561-15	45	14687-00	47	14810-06	46
14205-15	42	14561-20	45	14688-00	47	14810-10	46
14205-20	42	14562-06	45	14689-00	47	14811-00	46
14252-06	42	14562-10	45	14690-00	47	14812-00	46
14252-10	42	14562-15	45	14691-00	47	14815-00	46
14252-15	42	14562-20	45	14692-00	47	14817-00	46
14252-20	42	14565-06	45	14695-00	47	14818-00	46
14255-06	42	14565-10	45	14702-06	48	14819-00	46
14255-10	42	14565-15	45	14702-10	48	14820-00	46
14255-15	42	14565-20	45	14702-15	48	14821-00	46
14255-20	42	14567-06	45	14702-20	48	14822-00	46
14301-02	43	14567-10	45	14705-06	48	14825-00	46
14301-04	43	14567-15	45	14705-10	48	14827-00	46
14301-06	43	14567-20	45	14705-15	48	14828-00	46
14302-02	43	14568-06	45	14705-20	48	14829-00	46
14302-04	43	14568-10	45	14707-06	48	14830-00	46
14302-06	43	14568-15	45	14707-10	48	14832-00	46
14303-02	43	14568-20	45	14707-15	48	14835-00	46
14303-04	43	14569-06	45	14707-20	48	14837-00	46
14303-06	43	14569-10	45	14708-06	48	14838-00	46
14305-02	43	14569-15	45	14708-10	48	14839-00	46
14305-04	43	14569-20	45	14708-15	48	14840-00	46

INDICE NUMERICO NUMERICAL INDEX NUMERISCH INDEX INDEX NUMERIQUE

Cod.	pag.	Cod.	pag.	Cod.	pag.	Cod.	pag.
14851-00	46	14958-02	319	15403-12	25	16117-20	18
14852-00	46	14959-01	61	15403-16	25	16117-24	18
14855-00	46	14959-02	61	15404-10	25	16117-28	18
14902-06	49	14959-05	61	15406-16	24	16117-32	18
14902-10	49	14959-10	61	15406-20	24	16117-36	18
14902-15	49	14959-21	61	15407-16	24	16117-40	18
14902-20	49	15100-01	50	15407-20	24	16118-24	19
14905-06	49	15100-02	50	15409-26	25	16120-24	18
14905-10	49	15100-03	50	15409-30	25	16120-28	18
14905-15	49	15100-04	50	15409-36	25	16120-32	18
14905-20	49	15100-AA	50	15412-25	24	16120-36	18
14907-06	49	15101-06	50	15415-03	25	16120-40	18
14907-10	49	15101-10	50	15428-06	285	16127-16	18
14907-15	49	15101-15	50	15430-11	25	16127-20	18
14907-20	49	15101-20	50	15438-50	24	16127-24	18
14908-06	49	15105-06	50	16101-16	16	16127-28	18
14908-10	49	15105-10	50	16101-20	16	16127-32	18
14908-15	49	15105-15	50	16101-24	16	16127-36	18
14908-20	49	15105-20	50	16101-28	16	16127-40	18
14909-06	49	15107-06	50	16101-32	16	16134-12	28
14909-10	49	15107-10	50	16101-36	16	16135-12	28
14909-15	49	15107-15	50	16101-40	16	16136-10	28
14909-20	49	15107-20	50	16101-45	16	16137-10	28
14910-06	49	15108-06	50	16101-50	16	16138-10	28
14910-10	49	15108-10	50	16106-16	17	16139-10	28
14912-00	49	15108-15	50	16106-20	17	16147-20	18
14915-00	49	15108-20	50	16106-24	17	16147-24	18
14922-00	50	15109-06	50	16106-28	17	16147-28	18
14922-00	49	15109-10	50	16107-16	16	16147-32	18
14922-11	50	15109-15	50	16107-20	16	16147-36	18
14922-11	49	15109-20	50	16107-24	16	16147-40	18
14922-22	49	15110-06	50	16107-28	16	16302-02	43
14922-33	49	15110-10	50	16107-32	16	16302-04	43
14922-99	49	15206-16	26	16107-36	16	16302-06	43
14925-00	50	15206-20	26	16107-40	16	16303-02	43
14925-00	49	15207-16	26	16107-45	16	16303-04	43
14925-11	50	15207-20	26	16107-50	16	16303-06	43
14925-11	49	15207-26	26	16108-20	17	16305-02	43
14925-22	49	15208-24	26	16108-24	17	16305-04	43
14925-33	49	15208-26	26	16108-28	17	16305-06	43
14925-99	49	15209-24	26	16109-24	16	16362-02	43
14927-00	49	15209-26	26	16109-28	16	16362-04	43
14927-11	50	15209-30	26	16109-32	16	16362-06	43
14927-11	49	15214-26	26	16109-36	16	16363-02	43
14927-22	50	15215-26	26	16109-40	16	16363-04	43
14927-22	49	15261-16	26	16109-45	16	16363-06	43
14927-33	49	15261-20	26	16109-50	16	16365-02	43
14927-99	49	15261-24	26	16109-60	16	16365-04	43
14928-00	49	15261-26	26	16113-20	19	16365-06	43
14928-11	50	15261-30	26	16113-24	19	16712-22	19
14928-11	49	15301-22	23	16113-28	19	16712-26	19
14928-22	50	15306-07	25	16113-32	19	16712-30	19
14928-22	49	15306-10	25	16113-36	19	16717-20	19
14928-33	49	15309-07	25	16113-40	19	16717-24	19
14928-99	49	15309-26	24	16114-20	17	16717-28	19
14929-00	49	15309-30	24	16114-24	17	16717-32	19
14929-11	50	15314-22	24	16114-28	17	16717-36	19
14929-11	49	15314-26	24	16114-32	17	16717-40	19
14929-22	50	15314-30	24	16114-36	17	16719-12	19
14929-22	49	15314-36	24	16114-40	17	16910-14	20
14929-33	49	15315-26	24	16115-24	17	16910-16	20
14929-99	49	15315-30	24	16115-28	17	16910-18	20
14930-00	49	15315-36	24	16115-32	17	16910-20	20
14930-11	50	15338-38	24	16115-36	17	16923-32	17
14930-11	49	15339-36	24	16115-40	17	16923-36	17
14930-22	50	15343-36	24	16115-45	17	16923-40	17
14930-22	49	15361-22	24	16116-28	18	16924-20	75
14930-33	49	15361-26	24	16116-32	18	16924-24	75
14930-99	49	15361-30	24	16116-36	18	16924-28	75
14958-01	319	15401-51	24	16116-40	18	16926-32	17

Cod.	pag.	Cod.	pag.	Cod.	pag.	Cod.	pag.
16926-36	17	18002-22	184	18104-18	181	18274-00	192
16926-40	17	18002-26	184	18106-15	181	18275-00	192
16927-32	75	18002-30	184	18106-20	181	18276-00	162
16927-36	75	18002-36	184	18106-25	181	18280-10	134
16927-40	75	18005-22	184	18106-30	181	18280-16	134
16927-45	75	18005-27	184	18109-26	181	18280-22	134
16927-50	75	18005-32	184	18109-30	181	18281-24	134
16929-36	20	18006-20	184	18109-36	181	18282-18	134
16929-40	20	18006-25	184	18110-26	181	18282-19	134
16938-36	17	18006-30	184	18110-30	181	18282-22	134
16938-40	17	18006-36	184	18110-36	181	18283-27	134
16938-45	17	18007-25	184	18111-30	181	18283-33	134
16939-50	20	18007-30	184	18112-30	181	18284-21	134
16939-60	20	18007-36	184	18114-20	181	18284-27	134
16939-70	20	18008-20	184	18115-20	182	18284-30	134
16939-80	20	18008-26	184	18115-25	182	18284-33	134
16940-28	441	18008-30	184	18116-14	182	18301-01	163
16940-32	441	18008-36	184	18116-18	182	18301-02	163
16940-36	441	18009-25	185	18122-12	182	18302-01	163
16940-40	441	18009-30	185	18123-11	182	18302-02	163
16941-40	19	18009-36	185	18124-09	182	18323-00	162
16941-45	19	18010-25	185	18125-07	182	18324-00	162
16941-50	19	18010-30	185	18125-10	182	18324-10	107
16941-60	19	18010-36	185	18126-07	182	18325-01	433
16941-61	19	18011-32	185	18128-20	182	18325-02	433
16943-40	19	18012-32	185	18128-24	182	18325-03	433
16943-45	19	18013-30	185	18128-30	182	18501-01	164
16943-50	19	18013-36	185	18190-09	193	18501-02	164
16943-60	19	18015-18	185	18191-22	194	18501-03	164
16943-61	19	18015-22	185	18192-09	194	18501-04	164
16944-45	20	18015-27	185	18199-19	193	18501-05	164
16944-50	20	18016-14	185	18201-36	188	18502-18	164
16944-60	20	18016-16	185	18203-26	189	18503-12	164
16947-40	20	18017-14	185	18205-10	188	18504-15	164
16947-45	20	18017-16	185	18205-12	188	18509-01	62
16947-50	20	18017-18	185	18206-09	188	18509-02	62
16947-60	20	18018-11	185	18207-15	188	18509-03	62
16947-61	20	18019-12	185	18209-06	188	18510-07	62
16948-40	20	18019-14	185	18215-13	189	18511-15	63
16948-45	20	18019-16	185	18215-21	189	18512-15	63
16948-50	20	18019-18	185	18216-22	63	18513-14	63
16948-60	20	18019-20	185	18217-12	189	18514-17	63
16948-61	20	18020-23	186	18218-12	189	18514-18	63
16961-16	17	18021-18	186	18220-18	187	18515-16	63
16961-20	17	18022-12	186	18220-20	187	18516-24	63
16961-24	17	18023-11	186	18220-22	187	18517-24	63
16961-28	17	18024-08	186	18220-26	187	18518-22	63
16961-32	17	18024-11	186	18221-17	187	18518-26	63
16961-36	17	18026-07	186	18221-19	187	18518-30	63
16961-40	17	18028-21	186	18221-21	187	18519-15	63
16961-45	17	18028-25	186	18222-18	188	18519-22	63
16961-50	17	18028-30	186	18224-28	187	18519-26	63
16961-60	17	18028-36	186	18225-28	188	18519-30	63
16965-40	20	18029-25	187	18226-17	190	18519-35	63
16965-50	20	18029-30	186	18227-00	85	18520-04	63
16965-60	20	18029-36	186	18230-13	182	18520-06	63
16971-36	22	18030-26	186	18230-17	182	18520-08	63
16971-47	22	18030-31	186	18231-13	182	18520-10	63
17610-01	73	18030-36	186	18235-26	190	18520-12	63
17610-02	73	18099-15	193	18235-30	190	18520-15	164
17610-05	73	18100-16	181	18236-30	190	19701-00	100
17610-10	73	18100-20	181	18237-26	190	19702-00	100
18000-16	184	18100-24	181	18251-01	190	19705-00	100
18000-20	184	18100-30	181	18251-02	190	19706-00	100
18000-23	184	18100-36	181	18255-00	195	19709-00	100
18000-26	184	18102-16	181	18261-00	192	19810-00	98
18000-30	184	18102-20	181	18263-00	192	19811-00	98
18000-40	184	18102-26	181	18271-00	192	19901-35	334
18002-18	184	18102-30	181	18272-00	192	19901-40	334
18002-20	184	18103-18	181	18273-00	192	19901-47	334

INDICE NUMERICO NUMERICAL INDEX NUMERISCH INDEX INDEX NUMERIQUE

Cod.	pag.	Cod.	pag.	Cod.	pag.	Cod.	pag.
31509-01	290	41427-18	370	41472-01	309	41510-05	320
31559-04	288	41427-40	370	41472-04	309	41510-08	290
32931-02	291	41428-03	367	41472-05	309	41511-00	290
32931-03	291	41429-03	367	41472-10	310	41512-15	319
32931-05	291	41429-04	367	41472-11	310	41512-30	319
32935-03	291	41429-45	358	41472-15	310	41512-50	319
32935-05	291	41429-50	366	41472-16	310	41513-13	319
32935-10	291	41430-11	358	41472-20	310	41515-03	319
32935-22	291	41430-AA	358	41472-21	310	41518-00	288
32936-03	291	41435-58	358	41472-22	310	41518-01	288
32936-05	291	41436-11	358	41472-30	328	41518-02	288
41311-00	285	41436-12	358	41472-31	328	41523-08	343
41312-00	285	41437-11	358	41472-32	328	41524-04	343
41315-02	285	41437-12	358	41473-31	312	41524-09	343
41315-04	285	41438-50	358	41473-39	312	41525-00	317
41320-25	277	41438-60	358	41473-44	312	41525-01	316
41320-30	277	41438-70	358	41473-50	312	41526-B1	331
41320-35	277	41439-32	359	41473-56	312	41526-B2	331
41321-40	277	41439-38	359	41473-62	312	41526-B3	331
41321-44	277	41439-48	359	41473-66	312	41526-G1	331
41322-19	277	41442-01	369	41474-00	312	41526-G2	331
41322-25	277	41442-03	369	41474-01	312	41526-G3	331
41322-31	277	41442-14	369	41474-02	312	41526-R1	331
41323-01	278	41442-23	370	41475-00	312	41526-R2	331
41323-02	278	41447-02	367	41475-01	312	41526-R3	331
41323-03	278	41447-05	367	41475-03	312	41527-13	343
41323-04	278	41447-38	329	41475-04	312	41528-21	331
41323-11	278	41448-06	368	41475-05	312	41528-22	331
41323-12	278	41448-10	368	41476-50	312	41529-05	273
41323-13	278	41448-25	368	41477-50	321	41530-05	273
41323-14	278	41448-40	368	41478-35	322	41530-07	273
41323-21	278	41449-20	318	41478-50	322	41530-11	273
41323-22	278	41449-27	318	41479-05	321	41533-05	376
41323-23	278	41449-32	318	41479-11	321	41537-33	330
41323-24	278	41450-AA	313	41479-12	321	41537-34	330
41324-01	335	41451-05	313	41479-13	321	41538-20	377
41324-02	335	41451-10	313	41479-14	321	41538-24	377
41324-03	335	41453-07	316	41479-15	321	41538-30	377
41324-11	335	41453-11	316	41479-AA	322	41538-36	377
41324-12	335	41453-AA	316	41480-03	322	41541-44	377
41324-13	335	41455-AA	314	41480-05	322	41558-00	288
41324-21	335	41455-BC	314	41480-07	322	41560-28	286
41324-22	335	41455T55	314	41481-02	322	41561-09	279
41324-23	335	41456-00	318	41481-03	322	41562-18	288
41380-01	103	41456-02	318	41483-04	322	41563-07	280
41380-02	103	41457-00	319	41483-06	322	41564-07	279
41390-00	294	41458-02	314	41484-00	324	41566-09	279
41392-10	178	41458-05	314	41486-08	312	41569-33	285
41392B10	178	41458-10	314	41486-12	312	41569-45	285
41393-10	178	41458-11	315	41486-15	312	41582-00	198
41393B10	178	41458-21	315	41487-12	312	41583-00	198
41394-02	178	41458-23	315	41487-15	312	41585-00	275
41400-60	373	41458-24	315	41487-17	312	41585-01	275
41400-AA	361	41458-25	315	41498-02	290	41585-02	275
41400-AB	370	41458-50	315	41498-03	290	41585-03	275
41401-60	373	41458-51	315	41498-04	290	41585-10	275
41405-AA	361	41459-10	314	41499-00	327	41585-11	274
41405-AB	370	41460-05	314	41499-08	290	41585-12	274
41412-11	367	41460-10	314	41501-20	288	41585-13	274
41414-30	329	41466-01	313	41502-20	288	41585-24	275
41414-33	330	41466-02	313	41503-00	319	41585-25	275
41415-10	366	41466-03	313	41503-22	319	41585-30	275
41415-11	366	41468-20	312	41504-11	289	41585-45	275
41415-12	366	41468-24	312	41504-12	289	41585-51	276
41416-40	366	41469-20	312	41505-17	288	41585-52	276
41418-11	367	41469-24	312	41505-19	288	41585-53	276
41418-12	366	41471-00	312	41507-01	289	41585-54	276
41419-12	367	41471-12	312	41508-10	289	41586-22	275
41421-53	358	41471-15	312	41509-23	289	41586-28	275
41425-AA	370	41471-17	312	41509B23	289	41586-33	275

Cod.	pag.	Cod.	pag.	Cod.	pag.	Cod.	pag.
41586-38	275	41646-10	272	41695-50	393	41746-60	166
41587-25	275	41646-15	272	41695-90	393	41747-60	167
41587-32	275	41646-20	272	41697-00	69	41748-20	167
41587-38	275	41649-03	272	41698-22	69	41748-30	167
41589-14	276	41649-06	272	41698-30	69	41748-35	167
41589-16	276	41650-03	272	41698-40	69	41748-40	167
41589-22	276	41650-06	272	41699-03	327	41748-50	167
41589-25	276	41650-10	272	41699-04	327	41750-20	167
41589-50	276	41650-13	272	41699-06	328	41750-30	167
41589-99	276	41650B03	272	41699-08	328	41750-40	167
41589C08	346	41650B06	272	41699-10	328	41750-41	167
41589C16	346	41650B10	272	41699-11	328	41750-50	167
41591-32	287	41650B13	272	41699-12	327	41751-30	166
41591-36	287	41650R03	272	41699-13	327	41751-35	166
41591-40	287	41650R06	272	41707-32	22	41751-40	166
41591-45	287	41650R10	272	41707-36	22	41751-50	166
41591-90	287	41650R13	272	41707-40	22	41751-60	166
41592-36	287	41651-20	359	41707-45	22	41751-65	166
41592-45	287	41651-25	359	41707-50	22	41752-08	167
41593-20	287	41651-30	359	41708-32	22	41752-12	167
41594-12	287	41651-35	359	41708-36	22	41752-24	167
41594-18	287	41651-40	359	41708-40	22	41753-30	428
41595-20	320	41651-45	359	41708-45	22	41753-32	428
41597-04	274	41651-50	359	41708-50	22	41753-53	428
41598-00	274	41651-55	359	41717-60	22	41753-60	428
41599-08	274	41651-60	359	41717-80	22	41755-11	167
41601-17	317	41651-65	359	41719-32	22	41756-30	167
41603-00	320	41654-80	359	41719-36	22	41756-32	167
41604-00	320	41654-99	359	41719-40	22	41756-53	167
41605-00	320	41655-66	358	41720-18	18	41756-60	167
41605-25	270	41659-06	441	41720-20	18	41758-53	167
41606-00	318	41659-07	441	41720-24	18	41758-60	167
41606-01	318	41659-08	441	41720-28	18	41758-65	167
41606-02	318	41660-10	440	41720-30	18	41758-85	167
41607-00	316	41660-15	440	41720-32	18	41759-01	168
41608-00	326	41670-06	67	41727-28	166	41759-02	168
41608-03	327	41670-09	67	41727-30	166	41759-03	168
41608-04	326	41670-AA	67	41727-33	166	41759-05	168
41608-08	326	41670-AB	67	41727-36	166	41759-09	168
41613-45	395	41671-11	67	41727-40	166	41760-02	168
41614-22	394	41672-00	67	41727-45	166	41760-05	168
41614-33	394	41673-00	67	41727-50	166	41760-06	168
41614-34	394	41674-00	67	41727-55	166	41760-08	168
41614-35	394	41675-00	67	41727-60	166	41760-09	168
41614-36	394	41676-00	67	41729-30	165	41760-20	477
41615-01	280	41677-00	67	41729-34	165	41760-21	477
41615-03	280	41678-00	67	41734-60	164	41760-22	477
41615-05	280	41678-14	290	41735-20	161	41760-25	477
41617-05	317	41679-23	286	41735-29	160	41760-26	477
41617-15	317	41681-01	323	41736-32	160	41760-27	477
41618-14	317	41681-02	323	41737-17	161	41761-00	217
41620-04	280	41681-03	323	41737-20	161	41761-06	217
41624-00	281	41681-04	322	41737-23	161	41761-07	217
41625-23	317	41681-99	322	41738-17	161	41761-10	217
41628-15	292	41682-17	136	41738-20	161	41762-07	164
41629-17	281	41682-20	136	41738-23	161	41762-09	164
41629-20	281	41683-26	72	41739-20	161	41762-13	164
41629-25	281	41686-12	287	41740-00	161	41763-00	164
41635-00	282	41687-06	288	41743-32	428	41763-30	218
41635-01	282	41687-12	288	41743-53	428	41764-28	161
41636-25	282	41693A54	392	41743-60	428	41764-33	161
41636-30	282	41693E54	392	41744-32	428	41764-40	161
41638-01	283	41693U54	392	41744-53	428	41765-32	160
41638-02	283	41694A02	392	41744-60	428	41765-37	160
41638-04	283	41694A54	392	41745-30	166	41765-41	160
41638-12	283	41694E54	392	41745-35	166	41765-45	160
41638-13	283	41694A60	392	41745-40	166	41765-50	160
41639-25	283	41694U54	392	41745-50	166	41766-14	161
41645-00	316	41695-10	393	41745-60	166	41766-16	161
41646-06	272	41695-15	393	41745-65	166	41766-27	161

INDICE NUMERICO NUMERICAL INDEX NUMERISCH INDEX INDEX NUMERIQUE

Cod.	pag.	Cod.	pag.	Cod.	pag.	Cod.	pag.
41767-20	161	41868W02	353	41914-03	15	42420-08	286
41768-21	161	41868W03	353	41916-10	77	42440-22	292
41768-22	161	41868W05	353	41916-15	77	42441-01	292
41769-00	162	41870-01	354	41916-20	77	42441-02	292
41769-01	162	41870-02	354	41918-01	371	42443-06	291
41769-02	162	41870-03	354	41918-02	371	42443-08	291
41769-36	162	41870-04	354	41918-03	371	42443-10	291
41769-50	162	41875-40	357	41918-04	371	42450-00	361
41770-15	166	41875-61	357	41918-05	371	42450-14	362
41771-96	166	41875-80	357	41919-03	355	42450-16	363
41773-00	70	41876-30	357	41920-03	374	42450-18	363
41774-33	163	41876-38	357	41920-05	374	42450-20	363
41774-40	163	41876-45	357	41925-14	78	42450-AD	362
41774-45	163	41876-58	357	41925-16	78	42451-11	361
41774-50	163	41876-81	357	41925-18	78	42451-12	361
41775-34	163	41876-99	357	41925-20	78	42452-14	361
41775-45	163	41877-45	357	41925-22	78	42452-23	361
41775-50	163	41877-61	357	41925-24	78	42452-35	363
41780-07	160	41877-81	357	41925-26	78	42452-53	361
41780-10	160	41877-99	357	41929-00	68	42453-23	361
41780-15	160	41878-45	357	41930-39	20	42460-00	361
41780-20	160	41878-61	357	41931-08	78	42460-03	361
41781-05	160	41878-81	357	41931-14	78	42460-06	361
41781-10	160	41878-99	357	41931-16	78	42460-10	362
41781-15	160	41879-30	357	41931-18	78	42460-12	362
41782-04	321	41879-40	357	41932-05	78	42460-14	362
41782-05	321	41879-50	357	41933-18	78	42460-16	363
41782-06	321	41879-61	357	41940-06	368	42460-18	363
41809-09	393	41880-38	357	41940B06	368	42460-20	363
41810-04	373	41880-61	357	41941-40	368	42460-24	364
41810-09	374	41881-30	357	41941-43	368	42460-26	364
41820-03	375	41881-40	357	41941-44	368	42460-27	364
41822-48	358	41882-15	357	41944-06	368	42460-43	364
41822-53	358	41882-20	357	41944B06	368	42460-45	364
41830-37	333	41882-25	357	41945-38	368	42460-53	363
41830-53	333	41882-30	357	41960-08	76	42460-57	361
41831-28	333	41885-30	357	41960-10	76	42460-63	364
41831-43	333	41885-40	357	41960-12	76	42460-74	364
41831-46	333	41885-45	357	41960-15	76	42460-76	364
41831-61	333	41885-50	357	41961-10	76	42461-11	174
41833-32	333	41885-60	357	41961-12	76	42461-35	174
41833-38	333	41885-75	357	41961-15	76	42470-00	361
41833-43	333	41900-04	375	41962-10	76	42470-03	361
41840-37	333	41900-10	375	41962-12	76	42470-06	361
41840-53	333	41901-08	374	41962-15	76	42470-07	361
41841-27	333	41901-16	375	41964-45	14	42470-10	362
41841-46	333	41902-04	374	41964-60	14	42470-12	362
41841-61	333	41902-06	374	41980-99	70	42470-14	362
41843-32	333	41903-10	395	41989A00	392	42470-16	363
41843-38	333	41904-10	375	41989A01	392	42470-18	363
41845-36	333	41905-03	367	42400-19	375	42470-20	363
41850-37	334	41905-38	367	42400-25	375	42470-24	364
41850-53	334	41906-60	367	42400-30	375	42470-26	364
41851-46	334	41907-02	374	42401-10	272	42470-27	364
41860-36	334	41907-04	374	42401-15	272	42470-43	364
41860-43	334	41907-06	374	42401-20	272	42470-45	364
41860-47	334	41907-56	367	42402-06	272	42470-53	363
41861-44	334	41908-00	373	42402-10	272	42470-63	364
41865-10	353	41908-01	373	42402-15	272	42470-64	364
41865-20	353	41909-08	373	42402-20	272	42470-74	364
41865-30	353	41909-13	373	42406-35	375	42470-76	364
41866-04	353	41910-03	374	42406-40	375	42501-15	197
41868-04	353	41910-05	374	42414-05	286	42501-20	197
41868K00	352	41911-02	373	42414-10	286	42502-11	197
41868K01	352	41911-03	373	42414-15	286	42503-10	197
41868K02	353	41911-04	373	42414-20	286	42504-09	70
41868K03	353	41912-03	370	42415-09	285	42504-20	70
41868K05	353	41912-04	370	42417-22	285	42505-21	197
41868W00	352	41913-03	370	42420-01	286	42505-24	197
41868W01	352	41913-04	370	42420-04	286	42505-27	197

Cod.	pag.	Cod.	pag.	Cod.	pag.	Cod.	pag.
42505-50	197	42531-50	198	42562-20	72	42587-04	210
42506-08	197	42532-29	198	42562-25	72	42588-00	83
42506-10	197	42532-58	198	42562-30	72	42588-01	83
42506-12	197	42533-23	437	42563-00	86	42589-00	84
42506-14	197	42533-26	437	42563-44	86	42590-01	73
42506-16	197	42533-31	437	42565-00	86	42590-02	73
42506-18	197	42533-33	437	42566-03	84	42590-03	73
42507-12	196	42533-40	437	42569-04	94	42590R01	73
42508-00	197	42534-26	198	42570-32	97	42590R02	73
42508-01	197	42534-32	198	42571-20	97	42590R03	73
42509-25	70	42534-41	198	42572-24	97	42591-02	73
42509-50	70	42535-24	200	42573-31	97	42591-03	73
42509-60	70	42535-32	200	42574-37	97	42591R02	73
42509-99	70	42535-49	200	42575-37	97	42591R03	73
42510-00	197	42537-40	200	42576-00	96	42592-01	69
42511-20	196	42537-50	200	42577-39	96	42592-02	69
42511-25	196	42537-80	200	42579-00	198	42593-00	286
42511-30	196	42538-00	199	42579-01	198	42595-01	83
42511-35	196	42538-01	199	42581-01	73	42596-02	84
42511-40	196	42538-02	199	42581-03	73	42597-00	83
42511-56	196	42538-03	199	42581-05	73	42598-00	84
42511-60	196	42538-04	199	42581-10	73	42599-06	86
42511-70	196	42538-05	199	42581-15	73	42599-08	86
42512-35	71	42538-09	199	42581-20	73	42607-05	436
42512-90	227	42539-00	199	42582-01	356	42609-10	73
42512-91	227	42539-01	199	42582-02	356	42609-15	73
42512-92	227	42539-02	199	42582-03	356	42609-20	73
42513-30	71	42539-03	199	42582-04	356	42609-23	73
42513-45	71	42539-04	199	42582-05	356	42609-25	73
42514-20	196	42539-05	199	42582-06	356	42614-04	170
42515-18	196	42539-09	199	42582-07	356	42614-05	170
42515-20	196	42540-40	200	42582-08	356	42614-06	170
42516-18	196	42540-50	200	42582-09	356	42614-07	170
42516-20	196	42540-80	200	42582-10	356	42614-21	436
42517-06	196	42541-06	200	42582-11	356	42615-04	73
42518-01	199	42542-00	200	42582-12	356	42616-04	73
42518-50	199	42543-00	200	42582-13	356	42617-04	273
42519-01	199	42543-01	200	42582-14	356	42617-05	273
42520-00	200	42543-02	200	42582-15	356	42617-06	273
42521-16	199	42543-03	200	42582-21	356	42617-07	273
42521-24	199	42543-04	200	42582-22	356	42619-02	273
42522-00	199	42543-05	200	42582-23	356	42623-10	67
42522-01	199	42544-00	200	42582-24	356	42642-20	68
42522-02	199	42544-01	200	42582-25	356	42650-10	84
42522-03	199	42544-02	200	42582B01	356	42650-11	84
42522-04	199	42544-03	200	42582B02	356	42651-10	84
42522-05	199	42544-04	200	42582B03	356	42653-04	78
42522-09	199	42544-05	200	42582B04	356	42660-02	298
42523-00	196	42546-00	200	42582B05	356	42661-01	303
42524-06	197	42546-01	200	42582B06	356	42661-02	303
42524-08	197	42546-02	200	42582B07	356	42661-03	303
42524-10	197	42546-03	200	42582B08	356	42661-04	303
42524-12	197	42546-04	200	42582B09	356	42661-05	303
42524-14	197	42546-05	200	42582B10	356	42661-06	303
42524-16	197	42555-11	132	42582B11	356	42662C14	304
42524-18	197	42556-00	94	42582B12	356	42662P14	304
42524-20	197	42558-00	97	42582B13	356	42662S14	304
42524-22	197	42560-01	93	42582B14	356	42663C14	305
42524-30	197	42560-02	93	42582B15	356	42663P14	305
42525-27	197	42560-03	93	42584-01	281	42663S14	305
42526-12	197	42560-04	93	42584-02	281	42664P12	300
42526-14	197	42560-05	93	42584-04	281	42664P18	300
42529-06	196	42560-06	93	42584-05	282	42664P22	300
42530-26	198	42560-07	93	42584-06	282	42664P30	300
42530-32	198	42560-08	93	42584-07	282	42664P40	300
42530-41	198	42560-09	93	42585-00	210	42664S12	300
42530-50	198	42562-12	72	42585-04	210	42664S18	300
42531-26	198	42562-14	72	42585-06	210	42664S22	300
42531-32	198	42562-16	72	42586-09	210	42664S30	300
42531-41	198	42562-18	72	42586-10	210	42665P12	300

INDICE NUMERICO NUMERICAL INDEX NUMERISCH INDEX INDEX NUMERIQUE

Cod.	pag.	Cod.	pag.	Cod.	pag.	Cod.	pag.
42665P18	300	42710-11	302	42786R20	298	42901-40	68
42665P22	300	42720-00	305	42786S20	298	42902-30	69
42665P27	300	42720-01	305	42792P15	301	42902-31	69
42665P30	300	42720-02	305	42792S15	301	42903-29	70
42665P40	300	42720-03	305	42796P16	304	42904-01	69
42665S12	300	42723P10	305	42796P23	304	42904-02	69
42665S18	300	42723S10	305	42796P30	304	42904-03	69
42665S22	300	42725P10	305	42796S16	304	42907-01	68
42665S27	300	42725S10	305	42796S23	304	42907-02	68
42665S30	300	42727-09	304	42796S30	304	42907-03	68
42665S40	300	42727-12	304	42798P11	304	42907-04	68
42666P12	300	42727-18	304	42798P16	304	42907-06	68
42666P18	300	42727-22	304	42798S11	304	42907-07	68
42666P22	300	42727-30	304	42798S16	304	42907-08	68
42666P27	300	42727-38	304	42799P10	302	42907-09	68
42666P30	300	42728-09	304	42799S10	302	42907-10	68
42666P40	300	42728-12	304	42800P20	298	42907-30	68
42666S12	300	42728-18	304	42800S20	298	42907-35	68
42666S18	300	42728-22	304	42801P14	298	42907-40	68
42666S22	300	42728-30	304	42801S14	298	42920-02	316
42666S27	300	42728-38	304	42822-00	162	42921-00	283
42666S30	300	42741-22	299	42826-32	163	42923-07	316
42666S40	300	42742-22	299	42826-37	163	42924-02	282
42667P12	300	42746P12	299	42826-41	163	42924-12	282
42667P18	300	42746P18	299	42826-45	163	42925-04	282
42667P22	300	42746P22	299	42827-01	163	42927-02	282
42667P30	300	42746P30	299	42827-02	163	42928-00	282
42667S12	300	42746P40	299	42827-03	163	42930P00	282
42667S18	300	42746P50	299	42827-04	163	42930S00	282
42667S22	300	42746P80	299	42854B25	69	42931-19	281
42667S30	300	42746S18	299	42854B30	69	42931-23	281
42668P12	300	42746S22	299	42854C25	69	42932-15	281
42668P18	300	42746S30	299	42854C30	69	42932-20	281
42668P22	300	42747P12	299	42854G25	70	42932-30	281
42668P30	300	42747P18	299	42854G30	70	42935-19	175
42668P40	300	42747S12	299	42854K25	70	42935-26	175
42668S12	300	42747S18	299	42854K30	70	42936-23	174
42668S18	300	42749P18	299	42854R25	70	42936-24	174
42668S22	300	42749P22	299	42854R30	70	42936-28	174
42668S30	300	42749P30	299	42854Y25	69	42939-15	292
42669C14	304	42749S18	299	42854Y30	69	42940-03	375
42669P14	304	42749S22	299	42863-00	69	42941-22	292
42669S14	304	42764P16	302	42864-00	198	42941-32	292
42670B14	304	42764P21	302	42864-10	198	42942-16	292
42670N14	304	42764S16	302	42870-50	365	42943-13	292
42670W14	304	42764S21	302	42870-59	175	42944-23	175
42671P15	304	42766P12	302	42871-02	175	42945-18	175
42671S15	304	42766P15	302	42871-03	175	42945-23	175
42672P22	301	42766P20	302	42872-02	174	42945-27	175
42672S22	301	42766S12	302	42873-01	177	42946-23	174
42692B14	298	42766S15	302	42873-02	177	42946-37	174
42693B14	298	42766S20	302	42873-65	366	42947-23	174
42701-10	299	42767P12	302	42874-01	178	42947-30	174
42701P10	299	42767P15	302	42874-02	178	42947-40	174
42701S10	299	42767P20	302	42874-03	178	42948-18	175
42702-10	299	42767S12	302	42874-04	178	42948-20	175
42702P10	299	42767S15	302	42875-17	177	42948-23	175
42702S10	299	42767S20	302	42875-20	177	42948-25	175
42703-10	299	42780P15	302	42875B17	177	42949-26	175
42704-10	299	42780S15	302	42875B20	177	42950-01	284
42705P10	299	42781-23	301	42876-20	177	42950-02	284
42705P16	301	42781-30	301	42876-25	177	42950-03	284
42705P21	301	42782-23	301	42876B20	177	42950-04	284
42705S10	299	42782-30	301	42876B25	177	42950-05	284
42705S16	301	42783-23	301	42900-15	68	42950-06	284
42705S21	301	42783-30	301	42900-24	68	42950-07	284
42707P21	301	42784-23	301	42901-20	68	42950-08	284
42707S21	301	42784-30	301	42901-25	68	42950-09	284
42709P21	301	42785R20	298	42901-30	68	42950-92	283
42709S21	301	42785S20	298	42901-35	68	42950-93	283

Cod.	pag.	Cod.	pag.	Cod.	pag.	Cod.	pag.
42950-94	283	42967-43	172	42992N28	176	44060-02	324
42951-08	292	42967-53	173	42992N40	176	44060-50	70
42951-57	293	42967-63	173	42993-30	176	44060-51	324
42951-58	293	42967-64	173	42993-40	176	44060-80	70
42951-59	293	42967-65	173	42993M30	176	44060-99	324
42952-05	292	42967-66	173	42993M40	176	44061-08	70
42953-04	283	42967-67	173	42993N30	176	44061-09	70
42954-04	292	42967-68	173	42993N40	176	44061-12	70
42954-18	292	42967-73	173	42994-26	177	44061-14	70
42954-29	292	42967-74	173	42994-31	177	44077-00	242
42954-46	292	42967-75	173	42994M26	177	44077-CC	235
42955-00	283	42967-76	173	42994M31	177	44077-CE	235
42956-19	281	42967-77	173	42994N26	177	44089-12	242
42956-24	281	42967-78	173	42994N31	177	44093-00	334
42956-28	281	42968-26	173	44009-00	211	44093-01	334
42958-00	293	42968-37	172	44020-01	211	44094-00	226
42958-01	293	42968-38	172	44020-10	211	44094-01	226
42958-02	293	42968-42	172	44020-21	211	44094-02	226
42958-03	293	42969-11	175	44023-00	211	44094-03	226
42958-04	293	42969-31	172	44024-00	211	44094-04	226
42958-05	293	42969-36	172	44025-50	211	44094-05	226
42958-11	293	42969-42	172	44026-60	230	44094-06	227
42958-12	293	42969-46	172	44027-00	212	44094-20	229
42958-13	293	42971-32	358	44028-00	217	44095-01	230
42958-14	293	42971-52	358	44029-00	212	44095-03	230
42958-15	293	42971-53	358	44030-03	229	44095-04	230
42958-16	293	42972-01	173	44031-01	229	44095-05	228
42958-17	293	42972-02	173	44031-02	229	44095-06	228
42958-18	293	42972-03	173	44031-04	212	44095-07	228
42958-19	293	42972-04	173	44031-05	212	44095-12	242
42958-20	293	42972-28	172	44031B23	229	44095-18	242
42958-23	293	42972-29	172	44033-23	217	44096-12	242
42958-24	293	42972-40	171	44033-38	217	44097-00	243
42958-26	293	42972-60	171	44034-11	217	44097-08	243
42958-27	293	42973-30	171	44040-40	214	44098-29	236
42958-28	293	42973-45	171	44041-00	214	44099-02	321
42958-29	293	42973-60	171	44041-01	214	44099-03	321
42959-12	286	42973-61	171	44041-03	214	44100-01	321
42959-13	286	42975-02	317	44041-04	214	44100-02	321
42960-18	365	42979-00	287	44041-05	214	44100-04	321
42961-12	362	42979-36	287	44042-00	214	44101-03	324
42961-14	361	42979-45	287	44043-00	214	44102-24	320
42961-18	362	42980-01	378	44044-00	214	44103-03	321
42961-23	361	42980-02	378	44047-17	212	44103-04	321
42961-31	364	42981-32	378	44047-19	212	44103-06	321
42962-04	365	42981-73	378	44047-22	212	44104-01	317
42962-26	365	42988-00	355	44047-25	212	44104-02	317
42962-44	365	42988-01	355	44047-28	212	44105-00	319
42963-40	365	42988-02	355	44048-99	340	44106-12	323
42963-55	365	42988-03	354	44049-01	340	44106B05	323
42964-53	200	42988-99	354	44049-02	340	44106B10	323
42964-60	200	42990-16	176	44055-10	325	44106B20	323
42965-12	175	42990-20	176	44055-20	325	44106B25	323
42965-AA	174	42990-29	176	44055-25	325	44106G05	323
42965-AB	174	42990M16	176	44055-30	325	44106G10	323
42967-03	173	42990M20	176	44055-35	325	44106G20	323
42967-04	173	42990M29	176	44055-40	325	44106G25	323
42967-05	173	42990N16	176	44055-50	325	44106G05	323
42967-06	173	42990N20	176	44056-01	325	44106O10	323
42967-07	173	42990N29	176	44056-04	325	44106O20	323
42967-08	173	42991-25	176	44056-06	325	44106O25	323
42967-11	174	42991-32	176	44057-04	325	44106R05	323
42967-13	173	42991M25	176	44057-06	325	44106R10	323
42967-14	173	42991M32	176	44058-10	326	44106R20	323
42967-15	173	42991N25	176	44058-20	325	44106R25	323
42967-16	173	42991N32	176	44058-25	325	44106W05	323
42967-17	173	42992-28	176	44058-30	325	44106W10	323
42967-18	173	42992-40	176	44058-40	326	44106W20	323
42967-35	172	42992M28	176	44058-50	326	44106W25	323
42967-40	172	42992M40	176	44060-01	324	44106Y05	323

INDICE NUMERICO NUMERICAL INDEX NUMERISCH INDEX INDEX NUMERIQUE

Cod.	pag.	Cod.	pag.	Cod.	pag.	Cod.	pag.
44106Y10	323	44150-19	234	44201V10	30	44230S10	35
44106Y20	323	44151-00	234	44201V12	30	44230S14	35
44106Y25	323	44151-AA	234	44201W10	30	44231-14	35
44107B05	323	44151-AB	234	44201W12	30	44232S12	35
44107B10	323	44151-AC	234	44201Y10	30	44232S16	35
44107B20	323	44160-03	242	44201Y12	30	44232S20	35
44107B25	323	44161-00	241	44202-10	30	44233-16	35
44107G05	323	44164-00	241	44202B12	30	44233-20	35
44107G10	323	44165-35	241	44202N12	30	44234-12	35
44107G20	323	44165-40	241	44202N25	31	44234-16	35
44107G25	323	44165-50	241	44202N27	31	44234S12	36
44107O05	323	44166-28	241	44202N29	31	44234S16	36
44107O10	323	44167-13	241	44202O12	30	44235-16	36
44107O20	323	44168-12	241	44202R12	30	44236S28	36
44107O25	323	44169b06	241	44202R25	31	44236S34	36
44107R05	323	44169b14	241	44202R27	31	44237S15	36
44107R10	323	44169r06	241	44202R29	31	44238-15	36
44107R20	323	44169r25	241	44202V12	30	44239R16	31
44107R25	323	44170-00	242	44202W12	30	44240-08	36
44107W05	323	44170-01	242	44202Y12	30	44240S08	30
44107W10	323	44171-24	240	44203R20	31	44241-19	36
44107W20	323	44171-50	240	44203R24	31	44242-00	36
44107W25	323	44172-30	241	44203R28	31	44243-00	36
44107Y05	323	44173-00	240	44204R24	31	44244S30	37
44107Y10	323	44174-24	240	44204R28	31	44244S36	37
44107Y20	323	44174-30	240	44205-16	31	44245S32	36
44107Y25	323	44175-15	240	44205-20	31	44246S11	37
44108-01	323	44175-18	240	44205-24	31	44246S14	37
44108-02	323	44177-12	240	44205-28	31	44246S17	37
44110-00	326	44178-01	233	44207-16	31	44248S60	37
44110-01	326	44178-02	233	44207-20	31	44249S30	37
44110-02	326	44178-03	233	44207-24	31	44249S35	37
44110-03	326	44178-15	232	44207-28	31	44250S30	37
44110-04	326	44178-16	232	44208G00	32	44250S35	37
44110-05	326	44178-17	232	44208R00	32	44251-01	37
44110-06	326	44178-18	232	44209R26	32	44251-03	37
44111-02	326	44178-19	232	44209R32	32	44255-10	37
44112-01	326	44178-20	232	44210-26	32	44255-12	37
44112-02	326	44178-30	233	44210-32	32	44255-14	37
44114-01	326	44178-31	233	44210-42	32	44255-15	37
44114-02	326	44178-40	232	44210S26	32	44255-16	37
44114-03	326	44178-45	232	44210S32	32	44255-21	37
44115-15	326	44178-60	235	44210S42	32	44255-22	37
44115-30	326	44178-61	235	44211-22	31	44310-33	71
44118-10	326	44178-62	235	44211-26	31	44311-37	71
44118-20	326	44178-63	235	44211-30	31	44322-02	44
44118-25	326	44178-66	236	44212-30	33	44322-04	44
44118-30	326	44178-67	236	44213-24	33	44322-06	44
44118-35	326	44178-68	236	44213-36	33	44332-03	52
44118-40	326	44201-01	30	44214-25	33	44332-06	52
44118-50	326	44201-03	30	44215S16	32	44332B06	52
44119-01	326	44201-10	30	44216S16	32	44333-03	52
44119-02	326	44201B10	30	44217-45	32	44333-06	52
44119-03	326	44201B12	30	44218R30	33	44333B06	52
44119-04	326	44201N10	30	44218R40	33	44334-03	52
44119-06	326	44201N12	30	44219R26	33	44334-06	52
44130-01	324	44201N16	31	44220S24	33	44335-03	52
44130-02	324	44201N20	31	44221S30	33	44335-06	52
44130-03	324	44201N24	31	44222-20	33	44335B06	52
44135-02	324	44201N28	31	44222-28	33	44337-03	52
44141-01	235	44201N32	31	44222S20	33	44337-06	52
44141-03	235	44201O10	30	44222S28	33	44337B06	52
44142-40	235	44201O12	30	44223S19	36	44338-03	52
44147-00	235	44201R10	30	44224-22	34	44338-06	52
44147-01	235	44201R12	30	44224S22	34	44339-03	52
44147-02	235	44201R16	31	44225-22	34	44339-06	52
44147-03	235	44201R20	31	44226S30	34	44342-06	53
44148-00	234	44201R24	31	44227-30	34	44342B06	53
44148-01	234	44201R28	31	44228S23	34	44342G06	53
44149-03	234	44201R32	31	44229S20	35	44342O06	53

Cod.	pag.	Cod.	pag.	Cod.	pag.	Cod.	pag.
44342R06	53	44390-15	39	44455B09	122	44511-90	219
44342Y06	53	44390-18	39	44456-14	122	44511E21	218
44343-06	53	44390-23	39	44456B14	122	44511E63	218
44343B06	53	44391-12	39	44457-32	122	44511E90	218
44343G06	53	44394-18	39	44457B32	122	44512-34	219
44343O06	53	44394-21	39	44459-28	122	44512-42	219
44343R06	53	44395-18	39	44459B28	122	44512-63	219
44343Y06	53	44397-18	39	44460-24	123	44512-90	219
44344-06	53	44398-14	365	44460B24	123	44512E12	218
44344B06	53	44399-21	280	44461-20	122	44512E21	218
44344G06	53	44399-23	280	44461B20	122	44513-34	219
44344O06	53	44399-27	280	44462-25	122	44513-38	219
44344R06	53	44401-00	44	44462B25	122	44513-54	219
44344Y06	53	44412-00	44	44463-11	123	44513-63	219
44345-06	53	44421-00	44	44464-23	122	44513-90	219
44345B06	53	44422-00	44	44464-24	122	44513E12	218
44345G06	53	44423-00	44	44466-07	279	44513E21	218
44345O06	53	44430-60	428	44466-30	279	44521-16	219
44345R06	53	44430-61	428	44468-26	347	44521-21	219
44345Y06	53	44431-46	428	44468-45	347	44521-31	219
44346-06	53	44431-60	428	44468-80	347	44521E10	218
44347-06	53	44432-21	44	44470-04	277	44522-16	219
44347B06	53	44446-10	352	44470-11	277	44522-21	219
44347G06	53	44446-14	352	44470-12	277	44522-31	219
44347O06	53	44446-18	352	44470-13	277	44522E10	219
44347R06	53	44446B10	352	44470-14	277	44620-01	215
44347Y06	53	44446B14	352	44470-24	277	44620-02	215
44352-30	393	44446B18	352	44470-53	277	44620-03	215
44352-40	393	44447-10	352	44471-11	276	44620-04	215
44355-30	393	44447-14	352	44471-12	276	44620-05	215
44355-40	393	44447-18	352	44471-13	276	44620-06	215
44357-10	281	44447B10	352	44471-14	276	44620-07	215
44357-15	281	44447B14	352	44471-24	276	44620-14	215
44357B10	281	44447B18	352	44472-11	276	44620-17	215
44357B15	281	44448-18	352	44472-12	276	44624-03	215
44366-10	295	44448-25	352	44472-13	276	44624-04	215
44366-13	295	44448-30	352	44472-14	276	44624-05	215
44368-24	280	44448B18	352	44472-24	276	44624-06	215
44368-30	280	44448B25	352	44473-11	279	44624-07	215
44368-35	280	44448B30	352	44473-12	279	44625-04	215
44368-40	280	44449-30	351	44473-13	279	44625-05	215
44368-45	280	44449-32	351	44473-14	279	44625-06	215
44369-19	280	44449-33	351	44473-24	279	44625-07	215
44369-21	280	44449B30	351	44474-30	278	44625-08	215
44370-20	280	44449B32	351	44474-40	278	44625-26	215
44371-24	39	44449B33	351	44474-48	278	44625-34	215
44371-28	39	44450-11	121	44501-01	15	44801-09	227
44371-32	39	44450-12	121	44501-02	15	44801-18	227
44371-36	39	44450-13	121	44501-03	15	44802-21	225
44371-40	39	44450-15	121	44501-04	15	44802-31	225
44371-44	39	44450-17	121	44502-01	15	44807-18	227
44371-48	39	44450-21	121	44502-02	15	44807-28	227
44372-26	39	44450-23	121	44502-03	15	44807-36	227
44372-32	39	44450B12	121	44502-04	15	44819-02	228
44372-36	39	44450B14	121	44503-01	15	44819-03	228
44372-40	39	44450B16	121	44503-02	15	44820-80	228
44372-50	39	44450B17	121	44503-03	15	44820-99	228
44374-22	39	44450B21	121	44503-04	15	44822-80	228
44374-25	39	44450B24	121	44505-05	224	44822-99	228
44374-32	39	44451-22	121	44505-10	224	44825-20	228
44374-36	39	44451-23	121	44505-15	224	44825-40	228
44374-40	39	44451B23	121	44505-20	224	44826-08	227
44374-44	39	44451B24	121	44505-25	224	44826-20	228
44375-25	39	44452-31	122	44506-05	224	44830-52	226
44376-40	39	44452B31	122	44506-09	224	44830-72	225
44379-05	280	44453-14	122	44511-27	219	44830-99	225
44389-32	39	44453B14	122	44511-34	219	44831-52	225
44390-07	39	44454-11	122	44511-38	219	44832-52	226
44390-09	39	44454B11	122	44511-42	219	44832-99	226
44390-11	39	44455-09	122	44511-63	219	44833-52	226

INDICE NUMERICO NUMERICAL INDEX NUMERISCH INDEX INDEX NUMERIQUE

Cod.	pag.	Cod.	pag.	Cod.	pag.	Cod.	pag.
44833-99	226	44843-14	346	44871-13	213	44930-20	225
44834-00	350	44843-24	346	44871-14	213	44932-15	225
44834-01	350	44843B11	346	44871-20	212	44932-20	225
44834-02	350	44843B12	346	44871-20	337	44934-30	225
44834-03	350	44843B13	346	44871-21	212	44935-01	225
44834B00	350	44843B14	346	44871-21	337	44935-02	225
44834B01	350	44843B24	346	44871-22	212	44940-01	336
44834B02	350	44844-01	347	44871-23	212	44940-02	336
44834B03	350	44844-11	347	44871-30	273	44940-06	336
44834G00	350	44844b01	347	44871-31	273	44940-08	336
44834G01	350	44845-30	346	44871-AA	213	44940-10	336
44834G02	350	44845-31	329	44873-08	330	44940-11	336
44834G03	350	44845-37	330	44873-16	330	44940-12	337
44835-36	349	44845-38	329	44874-08	330	44940-13	337
44835-45	349	44845-41	346	44874-16	330	44940-14	337
44835-53	349	44845-51	346	44878-11	51	44940-16	337
44835B36	349	44845B38	346	44878-12	51	44940-17	337
44835B45	349	44845B51	346	44878-13	51	44940-18	337
44835B53	349	44846-05	348	44878-14	51	44940-19	337
44835G36	349	44846-09	348	44878-16	51	44940-24	337
44835G45	349	44846-13	348	44878-24	51	44940-25	337
44835G53	349	44846-15	348	44878B11	51	44940-26	337
44836-30	350	44846B05	348	44878B12	51	44940-32	337
44836-35	349	44846B09	348	44878B13	51	44940-33	337
44836B30	350	44846B13	348	44878B14	51	44940-34	337
44836B35	349	44846B15	348	44878B16	51	44942-01	338
44836G30	350	44847-09	347	44878B24	51	44942-02	338
44836G35	349	44847-13	347	44879-11	51	44942-03	338
44837-05	361	44847-20	347	44879-12	51	44942-04	338
44837-25	361	44847B09	347	44879-13	51	44942-05	338
44837B05	361	44847B13	347	44879-14	51	44942-06	309
44837B25	361	44847B20	347	44879-16	51	44942-07	309
44838-03	279	44848-26	347	44883-11	51	44942-10	309
44838-05	279	44848-53	347	44883-12	51	44942-11	309
44838-07	279	44849-01	348	44883-13	51	44942-12	309
44839-04	348	44849-02	348	44883-14	51	44946-01	289
44839-05	348	44849-27	349	44883-16	51	44946-02	289
44840-01	345	44849-34	349	44883-23	51	44946-03	290
44840-02	345	44849-47	349	44883-24	51	44946-04	377
44840-03	345	44850-00	349	44884-13	369	44946-05	377
44840-04	345	44850-01	349	44884-19	369	44946-06	290
44840-05	345	44850-10	348	44884-25	369	44946b01	289
44840-06	369	44850-11	348	44884B13	369	44946B05	377
44840-07	369	44850-12	349	44884B19	369	44946B06	290
44840-08	355	44850-13	348	44884B25	369	44947-00	199
44840-10	355	44850B00	349	44885-19	369	44947-01	342
44840-18	355	44850B10	348	44885-25	369	44947-02	342
44840-20	345	44850B11	348	44886-30	351	44947-03	321
44840-25	345	44850B12	349	44886-36	351	44947-04	343
44840-26	345	44850B13	348	44886-38	351	44947-05	342
44840-27	345	44850G12	349	44886-44	351	44947-06	330
44840-28	345	44850W00	349	44887-32	351	44947-07	83
44840-30	355	44851-01	349	44887-36	351	44947-08	343
44840-31	355	44851-02	349	44887-40	351	44947-09	343
44840-32	355	44851-03	349	44888-32	351	44950-15	280
44841-18	346	44852-01	356	44888-35	351	44950-20	280
44841-21	346	44852-02	356	44888-40	351	44950-25	280
44841-26	346	44871-00	212	44889-32	351	44950-30	280
44841-37	346	44871-01	213	44889-35	351	44950-38	280
44841-51	346	44871-02	213	44889-40	351	44960-06	164
44841B51	346	44871-03	213	44929-02	61	44968-00	221
44842-30	346	44871-04	213	44929-03	61	44969-00	221
44842-31	346	44871-05	213	44929-04	61	44969-01	221
44842-35	346	44871-06	213	44929-05	61	44970-10	220
44842-53	346	44871-07	213	44929-06	61	44970-15	220
44842B31	346	44871-08	213	44929-07	61	44970-20	220
44842B53	346	44871-09	213	44929-08	61	44970-34	220
44843-11	346	44871-10	213	44929-09	61	44971-01	222
44843-12	346	44871-11	213	44929-11	61	44971-02	222
44843-13	346	44871-12	213	44930-10	225	44971-03	222

Cod.	pag.	Cod.	pag.	Cod.	pag.	Cod.	pag.
44971-04	222	44998-31	72	47041-03	169	47100-04	376
44971-05	222	44999-09	273	47041-04	169	47100-05	376
44972-20	220	44999-16	273	47041-05	169	47100-06	376
44972-25	220	44999-25	273	47041-06	169	47100-07	376
44972-33	220	46970-18	17	47041-07	169	47100-08	376
44973-10	220	46970-25	17	47041-08	169	47100-09	376
44973-20	220	47005-24	443	47041-15	169	47101-30	427
44974-21	220	47006-25	443	47042-19	170	47101-31	329
44974-27	220	47007-26	447	47042-22	170	47101-40	427
44974-31	220	47010-20	426	47042-25	170	47103-30	427
44975-35	165	47011-01	437	47043-27	170	47103-32	427
44975-50	165	47014-30	445	47043-35	170	47104-34	426
44975C50	211	47014-35	445	47043-42	170	47104-40	426
44975H35	165	47018-30	445	47060-06	441	47104-46	426
44975H50	165	47018-50	445	47060-07	441	47104-50	426
44976-01	223	47020-15	423	47060-09	441	47105-28	425
44976-02	223	47020-20	423	47060-10	441	47105-34	425
44976-03	223	47020-30	423	47060-12	441	47105-40	425
44976-04	224	47020-35	423	47060-14	441	47105-46	425
44976-05	224	47021-35	423	47060-16	441	47105-50	425
44977-12	224	47021-45	423	47060-18	441	47105-55	425
44978-10	220	47022-12	436	47060-20	441	47105-60	425
44978-20	220	47023-01	316	47060-22	441	47105-65	425
44979-01	222	47023-02	316	47060-24	441	47105-70	425
44979-02	222	47023-03	316	47060-26	441	47105-75	425
44979-03	222	47023-04	316	47060-30	441	47106-28	425
44979-04	222	47024-06	433	47062-18	441	47106-34	425
44979-05	222	47024-10	433	47062-20	441	47106-40	425
44979-06	222	47025-06	433	47062-22	441	47106-46	425
44979-11	222	47025-10	433	47064-18	441	47106-50	425
44979-12	222	47026-06	433	47064-22	441	47106-55	425
44979-13	222	47027-11	434	47064-26	441	47106-60	425
44979-14	222	47027-12	434	47064-30	441	47106-65	425
44980-60	222	47027-13	434	47066-03	441	47106-70	425
44982-04	170	47027-14	434	47066-04	441	47106-75	425
44982-06	170	47027-15	434	47066-05	441	47107-00	427
44982-10	170	47027-16	434	47066-06	441	47108-00	427
44985-00	221	47028-12	433	47066-07	441	47110-23	425
44986-12	220	47029-12	433	47066-08	441	47111-30	426
44986-17	220	47030-30	434	47068-12	441	47111-40	426
44986-21	220	47031-44	430	47068-15	441	47111-46	426
44986-28	220	47031-46	430	47069-10	441	47111-55	426
44987-11	221	47032-10	434	47069-12	441	47112-34	426
44987-12	221	47032-20	434	47069-14	441	47112-45	426
44987-60	221	47033-08	434	47069-16	441	47112-50	426
44987C11	222	47033-12	434	47069-18	441	47113-03	427
44987C60	222	47033-14	434	47069-20	441	47118-30	426
44990-15	337	47033-50	431	47070-37	437	47118-40	426
44990-24	337	47034-23	435	47070-48	437	47118-55	426
44990-29	337	47034-50	435	47070-60	437	47118-65	426
44990-36	337	47034-51	435	47075-20	437	47119-30	425
44990-48	337	47034-52	435	47075-30	437	47119-35	425
44991-01	342	47035-40	434	47075-45	437	47119-40	425
44991-03	342	47035-48	434	47090-23	329	47119-45	425
44991-04	342	47036-30	434	47091-01	329	47119-50	425
44992-02	272	47036-35	434	47091-02	329	47119-60	425
44992-03	272	47036-40	434	47093-24	83	47127-04	423
44993-01	371	47036-45	434	47094-30	427	47127-06	423
44993-02	371	47036-50	434	47096-06	328	47127-08	423
44993-03	371	47036-60	434	47096-60	328	47130-25	437
44993-04	371	47037-30	435	47096-63	328	47130-30	437
44994-00	372	47037-40	435	47097-60	427	47130-35	437
44995-10	273	47038-50	434	47098-18	428	47130-40	437
44995-14	273	47038-60	434	47098-22	428	47130-45	437
44995-15	273	47039-05	435	47098-26	428	47130-50	437
44995-25	272	47039-10	435	47098-30	428	47130-55	437
44997-22	72	47039-15	435	47099-22	377	47130-60	437
44997-24	72	47040-00	169	47099-30	377	47131-30	437
44997-26	72	47041-01	169	47099-36	377	47131-60	437
44997-28	72	47041-02	169	47100-03	376	47200-01	423

INDICE NUMERICO NUMERICAL INDEX NUMERISCH INDEX INDEX NUMERIQUE

Cod.	pag.	Cod.	pag.	Cod.	pag.	Cod.	pag.
47200-02	423	47317-10	407	47357-25	418	47419-10	408
47207-01	423	47317-12	407	47357-26	419	47421-09	414
47207-02	423	47317-20	407	47357-27	419	47422-26	414
47207-03	424	47321-12	407	47357-28	419	47425-01	415
47207-04	424	47322-12	407	47357-29	419	47425-02	415
47207-05	424	47323-12	407	47357-30	419	47425-03	415
47207-06	424	47324-12	407	47357-31	419	47425-04	415
47207-08	424	47325-10	408	47370-01	413	47425-05	415
47207-09	424	47326-10	408	47370-02	413	47425-06	415
47207-10	424	47327-12	408	47370-03	413	47425-08	415
47207-20	423	47328-15	408	47370-08	409	47425-09	415
47207-25	423	47331-15	408	47371-08	412	47425-10	415
47207-30	423	47332-12	408	47372-08	410	47425-11	415
47208-01	422	47333-15	408	47373-01	410	47425-26	415
47208-02	422	47334-12	408	47373-02	413	47425-29	415
47208-03	422	47335-12	408	47373-08	410	47425-30	415
47208-04	422	47336-42	408	47374-01	413	47425-32	415
47208-05	422	47350-01	421	47374-02	413	47426-01	415
47208-06	422	47351-01	421	47374-08	413	47426-07	415
47208-07	422	47352-01	421	47375-01	412	47507-40	423
47208-08	422	47353-02	422	47375-08	412	47526-05	439
47208-09	422	47353-04	422	47376-08	410	47527-55	439
47208-10	422	47353-06	422	47377-01	411	47528-05	439
47208-11	422	47353-08	422	47377-02	411	47529-07	439
47208-12	422	47353-10	422	47377-03	411	47530-14	438
47208-13	422	47353-12	422	47377-04	411	47530-16	438
47208-14	422	47353-14	422	47377-05	411	47530-18	438
47208-15	422	47353-16	422	47377-06	411	47530-20	438
47208-16	422	47353-18	422	47377-07	411	47530-22	438
47208-17	422	47353-20	422	47377-08	409	47530-24	438
47208-18	422	47353-22	422	47377-09	411	47530-26	438
47208-19	422	47353-24	422	47377-10	411	47530-28	438
47208-20	422	47354-02	422	47377-11	411	47530-30	438
47208-21	422	47354-04	422	47378-01	413	47532-06	438
47208-22	422	47354-06	422	47378-02	413	47532-07	438
47208-23	422	47354-08	422	47378-08	409	47532-08	438
47208-24	422	47354-10	422	47379-08	409	47532-12	438
47212-01	422	47354-12	422	47380-08	412	47532-14	438
47212-02	422	47354-14	422	47381-08	413	47532-16	438
47212-03	422	47354-16	422	47382-01	412	47532-18	438
47214-86	425	47354-18	422	47382-08	410	47532-20	438
47215-86	425	47355-02	422	47383-08	412	47532-22	438
47216-88	425	47355-04	422	47384-01	412	47532-24	438
47219-29	423	47355-06	422	47385-01	413	47532-26	438
47219-38	423	47355-08	422	47385-08	413	47533-07	438
47219-55	423	47355-10	422	47386-08	412	47533-08	438
47250-12	425	47355-12	422	47387-01	410	47533-09	438
47250-24	425	47356-02	422	47387-02	410	47533-10	438
47251-00	424	47356-04	422	47401-08	412	47533-12	438
47251-01	424	47356-06	422	47402-01	410	47533-14	438
47251-02	424	47356-08	422	47402-02	410	47533-16	438
47251-03	424	47356-10	422	47402-03	412	47533-18	438
47301-12	407	47356-12	422	47402-08	410	47533-20	438
47302-10	407	47356-14	422	47404-01	412	47533-22	438
47303-10	407	47356-16	422	47404-02	412	47533-24	438
47303-19	255	47356-18	422	47404-04	412	47533-26	438
47304-06	407	47357-01	421	47404-05	412	47533-28	438
47304-10	407	47357-02	421	47404-08	412	47533-30	438
47304-12	407	47357-03	421	47411-01	409	47533-32	438
47305-12	407	47357-06	420	47411-02	410	47534-06	439
47306-10	407	47357-07	420	47411-03	410	47534-07	439
47307-10	407	47357-08	420	47411-08	409	47534-08	439
47308-10	407	47357-09	420	47412-08	409	47534-09	439
47310-10	407	47357-10	420	47413-01	409	47534-10	439
47312-10	407	47357-11	420	47413-08	409	47534-16	439
47314-10	407	47357-20	418	47414-03	408	47534-18	439
47315-10	407	47357-21	418	47415-03	408	47534-20	439
47316-10	407	47357-22	418	47416-06	408	47534-22	439
47316-12	407	47357-23	418	47417-06	408	47534-24	439
47316-20	407	47357-24	418	47418-00	408	47534-26	439

Cod.	pag.	Cod.	pag.	Cod.	pag.	Cod.	pag.
47534-28	439	47609-02	331	47652-01	451	47677-09	450
47535-09	440	47609-03	331	47652-02	451	47677-10	450
47535-12	440	47609-04	331	47652-03	451	47677-11	450
47535-15	440	47609-07	331	47652-04	451	47677-12	450
47535-17	440	47609-09	331	47652-05	451	47677-13	450
47535-19	440	47609-12	331	47652-07	451	47677-14	450
47536-12	440	47609-13	331	47655-01	451	47677-15	450
47536-14	440	47609-16	331	47655-02	451	47677-16	450
47536-16	440	47610-18	75	47655-03	451	47677-17	450
47536-18	440	47610-22	75	47655-04	451	47677-18	450
47536-20	440	47610-26	75	47655-05	451	47677-19	450
47538-20	440	47610-30	75	47655-07	451	47677-20	450
47538-23	440	47611-01	76	47656-01	451	47677-23	450
47538-26	440	47611-03	76	47656-02	451	47677-24	450
47540-02	440	47611-05	76	47656-03	451	47677-25	450
47540-03	440	47611-06	76	47656-04	451	47679-10	436
47540-04	440	47611-09	76	47656-05	451	47680-40	438
47540-05	440	47611-13	76	47656-07	451	47680-53	438
47541-02	439	47612-01	429	47657-01	451	47680-60	438
47541-03	439	47614-25	436	47657-02	451	47681-60	437
47541-04	439	47615-25	436	47657-03	451	47682-53	437
47542-18	440	47618-10	425	47657-04	451	47682-60	437
47542-20	440	47618-20	425	47657-05	451	47683-30	71
47542-22	440	47621-01	436	47657-07	451	47684-15	448
47544-20	440	47621-02	436	47658-01	451	47685-53	438
47544-25	440	47621-03	436	47658-02	451	47685-60	438
47544-30	440	47621-04	436	47658-03	451	47686-10	427
47546-18	439	47621-05	436	47658-04	451	47686-12	427
47546-30	439	47621-06	436	47658-05	451	47686-14	427
47546-40	439	47621-07	436	47658-07	451	47686-17	427
47547-22	440	47621-08	436	47659-01	434	47686-22	427
47547-26	440	47621-11	162	47659-02	434	47686-24	427
47547-30	440	47621-12	162	47659-03	434	47686-26	427
47548-02	439	47622-01	417	47659-04	434	47686-30	427
47548-03	439	47622-02	417	47670-02	448	47686-33	427
47548-04	439	47622-03	417	47672-05	448	47686-36	427
47548-05	439	47622-04	417	47674-01	449	47686-42	427
47600-16	76	47622-26	417	47674-02	449	47687-24	427
47600-20	76	47625-03	436	47674-03	449	47688-60	438
47600-24	76	47626-55	431	47674-04	449	47689-53	437
47600-28	76	47627-01	431	47674-05	449	47689-60	437
47600-32	76	47630-28	431	47674-06	449	47692-01	432
47600-36	76	47631-08	431	47674-07	449	47692-02	432
47600-40	76	47631-12	431	47674-08	449	47692-03	432
47601-26	72	47640-40	435	47675-01	449	47693-00	432
47602-01	71	47640-60	435	47675-02	449	47693-03	432
47602-02	71	47640-80	435	47675-03	449	47693-05	432
47602-03	71	47642-30	435	47675-04	449	47693-10	432
47602-04	71	47642-40	435	47675-05	449	47693-15	432
47602-25	71	47642-50	435	47675-06	449	47694-03	429
47602-27	71	47642-60	435	47675-07	449	47698-03	429
47602-31	71	47642-70	435	47675-08	449	47698-06	429
47603-27	72	47643-30	435	47675-09	449	47705-22	443
47604-08	72	47643-40	435	47676-01	461	47709-20	443
47604-10	72	47643-50	435	47676-02	461	47709-24	443
47604-12	72	47643-60	435	47676-03	461	47709-28	443
47604-15	72	47643-70	435	47676-04	461	47709-32	443
47604-18	72	47644-15	435	47676-05	461	47710-12	443
47604-20	72	47645-40	435	47676-06	461	47710-16	443
47604-24	72	47645-60	435	47676-07	461	47710-20	443
47604-30	72	47645-75	435	47676-08	461	47710-24	443
47605-23	71	47646-40	435	47676-09	461	47710-28	443
47606-02	72	47646-60	435	47677-01	450	47710-32	443
47606-05	72	47646-75	435	47677-02	450	47711-08	443
47606-10	72	47651-01	451	47677-03	450	47711-12	443
47606-20	72	47651-02	451	47677-04	450	47711-22	443
47606-30	72	47651-03	451	47677-05	450	47711-24	443
47606-50	72	47651-04	451	47677-06	450	47711-26	443
47607-10	72	47651-05	451	47677-07	450	47712-20	443
47607-20	72	47651-07	451	47677-08	450	47712-24	443

INDICE NUMERICO NUMERICAL INDEX NUMERISCH INDEX INDEX NUMERIQUE

Cod.	pag.	Cod.	pag.	Cod.	pag.	Cod.	pag.
47712-28	443	47740-14	470	47740-92	473	47742-09	464
47712-32	443	47740-15	471	47740-93	469	47742-10	463
47713-22	443	47740-16	473	47740-94	470	47742-12	462
47714-26	443	47740-17	468	47740-95	470	47742-13	464
47714-28	443	47740-18	474	47740-96	469	47742-14	464
47715-30	443	47740-19	473	47740-97	471	47742-15	463
47716-37	443	47740-20	470	47740-98	471	47742-16	463
47717-35	444	47740-23	468	47740-99	468	47742-17	464
47718-20	444	47740-24	470	47740100	472	47742-19	462
47719-10	444	47740-25	470	47740101	468	47742-20	462
47719-24	444	47740-26	469	47740102	469	47742-21	463
47720-06	444	47740-27	469	47740103	469	47742-23	464
47720-08	444	47740-28	469	47740104	473	47742-24	464
47720-10	444	47740-29	469	47740105	468	47742-25	462
47720-12	444	47740-30	472	47740106	468	47742-27	463
47721-08	444	47740-31	472	47740107	469	47742-28	463
47721-10	444	47740-32	472	47740108	469	47742-29	463
47721-12	444	47740-33	471	47740109	469	47742-30	463
47722-05	444	47740-34	471	47740110	469	47742-31	463
47722-06	444	47740-35	471	47740111	471	47742-32	462
47722-07	444	47740-36	471	47740112	467	47742-33	462
47722-08	444	47740-37	470	47740113	467	47742-34	462
47722-10	444	47740-38	470	47740114	467	47742-36	463
47723-05	444	47740-39	469	47740115	467	47742-37	463
47723-06	444	47740-41	468	47740116	467	47742-41	463
47723-07	444	47740-43	471	47740117	467	47742-42	463
47723-08	444	47740-44	471	47740118	467	47742-47	463
47723-10	444	47740-45	472	47740119	468	47742-48	463
47723-12	444	47740-46	472	47740121	466	47742-51	464
47724-06	444	47740-47	472	47740122	468	47742-56	464
47724-08	444	47740-48	472	47740123	468	47742-61	464
47724-10	444	47740-50	471	47740124	468	47743-65	475
47724-11	444	47740-51	473	47740125	468	47744-10	476
47725-09	444	47740-52	473	47740127	466	47744-19	476
47726-07	444	47740-53	471	47740128	466	47744-21	476
47727-07	444	47740-56	473	47740129	466	47744-30	475
47728-06	444	47740-57	473	47740130	466	47744-31	475
47730-24	445	47740-58	473	47740131	466	47744-32	475
47730-36	445	47740-59	473	47740132	466	47744-33	475
47730-60	445	47740-60	474	47740133	467	47744-34	475
47731-12	445	47740-61	474	47740134	467	47744-48	476
47732-20	445	47740-62	474	47740135	467	47744-60	476
47733-18	445	47740-63	473	47740136	467	47744-62	476
47733-24	445	47740-64	474	47740137	467	47744-63	476
47733-30	445	47740-65	474	47740138	467	47747-01	446
47733-36	445	47740-66	474	47740139	467	47747-03	446
47734-18	445	47740-67	473	47740140	474	47747-04	446
47735-18	445	47740-68	473	47740141	474	47747-05	446
47736-30	445	47740-69	473	47740142	466	47747-06	446
47736-35	445	47740-70	473	47740143	466	47747-07	446
47736-40	445	47740-71	474	47740144	466	47747-09	446
47736-50	445	47740-72	474	47740145	466	47747-10	446
47738-23	445	47740-73	474	47740-AA	472	47747-11	446
47739-12	445	47740-74	474	47740-AB	474	47748-35	446
47739-24	445	47740-75	474	47740-AC	474	47749-35	447
47739-28	445	47740-76	466	47740-AD	474	47750-06	447
47739-32	445	47740-77	466	47741-32	475	47751-23	448
47740-01	470	47740-78	466	47741-76	475	47752-09	447
47740-02	470	47740-79	468	47741-77	475	47752-16	447
47740-03	470	47740-80	468	47741-78	475	47752-21	447
47740-04	471	47740-81	466	47741121	475	47753-31	448
47740-05	474	47740-82	468	47742-00	464	47754-20	448
47740-06	473	47740-83	471	47742-01	463	47754-24	448
47740-07	471	47740-84	472	47742-02	463	47754-26	448
47740-08	472	47740-86	470	47742-03	463	47754-28	448
47740-09	470	47740-87	470	47742-04	463	47755-26	448
47740-10	470	47740-88	467	47742-05	463	47756-20	448
47740-11	472	47740-89	468	47742-06	464	47756-24	448
47740-12	469	47740-90	472	47742-07	464	47756-26	448
47740-13	469	47740-91	472	47742-08	462	47756-28	448

Cod.	pag.	Cod.	pag.	Cod.	pag.	Cod.	pag.
47757-65	446	47821-05	433	47860-71	454	47876-13	456
47757-80	446	47821-07	433	47860-73	454	47876-14	456
47758-10	446	47822-05	433	47860-74	454	47876-15	456
47758-12	446	47822-07	433	47860-75	454	47876-16	456
47759-12	446	47830-05	433	47860-81	453	47876-17	456
47760-12	446	47830-07	433	47860-83	453	47876-18	456
47761-23	447	47831-02	89	47860-84	453	47880R01	382
47761-30	447	47833-04	431	47860-85	453	47880R02	382
47762-23	447	47833-10	431	47860-90	456	47880R03	381
47763-31	446	47835-20	417	47860-91	456	47880R04	381
47764-10	447	47835-21	417	47860-92	456	47880R05	381
47764-12	447	47835-22	417	47860-93	456	47880R07	382
47764-28	447	47835-23	417	47860-94	456	47880R08	382
47765-26	464	47835-24	417	47862-35	453	47880R10	382
47765-28	464	47835-25	417	47862-36	453	47880R11	382
47768-24	464	47835-26	417	47862-37	453	47880R12	381
47770-21	464	47835-27	417	47863-01	455	47880R17	383
47772-24	464	47835-28	417	47863-02	455	47880R18	383
47773-24	464	47835-29	417	47863-03	455	47885-01	383
47773-28	464	47835-30	417	47863-04	455	47885-02	383
47780-01	461	47835-98	417	47865-23	456	47885-03	383
47780-02	461	47835-99	417	47865-44	456	47885-04	383
47780-03	461	47837-09	417	47865-66	457	47885-05	383
47780-04	461	47838-00	431	47865-71	457	47910-01	380
47783-01	452	47840-11	430	47865-72	457	47910-02	379
47783-02	452	47841-03	383	47865-73	457	47910-03	380
47783-03	452	47841-04	383	47865-74	457	47910-07	380
47783-04	452	47842-00	431	47865-75	457	47910-08	380
47783-11	452	47843-00	100	47865-76	457	47910-10	379
47783-12	452	47844-01	430	47865-77	457	47910-11	380
47783-13	452	47844-02	430	47865-80	456	47910-15	380
47783-14	452	47844-06	430	47865-81	456	47910-16	379
47784-05	464	47846-10	429	47865-82	456	47910-17	379
47784-07	464	47847-10	157	47865-83	456	47910-AA	379
47785-07	464	47847-12	157	47870-17	455	48017-14	189
47785-10	464	47847-23	157	47870-18	455	48017-25	189
47793-11	457	47848-07	429	47870-19	455	48021-21	189
47793-12	457	47859-01	316	47870-21	459	48032-30	194
47793-13	457	47859-02	316	47870-22	459	48032-45	194
47793-14	457	47859-03	316	47870-23	459	48032-60	194
47793-15	457	47860-17	454	47870-24	459	48038-10	195
47793-16	457	47860-18	454	47870-25	459	48039-06	194
47793-17	457	47860-21	454	47870-26	459	48040-00	194
47793-18	457	47860-24	454	47870-27	459	48040-10	194
47793-19	457	47860-27	454	47870-28	459	48040-50	195
47793-20	457	47860-31	453	47870-29	459	48040-AA	194
47793-21	458	47860-38	454	47870-30	459	48200-27	310
47793-22	458	47860-39	454	47870-31	459	48200-28	310
47793-23	458	47860-40	453	47870-32	460	48210-00	286
47793-24	458	47860-42	453	47870-33	459	48211-00	286
47793-25	458	47860-43	453	47870-34	460	48215-14	189
47793-26	458	47860-44	454	47870-35	460	48215-30	189
47793-27	458	47860-46	453	47870-36	460	48216-10	89
47793-32	458	47860-48	453	47870-37	460	48218-00	81
47793-33	458	47860-49	453	47870-38	460	48220-00	96
47793-40	458	47860-50	454	47870-39	460	48221-00	96
47793-41	458	47860-53	454	47870-40	460	48222-01	96
47793-42	458	47860-55	454	47870-41	460	48223-00	327
47793-43	458	47860-56	454	47870-42	460	48231-40	197
47793-44	458	47860-57	454	47870-43	460	48231-45	197
47793-45	458	47860-58	453	47870-44	460	48231-50	197
47793-51	458	47860-60	454	47875-01	440	48237-00	281
47793-52	458	47860-61	454	47875-02	440	48237-01	281
47793-53	458	47860-62	454	47875-03	440	48237-35	281
47793-54	458	47860-63	454	47875-04	440	48238-00	287
47793-55	458	47860-66	454	47875-11	451	48239-00	286
47800-22	429	47860-67	454	47875-13	451	48240-00	287
47801-10	429	47860-68	453	47875-14	451	48241-14	295
47820-05	433	47860-69	454	47876-11	456	48242-09	294
47820-07	433	47860-70	454	47876-12	456	48244-07	294

INDICE NUMERICO NUMERICAL INDEX NUMERISCH INDEX INDEX NUMERIQUE

Cod.	pag.	Cod.	pag.	Cod.	pag.	Cod.	pag.
48245-10	294	48278-81	119	48280-59	108	48300-24	338
48245-75	294	48278-82	119	48280-60	111	48300-25	338
48247-10	295	48278-83	119	48280-61	111	48300-27	339
48248-16	295	48278-84	119	48280-62	111	48300-28	339
48249-13	295	48278-85	118	48280-63	111	48300-29	126
48250-12	295	48278-86	118	48280-70	110	48300-30	126
48251-03	295	48278-87	115	48280-75	108	48300-31	126
48252-10	295	48278-88	119	48280-80	110	48300-32	126
48252-12	295	48278-89	119	48280-85	111	48300-33	126
48252B10	295	48278-90	114	48280-90	112	48300-34	339
48252B12	295	48278-91	117	48280-91	112	48300-35	339
48253-09	295	48278-92	117	48280-92	112	48300-36	339
48253B09	295	48278-93	118	48280-93	112	48300-37	339
48278-01	115	48278-94	115	48280-94	109	48300-38	339
48278-02	115	48278-95	116	48280-95	112	48300-39	339
48278-03	115	48278-96	116	48280-96	111	48300-40	339
48278-11	117	48278-99	117	48280-97	111	48300-41	339
48278-12	117	48280-02	109	48281-22	85	48306-01	340
48278-13	113	48280-03	96	48281-23	85	48306-02	340
48278-14	119	48280-04	107	48282-21	86	48307-01	340
48278-15	117	48280-05	107	48283-00	89	48307-02	340
48278-16	116	48280-06	109	48283-01	89	48307-03	340
48278-17	116	48280-07	109	48283-02	89	48307-04	340
48278-18	119	48280-08	111	48283-03	89	48345-02	340
48278-19	119	48280-09	109	48283-04	89	48345-04	340
48278-20	115	48280-10	81	48283-05	89	48350-01	311
48278-21	115	48280-11	112	48284-00	89	48350-02	311
48278-24	113	48280-12	109	48285-04	87	48350-03	311
48278-25	116	48280-13	109	48285-05	87	48350-04	311
48278-26	119	48280-15	111	48286-01	90	48351-01	311
48278-27	118	48280-16	112	48286-03	90	48351-02	311
48278-29	119	48280-18	110	48286-05	89	48351-03	311
48278-30	119	48280-19	110	48286-08	89	48352-01	311
48278-31	115	48280-20	107	48286-09	190	48352-02	311
48278-32	114	48280-21	108	48286-13	90	48352-03	311
48278-33	114	48280-22	108	48286-18	90	48353-01	311
48278-34	116	48280-23	112	48286-28	91	48354-01	311
48278-35	116	48280-24	109	48286-45	91	48355-01	341
48278-36	116	48280-25	112	48286-46	90	48356-01	341
48278-37	115	48280-26	110	48286-47	90	48357-01	341
48278-38	114	48280-27	110	48286-48	91	48358-01	341
48278-39	114	48280-28	109	48286-60	89	48359-01	341
48278-41	115	48280-29	109	48286-61	112	48360-01	341
48278-42	114	48280-30	109	48286-62	84	48361-01	341
48278-43	114	48280-31	109	48286-63	84	48362-01	340
48278-45	114	48280-32	107	48286-64	84	48363-01	340
48278-46	114	48280-34	111	48286-65	85	48364-09	340
48278-47	116	48280-35	109	48286-66	85	48364-12	340
48278-48	114	48280-36	109	48286-68	287	48365-09	311
48278-49	114	48280-37	108	48286-70	87	48366-09	311
48278-52	116	48280-38	108	48286-71	87	48501-76	203
48278-53	116	48280-39	107	48286-72	87	48505-01	203
48278-54	116	48280-41	108	48287-10	90	48505-02	203
48278-55	114	48280-42	108	48287-18	331	48505-03	203
48278-61	118	48280-43	108	48287-19	331	48506-01	203
48278-62	117	48280-44	112	48287-20	89	48506-02	203
48278-63	118	48280-45	107	48289-10	83	48506-03	203
48278-64	117	48280-46	108	48290-10	170	48510-00	203
48278-65	118	48280-47	111	48294-01	91	48511-02	203
48278-66	117	48280-48	107	48294-02	91	48512-02	203
48278-68	117	48280-49	108	48294-03	91	48513-02	203
48278-69	117	48280-50	112	48294-04	91	48514-00	204
48278-70	117	48280-51	107	48294-12	91	48516-07	204
48278-71	118	48280-52	111	48295-08	87	48516-08	204
48278-72	118	48280-53	111	48295-10	85	48516-09	204
48278-73	118	48280-54	110	48295-11	87	48517-03	203
48278-74	118	48280-55	107	48300-20	338	48518-01	204
48278-75	115	48280-56	108	48300-21	338	48518-02	204
48278-76	118	48280-57	109	48300-22	338	48518-03	204
48278-77	115	48280-58	107	48300-23	338	48519-01	204

Cod.	pag.	Cod.	pag.	Cod.	pag.	Cod.	pag.
48519-02	204	49381-01	216	49627-22	126	49655-41	125
48519-03	204	49381-02	216	49628-00	126	49656-02	129
48519-04	204	49381-03	216	49629-45	132	49656-15	128
48520-20	205	49382-10	216	49630-06	127	49656-16	128
48520-23	205	49382-23	216	49630-08	127	49656-20	128
48520-30	205	49382-47	216	49631-08	131	49657-15	129
48522-24	204	49383-00	216	49631-11	131	49657-20	129
48523-01	203	49384-03	216	49632-24	131	49657-25	129
48523-02	203	49384-04	216	49632-32	131	49658-01	126
48523-03	203	49384-05	216	49633-22	131	49658-02	126
48523-04	203	49384-06	216	49633-24	131	49701-00	101
48524-75	205	49384-07	216	49634-00	132	49702-00	100
48525-03	205	49384-11	216	49635-00	132	49703-00	430
48526-44	205	49384-14	216	49636-00	131	49703-01	430
48527-00	205	49384-15	216	49637-00	131	49705-00	100
48528-00	205	49600-00	129	49638-00	131	49710-00	100
48529-00	205	49601-14	131	49640-09	123	49712-00	100
48530-01	202	49602-25	129	49641-12	123	49715-00	101
48530-02	202	49602-30	129	49642-07	123	49716-00	101
48530-03	202	49602-33	129	49642-09	123	49717-00	102
48530-04	202	49602-35	129	49643-02	124	49718-00	102
48530-05	202	49603-15	128	49644-00	123	49720-00	103
48531-01	202	49603-20	128	49644-22	123	49729-00	102
48531-02	202	49603-25	128	49645-25	123	49730-00	103
48531-03	202	49603-30	128	49647-15	123	49731-00	103
48531-04	202	49603-40	128	49647-18	123	49732-00	103
48531-05	202	49603-50	128	49647-20	123	49739-00	195
48536-01	202	49604-31	128	49647-23	123	49741-07	195
48536-02	202	49604-36	128	49647-25	123	49741-15	195
48536-03	202	49604-41	128	49648-15	123	49750-00	82
48536-04	202	49605-46	129	49648-18	123	49752-00	86
48536-05	202	49605-61	129	49648-20	123	49753-06	87
48536-06	202	49605-71	129	49648-23	123	49753-09	87
48536-07	202	49606-00	130	49648-25	123	49756-00	94
48536-08	202	49606-01	130	49648-36	123	49760-00	79
48536-09	202	49606-51	130	49648-40	123	49762-01	80
48540-00	202	49607-15	132	49649-20	123	49762-02	80
48541-00	201	49607-20	132	49649-23	123	49762-03	80
48542-01	202	49607-25	132	49649-25	123	49762-04	80
48543-01	201	49607-30	132	49649-30	123	49762-05	80
48543-02	201	49608-15	132	49649-36	123	49762-06	80
48544-02	202	49608-20	132	49649-40	123	49762-07	80
49304-06	212	49608-25	132	49655-01	127	49762-08	80
49336-00	238	49608-30	132	49655-02	127	49762-09	80
49336-02	238	49608-35	132	49655-03	128	49762-10	80
49336-05	239	49609-12	132	49655-08	127	49790-09	396
49337-00	239	49609-14	132	49655-10	127	49791-50	158
49337-01	239	49610-11	132	49655-11	127	49792-09	158
49339-65	239	49610-14	132	49655-13	124	49800-15	10
49340-20	239	49612-30	128	49655-14	127	49807-00	143
49371-09	243	49612-33	128	49655-16	127	49808-00	143
49371-12	243	49613-30	129	49655-20	125	49808-AC	143
49373-01	217	49613-33	129	49655-21	124	49808-AD	143
49373-02	217	49613-35	129	49655-22	124	49811-00	98
49373-03	217	49614-28	130	49655-23	124	49812-00	98
49373-04	217	49615-01	131	49655-24	125	49814-00	98
49373-05	243	49615-03	131	49655-25	125	49817-00	82
49373-11	217	49616-22	131	49655-26	125	49818-00	81
49373-12	217	49616-24	131	49655-27	126	49818-AC	81
49373-13	217	49616-26	131	49655-28	125	49818-AD	81
49373-14	217	49616B01	130	49655-29	124	49818-AE	81
49373-90	217	49616S01	130	49655-30	126	49818-AF	81
49374-01	217	49617-23	132	49655-31	125	49819-00	81
49374-02	217	49617-25	132	49655-32	125	49819-01	81
49374-11	217	49617-30	132	49655-34	124	49819-02	81
49374-12	217	49618-12	131	49655-35	124	49819-03	81
49374-90	217	49618-15	131	49655-36	124	49819-04	81
49378-00	230	49618-18	131	49655-37	124	49821-08	80
49378-48	236	49626-00	127	49655-38	130	49823-00	88
49379-00	230	49626-02	127	49655-40	125	49823-89	88

INDICE NUMERICO NUMERICAL INDEX NUMERISCH INDEX INDEX NUMERIQUE

Cod.	pag.	Cod.	pag.	Cod.	pag.	Cod.	pag.
49823-99	88	49850-31	142	49875-06	194	49931A01	237
49826-99	88	49850-33	137	49876-03	199	49931A02	237
49827-03	89	49850-36	140	49877-12	196	49931B01	237
49827-99	88	49850-37	141	49879-37	96	49931B02	237
49829-11	86	49850-38	141	49880-10	101	49931B03	237
49830-60	86	49850-39	141	49880-11	101	49931B05	237
49831-00	365	49850-41	141	49880-12	101	49931C04	237
49832-02	84	49850-42	141	49880-13	101	49933-30	236
49832-10	84	49850-45	156	49880-14	101	49933-50	236
49833-00	365	49850-46	156	49880-15	101	49933-68	236
49834-00	82	49850-48	141	49881-01	102	49933-90	236
49834-10	82	49850-53	154	49883-00	101	49934-04	238
49835-00	82	49850-54	154	49884-08	102	49934-06	238
49836-00	82	49850-55	154	49885-02	100	49934-08	238
49837-01	81	49850-56	154	49887-00	100	49934-14	238
49837-05	80	49850-57	154	49888-10	77	49934-16	238
49838-08	82	49850-59	137	49888-20	77	49934-18	238
49838-98	82	49850-60	137	49889-15	75	49940-01	145
49839-00	80	49850-61	137	49889-18	75	49940-02	146
49840-00	94	49850-63	153	49889-21	75	49940-03	146
49840-01	94	49850-65	139	49889-30	75	49940-AA	148
49840-02	95	49850-66	139	49890-02	238	49940-AB	148
49840-03	95	49850-67	141	49890-05	238	49940-AC	148
49840-04	95	49850-68	141	49892-40	243	49940-AD	148
49840-05	95	49850-69	140	49895-87	236	49940-AE	148
49840-06	95	49850-70	140	49896-00	236	49940-AF	148
49840-07	95	49850-71	139	49896-04	236	49940-AG	148
49840-20	95	49850-72	139	49896-05	236	49940-AH	148
49840-30	95	49850-73	138	49897-09	243	49940-AI	148
49840-31	95	49850-74	139	49898-30	243	49940-AL	148
49840-32	95	49850-75	138	49899-01	243	49940-AM	148
49840-33	95	49850-76	138	49899-02	243	49940-AN	148
49840-34	95	49851-10	157	49899-03	243	49940-AO	148
49841-00	94	49852-20	105	49899-04	243	49940-AP	148
49842-00	81	49853-01	105	49899-05	243	49940-AQ	148
49843-00	83	49853-03	105	49907-01	143	49940-AR	148
49843-05	96	49855-05	394	49907-06	143	49940-AS	148
49844-01	94	49855-10	394	49907-AA	143	49940-AT	148
49845-01	78	49855-15	394	49907-AB	143	49940-AU	148
49847-08	396	49856-04	394	49911-19	144	49940-AV	148
49847-16	396	49856-10	394	49911-24	144	49940-AY	148
49848-05	395	49857-00	328	49911-30	144	49940-AZ	148
49848-10	395	49858-00	327	49911-35	144	49940-BA	148
49848-15	395	49858-01	327	49911-45	144	49940-BB	148
49848-BA	395	49858-06	327	49916-25	144	49940-BD	148
49848-BB	395	49858-07	328	49916-35	144	49940-BE	148
49849-00	94	49859-00	328	49916-45	144	49940-BF	148
49850-01	140	49860-00	327	49916-55	144	49940-BG	148
49850-03	142	49861-00	98	49920-00	154	49940-BH	148
49850-06	140	49861-01	98	49921-00	154	49940-BI	148
49850-10	140	49861-10	98	49921-10	154	49940-BL	148
49850-11	137	49862-00	98	49922-01	149	49940-BM	148
49850-12	138	49863-10	105	49922-02	149	49940-BN	148
49850-13	137	49863-15	105	49922-03	149	49940-BO	148
49850-14	137	49863-30	105	49922-04	149	49940-BP	148
49850-15	140	49863-50	105	49922-06	150	49940-BQ	148
49850-16	140	49863-95	105	49922-08	150	49940-BR	148
49850-18	136	49863-99	105	49922-09	151	49941-AA	148
49850-19	136	49864-03	104	49922-14	151	49941-AB	148
49850-20	139	49864-05	104	49922-20	151	49941-AC	148
49850-21	136	49864-20	105	49922-21	151	49941-AD	148
49850-22	136	49865-06	104	49922-22	151	49941-AE	148
49850-23	136	49865-70	104	49922-23	151	49941-AF	148
49850-24	142	49866-01	105	49931-00	237	49941-AG	148
49850-25	142	49866-02	105	49931-01	237	49941-AH	148
49850-26	142	49866-05	105	49931-60	237	49941-AI	148
49850-27	142	49871-10	195	49931-64	237	49941-AL	148
49850-28	142	49871-20	195	49931-65	237	49941-AM	148
49850-29	142	49872-00	195	49931-87	237	49941-AN	148
49850-30	142	49873-26	195	49931A00	237	49941-AO	148

Cod.	pag.	Cod.	pag.	Cod.	pag.	Cod.	pag.
49941-AP	148	49999-03	156	56120-22	288	58166-EC	387
49941-AQ	148	51595B44	79	56120-24	288	58166-ED	387
49941-AR	148	51595B45	79	56123-00	290	58166-EG	387
49941-AS	148	52550-01	268	56162-00	285	58166-EH	387
49941-AT	148	52550-02	268	56163-27	285	58166-EI	387
49941-AU	148	52550-03	270	56163-30	285	58166-EL	387
49941-AV	148	52550-04	270	56796-00	327	58166-EM	387
49941-AY	148	52550-05	270	58132A54	390	58166-KE	387
49941-AZ	148	52550-06	270	58132A55	390	58166-KP	387
49942-01	146	52550-07	270	58132-AE	387	58166-KU	387
49942-02	146	52550-09	270	58132-AU	387	58166E24	388
49942-03	147	52550-11	268	58132E54	390	58166E30	388
49943-01	147	52550-12	268	58132E55	390	58166E36	388
49943-02	147	52550-13	268	58132-FA	393	58166E40	388
49944-01	147	52550-14	268	58132-FB	393	58166U24	388
49944-02	147	52550-15	268	58132-KA	387	58166U36	388
49945-05	153	52550-16	268	58132-KE	393	58166U40	388
49946-01	147	52550-17	269	58132-KU	393	58168A24	388
49947-08	153	52550-18	269	58132U54	390	58168E24	388
49949-09	150	52550-19	270	58132U55	390	58168-GA	388
49949-14	150	52550-20	268	58136A33	390	58168U24	388
49949-19	153	52550-21	268	58136A34	390	58172-54	385
49949-20	145	52550-22	268	58136A40	390	58172-56	385
49949-25	145	52550-23	268	58136A41	390	58172A54	389
49952-00	158	52550-24	268	58136E33	390	58172A56	389
49952-AA	158	52550-25	268	58136E34	390	58172E54	389
49952-AB	158	52550-26	268	58136E40	390	58172E56	389
49952-AC	158	52550-30	268	58136E41	390	58172U54	389
49953-02	153	52550-33	269	58136-EA	393	58172U56	389
49954-01	153	52550-34	268	58136-EB	393	58176-30	385
49954-18	128	52550-36	269	58136-KA	387	58176-36	385
49954-19	157	52550-37	269	58136-KE	393	58176-40	385
49954-20	396	52550-41	269	58136-KU	393	58176A30	388
49954-21	128	52550-42	269	58136U33	390	58176A36	388
49954-22	158	52550-43	270	58136U34	390	58176A40	388
49954-25	395	52550-50	267	58136U40	390	58176E30	388
49955-01	152	52550-53	268	58136U41	390	58176E36	388
49956-01	152	52550-54	268	58152A54	391	58176E40	388
49957-00	152	52550-55	268	58152E54	391	58176U36	388
49958-00	152	52550-56	267	58152U54	391	58176U40	388
49959-00	152	52550-58	267	58156A33	391	58341-EC	393
49960-00	152	52550-60	267	58156A40	391	58341-EM	393
49985-00	101	52550-62	267	58156E33	391	58341-ET	393
49986-00	101	52550-63	267	58156E40	391	58341-EW	393
49987-00	102	52550-64	267	58156U33	391	58341-KE	387
49987-17	395	52550-66	267	58156U40	391	58341-KU	387
49988-00	101	52550-68	267	58162-54	385	58351A06	391
49991-11	396	52550-69	267	58162-56	385	58351A09	391
49991-21	396	52550-70	267	58162A54	389	58351A12	391
49991-31	396	52550-73	267	58162A56	389	58351A18	391
49992-11	396	52550-74	267	58162-KE	387	58353-17	374
49992-21	396	52550-77	267	58162-KU	387	58355E06	391
49992-31	396	52550-78	267	58162-RA	155	58355E09	391
49994-01	402	52550-79	267	58162-RB	155	58355E12	391
49994-02	402	52550-80	267	58162E54	389	58355U06	391
49994-03	402	52550-81	267	58162E56	389	58355U09	391
49994-04	403	52550-83	267	58162U54	389	58355U12	391
49995-01	403	52550-84	267	58162U56	389	58357E06	394
49995-02	403	52550-85	267	58166-24	385	58357E09	394
49995-03	403	52550-87	267	58166-30	385	58357E12	394
49995-04	229	52550-88	267	58166-36	385	58402-33	368
49997-12	155	52550-89	267	58166-40	385	58402-40	368
49997-13	155	52550-91	267	58166A24	388	58874-11	398
49998-02	156	56020-85	250	58166A30	388	58874-22	398
49998-03	155	56020-99	250	58166A36	388	58875-00	399
49998-04	156	56024-85	250	58166A40	388	58876-00	398
49998-05	156	56024-99	250	58166-AA	385	58876-01	398
49998-20	155	56116-15	320	58166-AB	385	58877-00	398
49999-01	156	56118-20	288	58166-AC	385	58878-00	399
49999-02	156	56120-18	288	58166-AM	385	58879-00	399

FOTO - PHOTO

Riccardo Bianchi
Dario Muzzarini

STAMPA - PRINT

Rotolito Lombarda S.p.A.

© COPYRIGHT

- Ogni riproduzione anche parziale del presente catalogo è vietata se non espressamente autorizzata per iscritto da Sambonet Paderno Industrie S.p.A.
- This catalogue may not be reproduced in whole or in part unless specific prior written authorization of Sambonet Paderno Industrie S.p.A.
- Die Vervielfältigung dieses Katalogs -auch wenn partial- ohne unsere ausdrückliche schriftliche Erlaubnis ist untersagt.
- Toute reproduction ou reproduction partielle de ce catalogue est interdite sauf expressément autorisée par Sambonet Paderno Industrie S.p.A.
- Queda prohibida la reproducción total o parcial de este catálogo sin autorización de forma expresa y por escrito de Sambonet Paderno Industrie S.p.A.

NOTE - NOTES

- Le misure, caratteristiche ed illustrazioni dei prodotti sono indicative e soggette a variazioni senza preavviso qualora esigenze tecnico produttive lo richiedessero.
- The pictures illustrated and data are representatives. We reserve the right to alter at any time the specifications stated without notice, whenever technical requirements shall so demand.
- Fotos und Abmessungen sind nur als information zu verstehen. Wir behalten uns das Recht vor, die angegebenen Spezifikationen jederzeit zu ändern, sofern es aus produktionstechnischen Gründen erforderlich ist.
- Les photos et dimensions indiquées sont indicatives. Nous nous réservons le droit de modifier à tout moment les spécifications techniques, si la situation l'exige.
- Fotos, datos y medidas que aparecen en este catálogo son indicativos y susceptibles, sin previo aviso, de modificación por exigencias técnicas o de producción.



PADERNO
WORLD CUISINE

© Sambonet Paderno Industrie S.p.A.

www.paderno.it
www.hotel.paderno.it

XA9002 - Ed. 10/2015



8 014808 935022